



**AGENDA
CITY OF CEDAR FALLS, IOWA
PLANNING AND ZONING COMMISSION MEETING
WEDNESDAY, MAY 08, 2019
5:30 PM AT CITY HALL**

Call to Order and Roll Call

Approval of Minutes

1. Planning and Zoning Commission Minutes of April 24, 2019.

Public Comments

Old Business

- 2. College Hill Neighborhood Overlay District - Site Plan Review: 2119 College Street (DEFERRED)**

Location: 2119 College Street, 925 W. 22nd Street, & 1003 W. 22nd Street

Applicant: CV Commercial, LLC., Owner; Slingshot Architects, Architect

Previous discussion: November 28, 2018, December 12, 2018, January 9, 2019

Recommendation: Recommend Approval

P&Z Action: Item deferred until City Council considers proposed zoning code amendments for the College Hill Overlay Zoning District.

New Business

3. **Western Home Ninth Addition Preliminary Plat**

Location: Western Home Communities South Main Street Campus

Applicant: Western Home Communities

Previous discussion: None

Recommendation: Review and continue discussion

P&Z Action: Review and continue discussion at the May 22nd P&Z Meeting

4. **PO-1 Site Plan Review – All Smiles Dental Clinic**

Location: Lot 2 Schofield Stevenson Office Park

Applicant: Fehr Graham and Levi Architecture

Previous discussion: None

Recommendation: Recommend approval

P&Z Action: Review and make a recommendation to City Council

5. **MPC Site Plan Review**

Location: 5601 University Avenue

Applicant: Lori and Kyle Larson

Previous discussion: None

Recommendation: Recommend approval

P&Z Action: Review and make a recommendation to City Council

6. **Rezoning Request from R-3 to C-2**

Location: 2600 Grove Street

Applicant: City of Cedar Falls
Previous discussion: None
Recommendation: Review and continue discussion
P&Z Action: Review and set a date of public hearing on May 22nd P&Z meeting

7. HWY-1 District Site Plan

Location: Lot 2 Gateway Business Park Subdivision
Applicant: Martin Rouse, Fehr Graham, Peters Construction, AHTS Architects
Previous discussion: None
Recommendation: Review and continue discussion
P&Z Action: Review and continue discussion at the May 22nd P&Z meeting

Commission Updates

Adjournment

Reminders:

- * May 22nd and June 12th Planning & Zoning Commission Meetings
- * May 20th and June 3rd City Council Meetings

**Cedar Falls Planning and Zoning Commission
Regular Meeting
April 24, 2019
City Hall Council Chambers
220 Clay Street, Cedar Falls, Iowa**

MINUTES

The Cedar Falls Planning and Zoning Commission met in regular session on Wednesday, April 24, 2019 at 5:30 p.m. in the City Hall Council Chambers, 220 Clay Street, Cedar Falls, Iowa. The following Commission members were present: Adkins, Giarusso, Hartley, Holst, Larson, Leeper, Oberle, Saul and Wingert. Shane Graham, Planner II was also present.

- 1.) Chair Holst noted the Minutes from the April 10, 2019 regular meeting are presented. Mr. Leeper made a motion to approve the Minutes as presented. Mr. Hartley seconded the motion. The motion was approved unanimously with 9 ayes (Adkins, Giarusso, Hartley, Holst, Larson, Leeper, Oberle, Saul and Wingert), and 0 nays.
- 2.) The first item of business was the College Hill Neighborhood Overlay District site plan review for 2119 College Street. The item was deferred to the next meeting.
- 3.) The next item for consideration by the Commission was the Furn Subdivision preliminary and final plat. Chair Holst introduced the item and Mr. Graham provided background information. He explained that he would go through the plat and site plan (the next item on the agenda) items at the same time. He noted that the property is located in the former Younkers store at College Square Mall and it is proposed to subdivide the store and the parking area. He stated that all requirements have been met in the plats and discussed easement relocation since the last meeting. He also addressed stormwater management. Staff recommends approval of the plats with the following stipulations: two signed deeds of dedication, two signed certificates of survey and six full size signed copies of the final plat prior to City Council submittal, as well as any comments or direction from the Planning and Zoning Commission.

Mr. Graham then discussed the proposed site plan for Ashley Homestore, noting the site details and that all requirements have been met. He again discussed the relocation of the easement as well as parking lot repairs that will be required. He provided a rendering of the required landscaping details and noted that the developer is requesting an amendment to the landscaping plan that was included with the Development Agreement with College Square Realty, LLC. The proposed landscaping plan provided by the developer would replace the landscaping shown on the original landscape plan for the mall for this site only. This request to amend the development agreement will be reviewed by City Council. He also displayed the proposed sidewalk area and stormwater management details. Mr. Graham showed building and façade renderings as well. Staff recommends approval of the site plan subject to any additional comments or directions specified by the Commission.

Troy Eichmann, COO for Ashley Homestore, stated that the variation on the landscaping would allow for better visibility, as that is an important factor to success.

Ms. Saul made a motion to approve the preliminary and final plats. Ms. Adkins seconded the motion. The motion was approved unanimously with 9 ayes (Adkins, Giarusso, Hartley, Holst, Larson, Leeper, Oberle, Saul and Wingert), and 0 nays.

Mr. Hartley stated that he is very excited for the project. Ms. Prideaux asked about the landscaping variance, and asked if one additional tree could be planted in order to meet the

parking lot landscaping requirement. Mr. Eichmann indicated that it was an oversight on his part and that he would add an additional tree to the site per Ms. Prideaux's request. Mr. Leeper noted that he was also happy about the project but feels that the development agreement with the mall should still be upheld. Mr. Graham indicated that the development agreement with College Square Mall would still be in tact.

Mr. Hartley made a motion to approve the site plan. Mr. Wingert seconded the motion. The motion was approved unanimously with 9 ayes (Adkins, Giarusso, Hartley, Holst, Larson, Leeper, Oberle, Saul and Wingert), and 0 nays.

- 4.) As there were no further comments, Ms. Saul made a motion to adjourn. Mr. Hartley seconded the motion. The motion was approved unanimously with 9 ayes (Adkins, Giarusso, Hartley, Holst, Larson, Leeper, Oberle, Saul and Wingert), and 0 nays.

The meeting adjourned at 5:57 p.m.

Respectfully submitted,

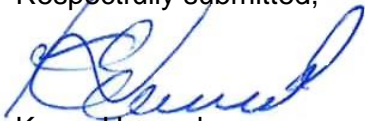

Karen Howard
Planning and Community Services Manager



Joanne Goodrich
Administrative Clerk



DEPARTMENT OF COMMUNITY DEVELOPMENT

City of Cedar Falls
220 Clay Street
Cedar Falls, Iowa 50613
Phone: 319-273-8606
Fax: 319-273-8610
www.cedarfalls.com

MEMORANDUM

Planning & Community Services Division

TO: Planning & Zoning Commission
FROM: David Sturch, Planner
DATE: May 2, 2019
SUBJECT: Western Home Communities Ninth Addition Preliminary Plat

REQUEST: Request to approve the Western Home Communities Ninth Addition Preliminary Plat. (Replat of a part of Western Home Communities Seventh Addition) Case #PP19-005

PETITIONER: Western Home Communities, Claassen Engineering

LOCATION: The property is located on 18.33 acres of land as the southwest corner of Prairie Parkway and Prairie View Road in the Western Home Campus on S. Main Street

PROPOSAL

Western Home Communities is proposing another phase for condominium/villa development along the south side of Prairie View Road. The Western Home Communities Ninth Addition will create 18 lots intended for retirement two unit/condos, similar to the recent development that has occurred on nearby Caraway Lane, Sweet Basil Lane and Shooting Star Way. The lots are similar in size from the previous phases, typically ranging from 0.33 acres to 0.6 acres. New streets extending south off of Prairie View Road include Caraway Lane (Tract A) and Savory Lane (Tract B). All street are to be constructed to 31 ft. paving width.

BACKGROUND

The Final Plat for the Western Home Communities Seventh Addition was approved by the Planning and Zoning Commission in the spring of 2015 and by the City Council in the fall of the same year. The seventh addition created 17 lots to allow the construction of the new Diamond Event Center and Jorgensen Plaza. Caraway Lane was installed as a private 29-foot wide roadway extending south of Prairie View Road approximately 225 feet to access the aforementioned Diamond Event Center. The seventh addition also created additional lots for



new two unit condos on Sweet Basil Lane and Shooting Star Way. Finally, included in the Seventh Addition was a large 16.7 acre tract located at the southwest corner of Prairie View Road and Prairie Parkway. This tract was set aside for future development of the Western Home Communities South Main Street campus. The proposed ninth addition is essentially a replat of the aforementioned tract in the Western Home Seventh Addition.

ANALYSIS

Western Home Communities proposes to plat 18.33 acres of land at the southwest corner of Prairie View Road and Prairie Parkway. It is anticipated the area will continue with the development of the condominium/villas. The property is located in the MU District which permits this type of development. The Commission has reviewed the proposed condos/villas in the past and the plan is to construct similar units in the proposed ninth addition.

Tracts A, B, D are reserved for street right of way and Tract C is for future development. Tract A is the proposed extension of Caraway Lane to serve as access to Lot 1 – 5. Caraway Lane would become a public street. At the south end of Caraway Lane, the roadway turns to the east and then north for Tract B where Savory Lane connects back into Prairie View Road. At this time, Western Home has no plans to add additional condos/villas in Tract C. With no development plans identified for Tract C, planned access locations must be established for this large vacant parcel. Prairie Parkway to the east is a “controlled” roadway with limited access locations which is established at the Prairie Parkway and Prairie View Road roundabout. Access to the south is not an option since this is an undeveloped commercial lot that is associated with the Pinnacle Prairie Commercial South development. This leaves the access locations onto Prairie View Road to the north and the proposed Savory Lane to the west. The access location on the north side of Tract C (Prairie View Road) must line up with the existing street locations of Sweet Basil Lane and Shooting Star Way. Access to the west is encouraged through one of the lots along the east side of Savory Lane. Tract C should connect to Savory Lane somewhere between Lots 13 and 16 as the location of a future road in the event that additional condos/villas are constructed in Tract C. It is important to provide multiple street connections to adjacent lots for adequate access, traffic flow and emergency response

TECHNICAL COMMENTS

City technical staff, including Cedar Falls Utilities (CFU) personnel, noted that the water, gas and communication services are available to the site. The developer will be responsible for extending the utility services to the proposed development. The easements identified on the plat satisfy CFU requirements. Drainage easements are identified on the plat between Lots 1 through 10, and along the south and east edge of the plat. The 30’ drainage easement along the west side of Prairie Parkway is subject to overland flows and must not be impeded. Future site plan review of this area will require restrictions on the placement of any landscaping and vegetation.

City zoning staff notes that the proposed lots appear to be of sufficient lot area to meet the anticipated development plans. The MU District is more flexible than other districts in terms of minimum lot area, lot width, etc. The MU district allows a 20 foot setback adjacent to all roadways and a 30 foot setback is permitted around the MU district boundary. Zero side lot line setbacks are allowed. The proposed plan will be similar to the previous additions in the Western Home development. The front yard setbacks will be 20 feet and the setback along the district boundary on the south side of this plat is 39 feet, due to a drainage and utility easement. It is anticipated that these lots will be developed in the traditional manner with adequate front, rear and side yard setbacks.

The property is located outside of the designated 100-year floodplain.

Approval of a Preliminary Plat allows the developer to proceed with the construction and installation of all required public infrastructure such as streets, sewers and other utilities. No lot sales or new home construction can begin until a Final Plat is approved by the City Council. The platting documents including the Deed of Dedication, City Council resolution forms and a plat fee of have been submitted.

STAFF RECOMMENDATION

The Community Development Department recommends approval of the Western Home Communities Ninth Addition Preliminary Plat with the stipulations:

- 1) Any comments or direction specified by the Planning & Zoning Commission.
- 2) All public streets and road are 31-foot wide from back of curb to back of curb.
- 3) Access from Savory Lane to Tract C should be provided between Lots 13 and 16.
- 4) Label all easements and building setbacks on the plat.
- 5) Conform to all city staff recommendations and technical requirements.

PLANNING & ZONING COMMISSION

Discussion/Vote

5/8/2019

Preliminary Plat

WESTERN HOME COMMUNITIES NINTH ADDITION

A Replat of a part of Western Home Communities Seventh Addition,
+ a part of Western Home Communities Eight Addition,
Cedar Falls, Black Hawk County, Iowa
April 2019

LEGAL DESCRIPTION:

Western Home Communities Ninth Addition

Tract 'E', Western Home Communities Seventh Addition, Document No. 2016-16744 in the Black Hawk County Recorder's Office, Cedar Falls, Black Hawk County, Iowa.

AND

That part of Lot Sixteen (16), aforesaid Western Home Communities Seventh Addition, described as follows:

Beginning at the Southeast corner of said Lot Sixteen (16); thence N00°31'08"W One Hundred Thirty-four and Six Hundredths (134.06) feet along the East line of said Lot Sixteen (16); thence S89°28'52"W Two Hundred Twenty-five (225.00) feet to the West line of said Lot Sixteen (16); thence S00°31'08"E One Hundred Fifty-six and Twenty-eight Hundredths (156.28) feet along said West line; thence Southerly Twenty-three and Ninety-seven Hundredths (23.97) feet along the Southwesterly line of said Lot Sixteen (16) and along the arc of a curve concave Northeasterly having a radius of Fifteen (15.00) feet and a chord of Twenty-one and Fifty Hundredths (21.50) feet which bears S46°18'09"E; thence Easterly Two Hundred Thirteen and Sixty-five (213.65) feet along the Southerly line of said Lot Sixteen (16) and along the arc of a curve concave Northerly having a radius of Seven Hundred Twenty (720.00) feet and a chord of Two Hundred Twelve and Eighty-seven Hundredths (212.87) feet which bears N79°24'47"E to the point of beginning containing 0.82 acres.

AND

That part of Lot One (01) and Lot Two (02) Western Home Communities Eight Addition, described as follows:

Beginning at the Northeast corner aforesaid Lot One (01); thence S00°31'08"E Seventy-six and Twenty-four Hundredths (76.24) feet along the East line of said Lot One (01); thence S89°28'52"W Sixty (60.00) feet along said East line; thence N00°31'08"W Seventy-six and Twenty-four Hundredths (76.24) feet along the Northerly extension of the East line of said Lot One (01) to the North line of said Lot One (01); thence continue N00°31'08"W One Hundred Thirty-five and Sixty-one Hundredths (135.61) feet still on said Northerly extension to the East line of aforesaid Lot Two (02); thence N89°28'52"E Fifty-five and Seventy-two Hundredths (55.72) feet along said East line; thence Easterly Four and Twenty-eight Hundredths (4.28) feet along said East line and along the arc of a curve concave Northerly having a radius of Seven Hundred Eighty-four (784.00) feet with a chord of Four and Twenty-eight Hundredths (4.28) feet which bears N89°19'29"E; thence S00°31'08"E One Hundred Thirty-five and Sixty-two Hundredths (135.62) feet along the East line of aforesaid Lot Two (02) to the point of beginning containing 12,711 square feet.

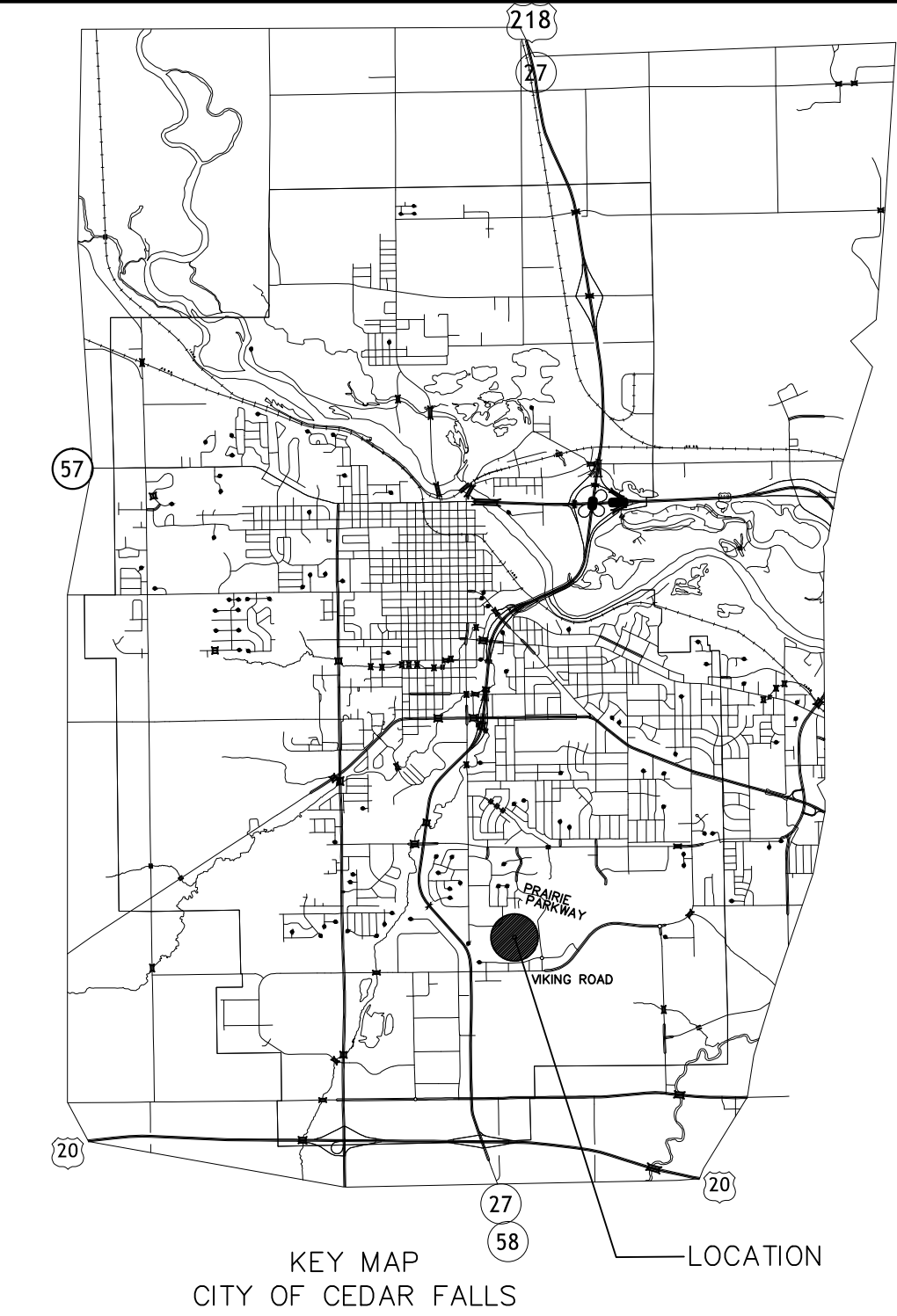

LIST OF OWNERS LOCATED WITHIN 200 FEET OF PROPERTY

| | |
|---|---|
| ① | GREENHILL ESTATES (ATTN: JESSICA SUK) 3957 75th STREET AURORA, IL 60504-7914 |
| ② | WALMART STORES INC. #1496 525 BRANDLYNN BL. CEDAR FALLS, IOWA 50613 |
| ③ | WESTERN HOME INDEPENDENT LIVING SERVICE INC. 420 E. 11th STREET (ATTN: KELLY MEIER CFO) CEDAR FALLS, IOWA 50613 |
| ④ | MENARD INC. 1125 BRANDLYNN BLVD. CEDAR FALLS, IOWA 50613 |
| ⑤ | OSTER FAMILY LIMITED PARTNERSHIP 3957 75th STREET AURORA, IL 60504-7914 |

| CURVE TABLE | | | | | DIMENSIONS IN FEET | |
|-------------|----------|-----------|-------------|----------|--------------------|--|
| CURVE | LENGTH | RADIUS | DELTA | CHORD | CHORD B. | |
| C1 | 17.94 | 50.00 | 20°33'34" | 17.85 | S10°47'56"E | |
| C2 | 39.27 | 25.00 | 90°00'00" | 35.36 | S44°28'52"W | |
| C3 | 39.27 | 25.00 | 90°00'00" | 35.36 | S45°31'08"E | |
| C4 | 39.47 | 110.00 | 20°33'34" | 39.26 | N10°47'55"W | |
| C5 | 60.06 | 784.00 | 04°23'21" | 60.04 | S66°43'36"W | |
| C6 | 32.37 | 50.00 | 37°05'35" | 31.81 | S19°03'55"E | |
| C7 | 97.96 | 720.00 | 7°42'44" | 97.89 | S84°00'59"W | |
| C8 | 115.69 | 720.00 | 9°12'23" | 115.57 | S75°30'55"W | |
| C9 | 213.65 | 720.00 | 17°00'07" | 212.87 | N79°24'47"E | |
| | (213.65) | (720.00) | (17°00'07") | (212.87) | (S79°24'47"W) | |
| C10 | 66.56 | 784.00 | 04°51'11" | 66.54 | S52°20'52"W | |
| C11 | 23.97 | 15.00 | 91°34'02" | 21.50 | S46°18'09"E | |
| | (23.97) | (15.00) | (91°34'02") | (21.50) | (N46°18'09"W) | |
| C12 | 432.63 | 3053.00 | 08°07'09" | 432.27 | S05°58'44"W | |
| | (432.63) | (3053.00) | (08°07'09") | (432.27) | (S05°58'44"W) | |
| C13 | 280.63 | 466.00 | 34°30'15" | 276.41 | N67°10'04"E | |
| | (280.63) | (466.00) | (34°30'15") | (276.41) | (N67°10'04"E) | |
| C14 | 133.45 | 784.00 | 09°45'11" | 133.29 | S59°39'22"W | |
| C15 | 140.83 | 784.00 | 10°17'31" | 140.64 | N84°01'21"E | |
| C16 | 136.21 | 784.00 | 09°57'17" | 136.04 | N73°53'57"E | |
| C17 | 248.26 | 866.00 | 16°25'31" | 247.41 | S06°11'07"W | |
| | (248.26) | (866.00) | (16°25'31") | (247.41) | (S06°11'07"W) | |
| C20 | 4.28 | 784.00 | 00°18'46" | 4.28 | N89°19'29"E | |
| | (4.28) | (784.00) | (00°18'46") | (4.28) | (N89°19'29"E) | |

BENCHMARK:

- NORTH BOLT OF FIRE HYDRANT LOCATED 56' NORTH OF CENTER OF SECTION, 31' WEST OF CENTERLINE S. MAIN STREET. ELEVATION = 955.15

LOT AREAS:

| LOT NO. | AREA | LOT NO. | AREA |
|---------|---------------|---------|---------------|
| 1 | (17,113 S.F.) | 17 | (18,935 S.F.) |
| 2 | (14,420 S.F.) | 18 | (16,778 S.F.) |
| 3 | (14,420 S.F.) | | |
| 4 | (14,420 S.F.) | | |
| 5 | (17,021 S.F.) | 'A' | (32,374 S.F.) |
| 6 | (17,021 S.F.) | 'B' | (48,859 S.F.) |
| 7 | (14,420 S.F.) | 'C' | (8.90 Ac.) |
| 8 | (14,420 S.F.) | 'D' | (12,711 S.F.) |
| 9 | (14,420 S.F.) | | |
| 10 | (20,687 S.F.) | | |
| 11 | (26,260 S.F.) | | |
| 12 | (14,655 S.F.) | | |
| 13 | (14,655 S.F.) | | |
| 14 | (14,655 S.F.) | | |
| 15 | (14,655 S.F.) | | |
| 16 | (16,031 S.F.) | TOTAL | (17.83 Ac.) |

GENERAL NOTES:

- Developer: Western Home Communities (Contact: Kris Hansen) 420 E. 11th Street Cedar Falls, Iowa 50613 Phone: 319.277.2141
- Owner: Western Home Independent Living Services, Inc. 420 E. 11th Street Cedar Falls, Iowa 50613 (Tract 'F' is right-of-way owned by the City of Cedar Falls)
- Engineer/Surveyor: Wayne Claassen Engineering and Surveying, Inc. 2705 University Ave. (P.O. Box 898) Waterloo, Iowa, 50704 Phone: 319.235.6294
- The unadjusted error of closure for this project was less than 1 in 10,000.
- Area of final plot in aliquot part: NE 1/4, SE 1/4, SEC. 25-T89N-R14W 10.74 ACRES NW 1/4, SW 1/4, SEC. 30-T89N-R13W 5.97 ACRES
- Electrical service shall be by Cedar Falls Utilities.
- Gas service shall be by Cedar Falls Utilities.
- Cable television service shall be by Cedar Falls Utilities AND Mediacom.
- Telephone service shall be by Qwest.
- Existing Zoning: see plot.
- Flood information of subject property: This Preliminary Plat is located Zone x which is areas determined to be outside the 0.2% annual chance floodplain. Firm Flood Insurance Rate Map Community-Panel number 19013C0277F, effective date July 18, 2011.
- Soil types present at subject property: (from soil survey of Black Hawk County, Iowa) A.) Kenyon loam, 2-5% slopes
- Pavement for this project shall be 31' b/b wide, 7" thick p.c.c. paving with integral curbs, with a 6" thick granular subbase and longitudinal subdrain, except for the existing pavement on Caraway Lane which shall remain 29' b/b.
- Sanitary sewer sizing to be completed during construction plan preparation.
- Storm sewer sizing to be completed during construction plan preparation.
- Water main diameter 8".
- All proposed sidewalks are 6 feet in width and will be constructed as adjoining buildings are constructed.
- A 10' wide recreational trail will be constructed along the Southerly side of Prairie View Road as building are constructed.

LEGEND:

- △ - DENOTES SECTION CORNER
- (0.00') - DENOTES RECORD DIMENSION
- 0.00' - DENOTES FIELD DIMENSION
- S.F. - DENOTES SQUARE FEET

| | |
|--|----------------------------|
| CERTIFICATION | |
| I hereby certify that this land surveying document was prepared and the related survey work was performed by me or under my direct personal supervision and that I am a duly Licensed Land Surveyor under the laws of the State of Iowa. | |
| Signature: _____ | David L. Schell, P.L.S. |
| Date: _____ | 20 _____ License No. 16775 |
| Pages or Sheets Covered by this Set: _____ | Sheets 1 of 2 and 2 of 2 |
| My license renewal date is December 31, 2020 | |

Wayne Claassen Engineering and Surveying, Inc.



2705 University Avenue • P.O. Box 898 • Waterloo, Iowa 50701
Phone: (319) 235-6294 Fax: (319) 235-0028

Preliminary Plat
WESTERN HOME COMMUNITIES NINTH ADDITION

A Replat of a part of Western Home Communities Seventh Addition,
+ a part of Western Home Communities Eight Addition,
Cedar Falls, Black Hawk County, Iowa
March 2019

sheet
1 of 2
4514P

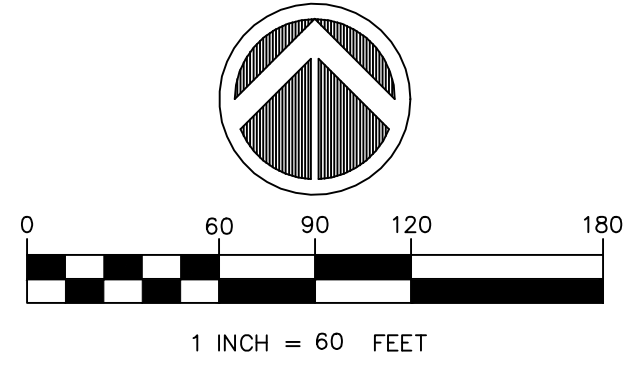

Preliminary Plat

WESTERN HOME COMMUNITIES NINTH ADDITION

A Replat of a part of Western Home Communities Seventh Addition,
+ a part of Western Home Communities Eighth Addition,
Cedar Falls, Black Hawk County, Iowa
April 2019

LEGEND:

- Δ - DENOTES SECTION CORNER
- (0.00') - DENOTES RECORD DIMENSION
- 0.00' - DENOTES FIELD DIMENSION
- S--- - DENOTES EXISTING STORM SEWER LINE
- SAN--- - DENOTES EXISTING SANITARY SEWER LINE
- WAT--- - DENOTES EXISTING WATER LINE
- ⊙ - DENOTES EXISTING SAN. SEWER MANHOLE
- ☆ - DENOTES LIGHT POLE
- ⊠ - DENOTES ELECTRIC BOX
- ⊞ - DENOTES TELEVISION BOX
- ⊠ - DENOTES TELEPHONE BOX
- ⊠ - DENOTES FIRE HYDRANT
- ⊠ - DENOTES WATER VALVE
- S--- - DENOTES PROPOSED SANITARY SEWER LINE
- WAT--- - DENOTES PROPOSED WATER LINE
- S--- - DENOTES PROPOSED STORM SEWER
- - - - - DENOTES EXISTING CONTOUR LINE
- (000) - DENOTES PROPOSED CONTOUR LINE

WESTERN HOME COMMUNITIES
EIGHTH ADDITION

WESTERN HOME COMMUNITIES
EIGHTH ADDITION

GENCOM ADDITION

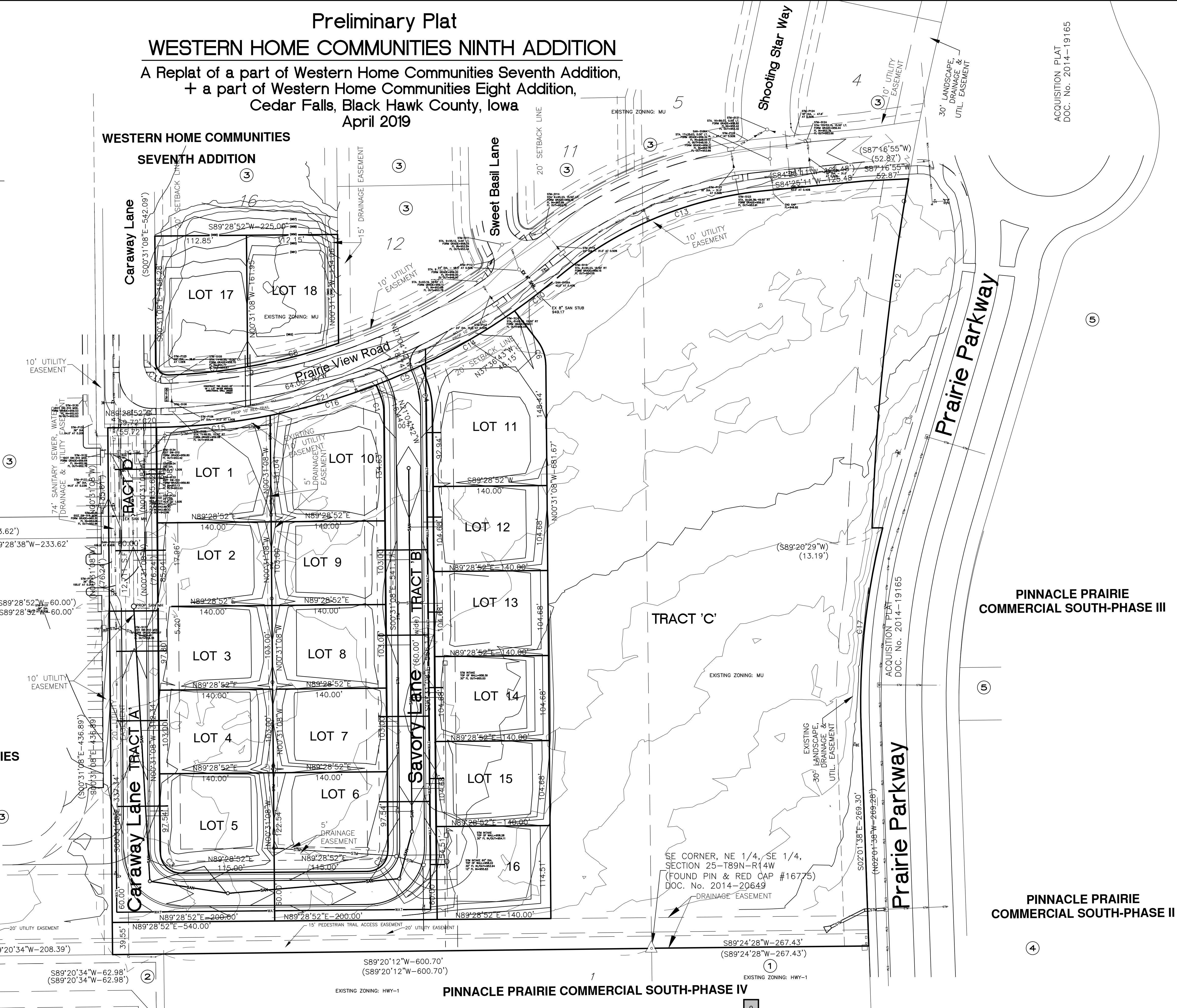

ACQUISITION PLAT
DOC. No. 2014-19165

**Wayne Claassen Engineering and
Surveying, Inc.**

2705 University Avenue • P.O. Box 898 • Waterloo, Iowa 50701
Phone: (319) 235-6294 Fax: (319) 235-0028

| BK. | PG. | 1 | DR. | D.L.S. | DATE | 02.15 |
|---|----------|----------|--------------------------|--------|------|-------|
| 4514P | 04.29.19 | FILE NO. | CK'D | W.J.C. | DATE | 02.15 |
| DATE PLOTTED: 04.29.19 FILENAME: WHC 9th Pre Plat.DWG | | | | | | |
| REVISIONS | | | | | | |
| 1. | 03.27.19 | - | Revised areas | | | |
| 2. | 04.29.19 | - | Remove to be vacated r/w | | | |
| 3. | | | | | | |
| 4. | | | | | | |
| 5. | | | | | | |

Preliminary Plat
WESTERN HOME COMMUNITIES NINTH ADDITION
A Replat of a part of Western Home Communities Seventh Addition,
+ a part of Western Home Communities Eighth Addition,
Cedar Falls, Black Hawk County, Iowa
March 2019

Preparer: Mark F. Conway c/o Swisher & Cohrt, PLC,
P.O. Box 1200, 528 W. 4th St., Waterloo, IA 50704

(319) 232-6555 Phone
(319) 232-4835 Fax

DEED OF DEDICATION
WESTERN HOME COMMUNITIES NINTH ADDITION
CEDAR FALLS, IOWA

KNOW ALL PERSONS BY THESE PRESENTS:

That the undersigned, Western Home Services, Inc., an Iowa nonprofit corporation, being desirous of laying out and platting into lots and tracts the real estate described in the Certificate of Survey prepared by David L. Scheil, a Registered Land Surveyor, dated the ____ day of _____ 2019, attached as Exhibit “A” do by these presents, designate and set apart the real estate described in the plat showing location and numbers and letters of lots and names and locations of streets as a subdivision of the City of Cedar Falls, in Black Hawk County, Iowa, the same to be known hereafter and called Western Home Communities Ninth Addition, Cedar Falls, Iowa (at times herein, the “Ninth Addition”), all of which is with the free consent and desire of the undersigned. The owners do hereby grant and convey to the City of Cedar Falls, its successors and assigns and to any private corporation, firm or person furnishing utilities for the transmission and/or distribution of water, sanitary sewer, gas, electricity, communication service or cable television, perpetual easements for the erection, laying, building and maintenance of such services over, across, on and/or under the property as shown on the attached plat.

ADJACENT SUBDIVISIONS AND UNPLATTED PARCELS

The Western Home Communities Ninth Addition was formerly described as Tract “E” in the Western Home Communities Seventh Addition. The Ninth Addition will be bordered on the west by Caraway Lane and the existing the Prairie Winds / Jorgensen Plaza development in the Western Home Communities Eighth Addition; on the north by residential villas in the Western Home Communities Seventh Addition; on the south by the Gencom Subdivision (Walmart) and Pinnacle Prairie Commercial South – Phase IV Subdivision (Greenhill Estates, Inc. & Hobby Lobby); and on the east by the remaining unplatted portion of Tract “E” and Tract “C” owned by Western Home Services, Inc. The east border of the Ninth Addition is known as Prairie Parkway. Prairie View Road runs between Prairie Parkway on the east and Caraway Lane on the west and will serve as the northern border of the Ninth Addition. Caraway Lane will extend from the north to south along

the western border of the Ninth Addition. All streets provide public access to, from and within the Ninth Addition.

COVENANTS AND RESTRICTIONS

The undersigned do also covenant and agree for themselves, and their successors and assigns, that each and all of the lots in the subdivision shall be, and the same are hereby made subject to the following restrictions upon their use and occupancy as fully and effectively to all intents and purposes as if the same were set forth and contained in each deed of conveyance or mortgage that the undersigned or its successors in interest may hereafter make for any of the lots, and that such restrictions shall run with the land and with each individual lot thereof for the length of time and in the particulars hereinafter stated, to-wit:

1. All lots and tracts shall be known as and available for such uses as may be permitted under the zoning regulations of the City of Cedar Falls, in effect at that time, as may be amended from time to time, except as otherwise restricted in this Deed of Dedication.
2. Structures are restricted to those allowed in Mixed Use Residential Zoning Districts and as may be permitted under the applicable zoning regulations of the City of Cedar Falls, as may be amended from time to time, except as otherwise restricted in this Deed of Dedication.
3. Each portion of the property shall be made subject to the covenants, restrictions, easements, obligations, and other provisions of that certain Charter for Pinnacle Prairie Commercial Properties recorded prior to the conveyance of the property (such Charter, as it may be amended from time to time in accordance with its terms, is referred to herein as the "Charter"). The Charter shall be binding upon the owners, lessees, and occupants of each portion of the property made subject to the Charter and any other person or entity holding any interest in such property, as well as their respective guests and invitees. The record owner of each lot or condominium unit within the property subject to the Charter shall, upon acquisition of title to such lot or unit, automatically become a member of a mandatory membership owners association as identified in the Charter (the "Association"), and shall remain a member as long as he/she/it holds title to such property. Membership in the Association shall be appurtenant to and may not be separated from ownership of such lot or condominium unit. The Association shall be organized to perform such obligations and exercise such powers as are assigned and granted to it in the Charter and its articles of incorporation and bylaws, which may include, without limitation, administering and enforcing the Charter, the design guidelines adopted pursuant thereto, and such reasonable rules as the Association may adopt consistent with the Charter, and maintenance of common areas and other property as authorized in the Charter and supplements thereto. Each record owner shall have such voting rights in the Association and such liability for a share of the common expenses of the Association as described in the Charter and the by-laws of the Association. The financial obligations of each record owner to the Association shall be a personal obligation of such owner and shall be secured by a lien in favor of the Association against the owner's property under the Charter.
4. The subdivision is in the Central Service Area of the Charter for Pinnacle Prairie Commercial Properties. Responsibility for maintenance costs within this service area is

detailed on Exhibit “B”, the same previously acknowledged by the City in its approval of the Western Home Communities Seventh Addition. Responsibility for maintaining drainage and detention basins within this service area is detailed on Exhibit “C”, the same previously acknowledged by the City in its approval of the Western Home Communities Seventh Addition.

5. Any and all drainage easements shall be required to follow the "Stormwater Management Plan" on record with the City of Cedar Falls Engineer's Office. No building structures, fence structures, landscaping structures, private gardens or any other possible obstruction shall be built in and over such drainage easements. All lot owners and/or contractors working on such lots will be responsible to maintain such easements and keep the same free and clear of any physical obstruction(s) thus allowing the conveyance of overland storm water runoff as intended per the City’s Stormwater Management Plan.
6. No grading or other construction shall be performed on any lot in the subdivision that blocks the flow of surface drainage water.
7. Any footing drain tiles, roof-leaders, sump pump systems installed in conjunction with the construction of a residence shall be expelled into the front, rear, or side yard or longitudinal sub-drains in the street and shall not be expelled into any sanitary sewer system or directly onto the street.
8. All buildings to be erected on any lot shall be constructed within building lines as indicated on the plat, and within City of Cedar Falls building and zoning ordinances.
9. No trailer, basement, tent, shack, garage, barn or other outbuilding in the tract shall at any time be used as a residence temporarily or permanently nor shall any residence of a temporary character be permitted.
10. The titleholder of each lot and tract, vacant or improved, shall keep the same free of weeds and debris.
11. No obnoxious or offensive trade shall be carried on upon any lot or tract, nor shall anything be done thereon which may be or become an annoyance or nuisance to the neighborhood.
12. All subsequent owners of lots in the subdivision shall be obligated to meet any requirements imposed by the Commissioners of the Black Hawk County Conservation District or any other governmental agency, by the authority of Chapter 467A, Code of Iowa, as amended by the 73rd General Assembly, pertaining to soil erosion control plans for certain land disturbing activities. This covenant shall be perpetual and shall run with the land.
13. Mailboxes shall be clustered in a common neighborhood monument-type mailboxes arrangement as required by the United States Postal Department.
14. The Developer shall perform the construction duties necessary to establish the common area, green spaces, entrance, retention pond(s) and surrounding access areas. The Developer shall initially maintain the common area, green spaces, entrance retention pond(s) and surrounding access of the development (whether located in such subdivision or serving such subdivision but located outside thereof). Such ownership and maintenance shall include, without limitation, common neighborhood monument-type mailboxes, mowing, watering, including upkeep of any underground sprinkler systems, snow removal

of common areas, maintenance of any retention pond(s) and/or water retention/detention area(s), and comply with all water quality issues set forth by the City of Cedar Falls in the Maintenance and Repair Agreement for the Western Home Communities Ninth Addition.

15. No dwelling or building on any lot in the subdivision shall be occupied until the exterior is completed and finished, the interior is substantially completed and finished, and the City of Cedar Falls, Iowa, issues an occupancy permit. All construction and landscaping shall be completed within 12 months of issuance of building permit by the City of Cedar Falls, Iowa.
16. No old or used buildings shall be moved upon any of the lots in the subdivision for any purpose and all buildings on any lot in the subdivision shall be kept in a reasonable state of repair and upkeep,
17. Inoperable cars, trucks, or other vehicles or equipment shall not be parked or stored on any street or driveway in the subdivision or kept upon any lot unless the same are entirely enclosed in a permanent structure.
18. Commercial and recreational equipment and vehicles of any type, whether camping, boat, utility, trailers of any type, snowmobile, tractors of any type, or otherwise, shall not be parked on driveway in the subdivision or kept upon any residentially zoned lot unless the same be entirely enclosed in a permanent structure, or unless said vehicle as hereinabove described is owned by a guest or invitee of the owner of said lot, in which case, such exception shall not continue for more than thirty (30) days.
19. No bus, semi-tractor, trailer, or truck of any kind, except what is commonly described as a "pickup truck", shall be kept or parked on any residential lot or street in the subdivision, provided, however, that this prohibition shall not apply to such vehicles driven in the subdivision in pursuit of and conducting their usual business.
20. No concrete block, hollow tile construction, modular or pre-built home, earth home, or geodesic dome building is to be erected on any lot in the residentially zoned area.
21. No trees or shrubs shall be planted by any lot owner within the street right-of-way.
22. No radio station or short-wave operators shall construct reception or transmission towers on a lot, nor operate or conduct transmissions from any lot, which shall cause interference to audio or video reception upon any other lot. A satellite dish may be attached to a dwelling on any lot, provided that it shall be attached to the rear of any dwelling and no closer to the side lot lines than such dwelling.
23. No horses, poultry, rabbits or livestock of any variety shall be kept or raised, nor shall any outdoor kennels housing more than two dogs be maintained on any lot in the subdivision.
24. All provisions herein shall be enforceable by appropriate legal proceedings by any present or future owner of the legal or equitable title to any lot in said subdivision. Invalidation of any one or more of the within restrictions by judgment or decree of court shall not be regarded as affecting the validity of any of the other provisions hereof, nor shall any judicial determination with respect to any of the restrictive provisions hereof be regarded as affecting the validity or sufficiency of this instrument as a deed of dedication of said plat.
25. The undersigned and all persons and corporations hereafter acquiring any right, title, or interest in any of the lots in said subdivision shall be taken and held to have agreed and

covenanted with the owners of all other lots in this subdivision and with the respective successors and assigns of all of the rest of such other lots to conform to and observe all of the foregoing covenants, restrictions and stipulations as to the construction of building thereon, for a period of 21 years from the date of filing of said plat, and this Deed of Dedication for record, unless by a vote of a majority of the then owners of the lots, it is agreed to change the said covenants in full or in part. Within the period of 21 years and in accordance with Iowa Code Sections 614.24 and 614.25 or their successor provisions, these covenants, restrictions and stipulations may be extended for an additional 21 years upon compliance with Sections 614.24 and 614.25 of the Code of Iowa. In the event an extension of the covenants, restrictions and stipulations is not filed within the period of 21 years or successive 21-year periods, then the covenants, restrictions and stipulations contained herein shall terminate at the end of the existing period of 21 years.

DEDICATION AND CONSTRUCTION OF STREETS, SEWERS, UTILITIES AND OTHER IMPROVEMENTS

The undersigned agree:

1. That sanitary sewer, together with all necessary manholes and sewer service lines to all lots in the plat will be provided.
2. That utilities, as required by the Subdivision Ordinance of the City of Cedar Falls, Iowa, shall be installed.
3. That City water and municipal fire hydrants will be provided as required by the City of Cedar Falls, Iowa.
4. That the streets described on the attached Plat are hereby dedicated to the City of Cedar Falls, Iowa, and set apart for public use for street purposes.
5. That the recreational trails described on the attached Plat are hereby dedicated to the City of Cedar Falls, Iowa, and set apart for public use for recreational purposes.
6. That permanent easements will be provided for turn-arounds at the end of any streets described on the attached Plat.
7. That off-site easements will be provided for storm sewers and sanitary sewers.
8. That a 4-foot wide portland cement concrete sidewalk, 4 inches thick, and a concrete surface or hard surface entrance and parking area will be installed during or immediately after the construction of a building on any particular lot, and that the sidewalk will be constructed across the full width of the lot and on corner lots; also, across the parking and full length of the lot. The above notwithstanding, sidewalks and recreational trails shall be installed as buildings are constructed on all lots and tracts, or within 5 years from the date of the acceptance of the final plat, whichever comes first.
9. That the work and improvements called for herein shall be in accordance with the construction plans and specifications approved by the City of Cedar Falls, Iowa, and performed under the supervision of the Engineer hired by the owners, with review of such Engineer's certified completion statement by the City Engineer. If the undersigned, its grantees and assigns fail to complete the work and improvements called for herein within one year from the date of the acceptance of said final plat by the City of Cedar Falls, Iowa,

the City may then make the improvements and assess the costs of the same to the respective lots. The owners, for themselves, their successors, grantees and assigns, waive all statutory requirements of notice of time and place of hearing and waive statutory protections and limitations as to cost and assessments and agree that the City may install said improvements and assess the total costs thereof against the lot.

10. That the City may perform the work, levy the cost thereof as assessments, and the undersigned agree that said assessments so levied shall be a lien on the respective lots with the same force and effect as though all legal provisions pertaining to the levy of such special assessments have been observed, and further authorize the City Clerk to certify such assessments to the County Auditor as assessments to be paid in installments as provided by law.

Executed this ____ day of _____ 2019.

WESTERN HOME SERVICES, INC.

By: _____

Name: Kris W. Hansen

Title: Chief Executive Officer

STATE OF IOWA, COUNTY OF BLACK HAWK) ss:

On this ____ day of _____ 2019, before me, a Notary Public in and for the State of Iowa, personally appeared Kris W. Hansen, to me personally known who, being by me duly sworn, did say that she is the Chief Executive Officer of Western Home Services, Inc., the corporation executing the within and foregoing instrument; that no seal has been procured by the corporation; that this instrument was signed on behalf of the corporation by authority of its Board of Directors; and that Kris W. Hansen as Chief Executive Officer acknowledged the execution of this instrument to be the voluntary act and deed of the corporation, by it and by him voluntarily executed.

Notary Public in and for said State

Exhibit "A"

Certificate of Survey – See Attached.

Exhibit “B”

Responsibility for Maintaining the Streets and Features – See Attached.

Exhibit B

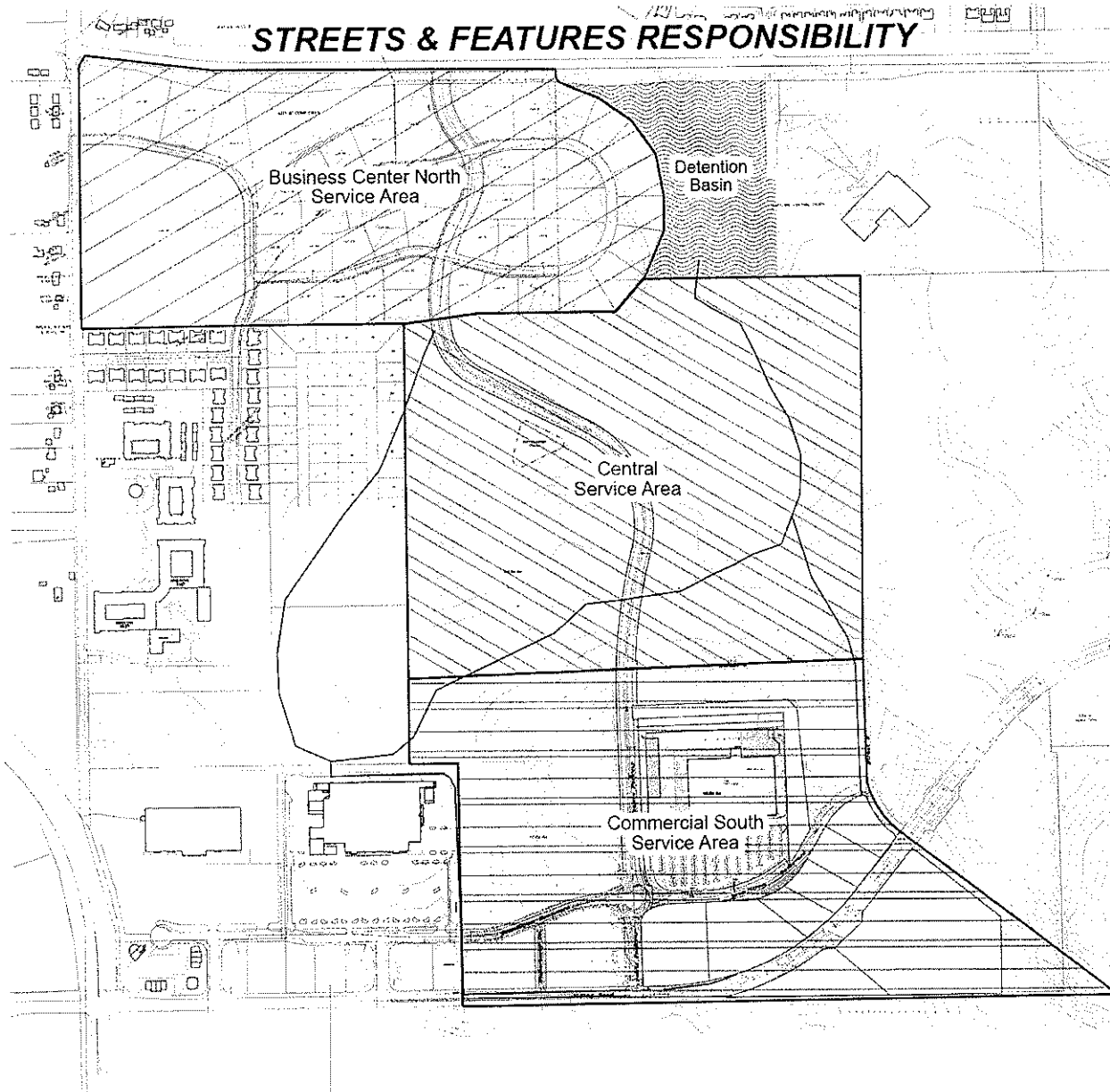

Costs for maintaining boulevard medians, common areas not related to drainage (such as entry features, landscaping, signage), trails, sidewalks, and so on within each service area are allocated to owners within each of the service areas, with one exception: 40% of the cost of maintaining the fountain, entry landscaping and monument sign at Greenhill Road is allocated to the landowners in the Central Service Area with frontage along Prairie Parkway.

Exhibit “C”

Responsibility for Maintaining Drainage and Detention – See Attached.

Exhibit C

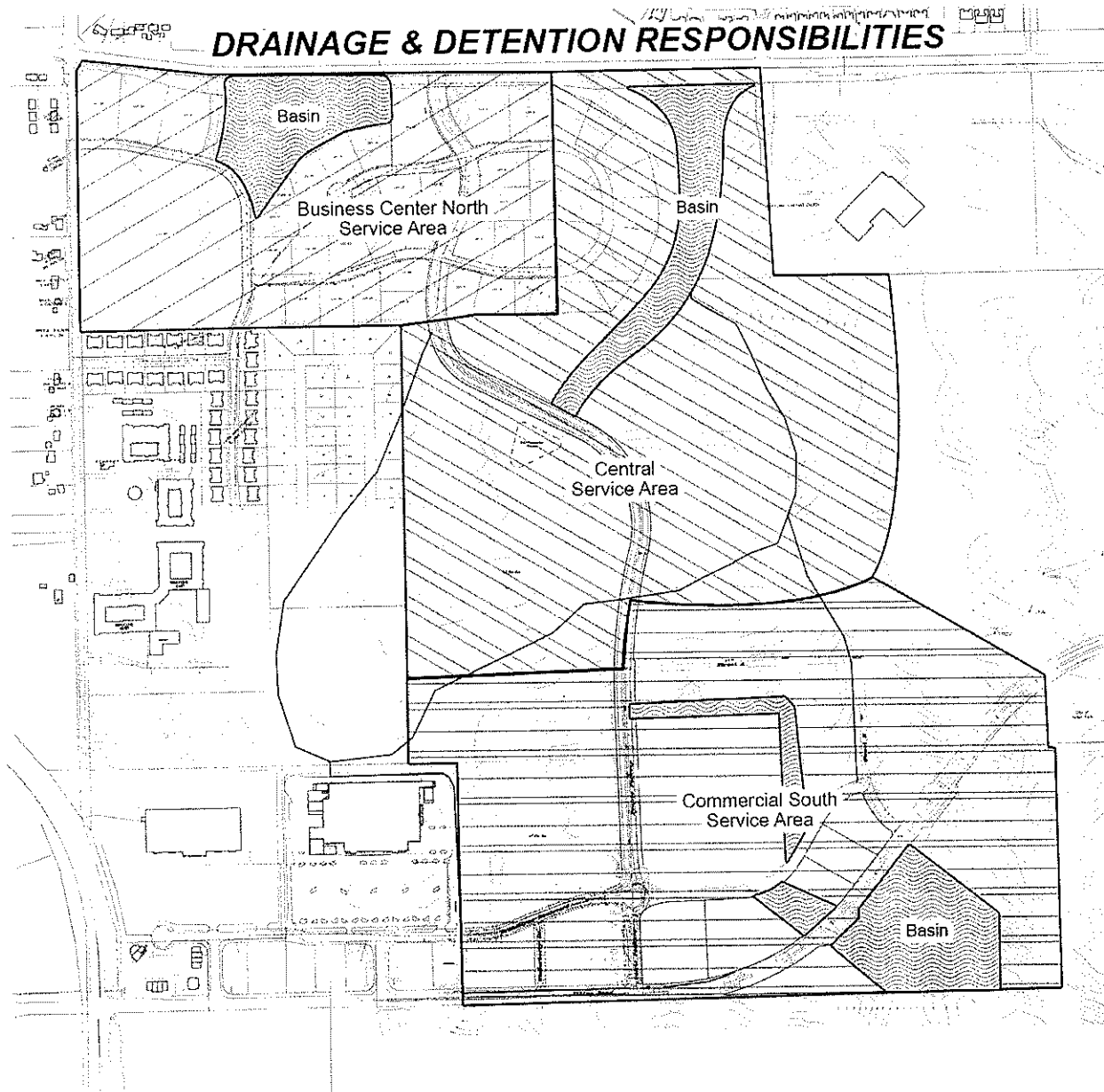

Costs for maintaining drainage ways and detention basins within each service area are allocated to owners within those service areas.



DEPARTMENT OF COMMUNITY DEVELOPMENT

City of Cedar Falls
220 Clay Street
Cedar Falls, Iowa 50613
Phone: 319-273-8600
Fax: 319-273-8610
www.cedarfalls.com

MEMORANDUM

Planning & Community Services Division

TO: Planning & Zoning Commission
FROM: David Sturch, Planner III
DATE: May 1, 2019
SUBJECT: PO-1 Site Plan Review - New Dental Office

REQUEST: PO-1 Site plan review and approval for a new medical office
Case #SP19-008
PETITIONER: Fehr Graham and Levi Architecture
LOCATION: Lot 2 Schofield Stevenson Office Park

PROPOSAL

The petitioner submitted a site plan for a new 4,500 ft² dental office building on Lot 2 of the Schofield Stevenson Office Park in the 1000 block of Hudson Road. The property is located in the PO-1, professional office zoning district that requires site plan and building design review by the Planning and Zoning Commission and City Council.

BACKGROUND

This three (3) acre property was purchased by the City in 1997 with the idea that the site would be used for a future fire station. The city decided to vacate the idea for a fire station and entertained bids to develop this property for private use. The property was sold and rezoned from A-1, agricultural to PO-1, professional office in the spring/summer of 2012. As part of the PO-1 rezoning process, a conceptual development site plan (attached) was submitted and approved by the P&Z Commission and City Council. The site plan included three separate

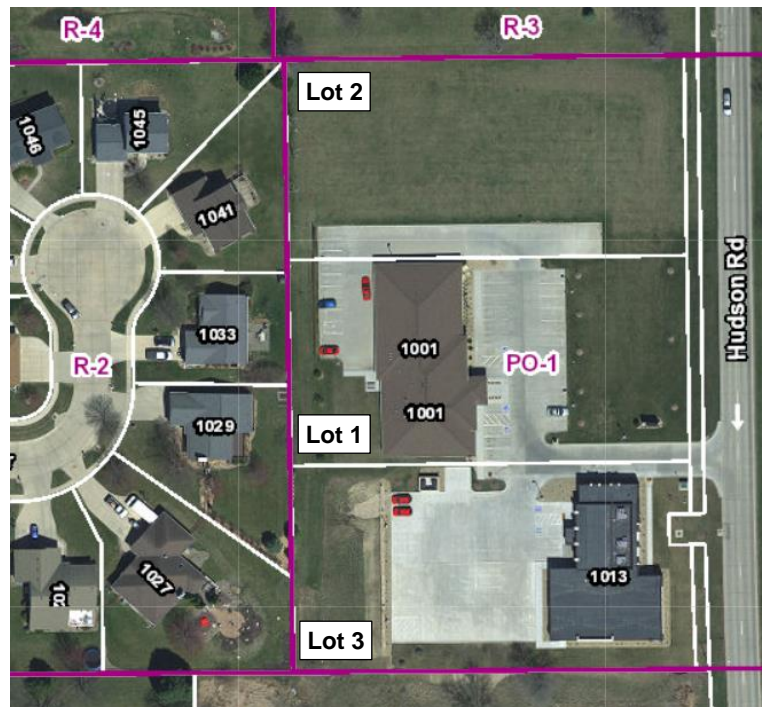

lots for office development. This property was platted as the Schofield Stevenson Office Park and approved in October 2012. Following the plat approval, Dr. Schofield submitted a plan that was approved in August of 2013 for his new chiropractic clinic on Lot 1. A site plan for the southern lot (Lot 3) was reviewed and approved by the Planning and Zoning Commission and City Council in the summer of 2016. This staff report represents the analysis of the northern lot (Lot 2) for Dr. Stevenson's dental office.

The development layout to the right shows the proposed building and paving on the north lot. The dental office is located in the middle of the lot with parking in front and behind the building. A new driveway curb cut will provide a secondary access for all three lots onto Hudson Road. Also, a parking lot and aisle between the north lot and the south lot with additional parking is included with this development, which was part of the original plan.

The original concept plan only showed one driveway location onto Hudson Road. Also, the Deed of Dedication of the The Schofield Stevenson Office Park subdivision identified one access location into this development. City staff reviewed this request for a second driveway onto Hudson Road and offers the following observations:

1. The second driveway will provide better access to the site for emergency vehicles.
2. In case of an emergency on the southern lot, the single driveway may be blocked for vehicles to enter/exit the site.
3. The current driveway is congested at times.
4. The proposed secondary driveway provides ample spacing from the current driveway and other nearby street intersections.
5. Both driveways will be a right in and right out access with no median cut on Hudson Road.
6. The Schofield Stevenson Office Park Deed of Dedication must be amended and signed by all the owners in the development.

The items listed above provide a supporting case for a second driveway onto Hudson Road. Also, the three property owners signed an amended Deed of Dedication for said secondary access. Staff recommends approval of the second access onto Hudson Road from Lot 2 of the Schofield Stevenson Officer Park plat. Finally, the parking lot and aisle between the north and south lot will provide additional circulation and parking for the entire development.

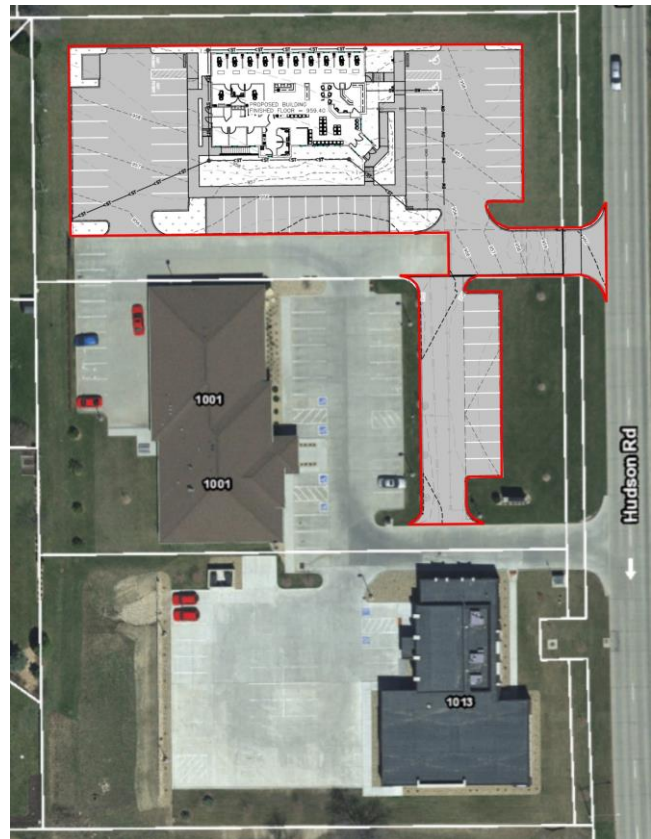

ANALYSIS

This property is located in the PO-1, Professional Office District which is intended to provide for the establishment of planned business, office and medical buildings or facilities. A detailed site plan review is required to ensure that the development site satisfies a number of standards. Details such as building design and location, parking, landscaping, open space, signage, dumpster location, pedestrian access and other similar criteria are reviewed to ensure orderly and quality development in the Professional Office District.

Following is a review of the zoning ordinance requirements:

- 1) Use: This site plan proposes a 4,558 ft² dental office in the PO-1, Professional Office District. This use is permitted in the PO-1 District and is compatible with the existing and proposed use in the subdivision. **Use is allowed under the zoning district and the existing land use plan.**
- 2) Building Location: This district includes a 20-foot setback around the development site. The 20-foot setback is for buildings and parking lots. The following table summarizes the building and parking lot setbacks.

| Yard Area | Required Setbacks | Building Setback | Parking Lot Setback |
|--------------|-------------------|------------------|---------------------|
| East (front) | 20' | 102' | 20' |
| North (side) | 20' | 20' | 20' |
| West (back) | 20' | 97' | 20' |
| South (side) | 0' | 64' | 25' |

There are no setbacks along the interior lot line. **Building and parking lot setbacks are satisfied.**

- 3) Parking: The parking requirement for a dental office is five parking stalls plus one stall for every 200 square feet of gross floor area over 1,000 square feet. The proposed building is 4,558 ft² in area requiring a minimum of 23 parking stalls. The proposed site plan offers 46 total parking stalls including 2 handicap accessible spaces. The proposed clinic will have multiple dentists working at the same time. With the clients being served and waiting, along with the staff, the 43 parking stalls are more realistic for this development. **Parking requirements are satisfied.**
- 4) Open Green Space/Landscaping: The PO-1, Professional Office District requires a minimum required landscape area of not less than 10% of the total development site, excluding the perimeter setback area. Again, the setback area is intended for open space and landscaping. The development site is just under one acre or 41,770 ft². The perimeter setback area equals 10,764 ft². The open space is calculated by deducting the lot area from the perimeter setback or 31,006 ft² (41,770 - 10,764 = 31,006). 10% of 31,006 equals 3,100 ft² of open space. Excluding the perimeter setback, the property has 4,340 ft² of open space. **Open space satisfied.**

The landscaping provision has three different components that include development site plantings, parking lot trees, and street trees. The development site standards require 0.02 points per square foot of lot area. These plantings must be distributed throughout the site and parking lot instead of being confined to one area. The parking lot plantings require one overstory tree for every 15 parking stalls. Finally, street trees must be planted at the rate of 0.75 points per linear foot of street frontage. The following table summarizes the landscaping points for this site.

| Landscaping | | |
|------------------|-----------------|-----------------|
| Type | Required (pts.) | Provided (pts.) |
| Development site | 836 | 885 |
| Street Trees | 108 | 160 |
| Parking trees | 4 | 4 |

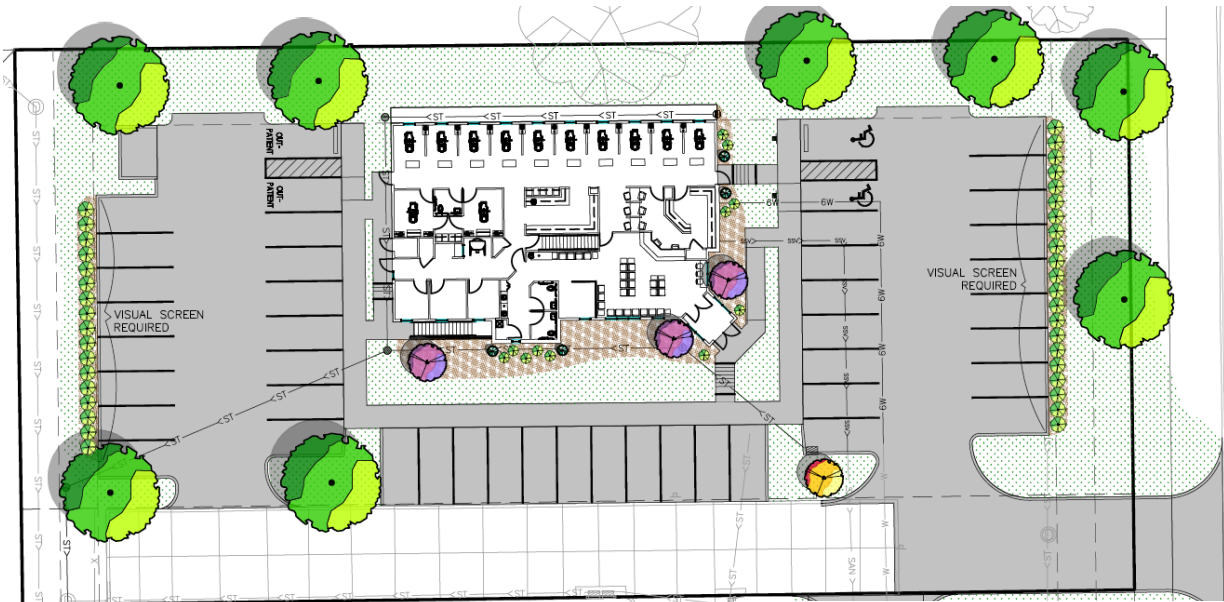

The landscape plan depicts a number of bushes and shrubs around the building and along the front and back of the parking lot. These parking lot plantings serve and a visual screen from Hudson Road and the adjacent residential properties.

Landscaping plan satisfied.

A new parking lot aisle and stalls will be installed through the middle of the development. There are existing trees across the front of the existing parking lot. These five trees will be replaced or relocated as part of the construction of the new parking lot aisle and stalls. Staff recommends moving two of these trees to the front of the new parking lot and alternate the spacing with the existing street trees.

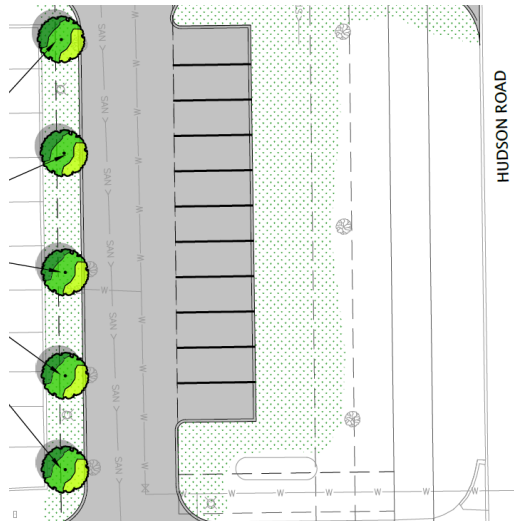

- 5) **Building Design:** The PO-1 District requires a design review of various elements to ensure compatibility with surrounding buildings and compliance with building standards. The review items are noted below with a brief narrative of each item.



- a) **Proportion:** *The relationship between the width and height of the front elevations of adjacent buildings shall be considered in the construction or alteration of a building; the relationship of width to height of windows and doors of adjacent buildings shall be considered in the construction or alteration of a building.*

The plan for the Schofield Stevenson Office Park includes three office buildings dedicated to a chiropractor, dentist and orthodontist. The existing Schofield Chiropractor is located on Lot 1 (middle lot) and the Holahan and Boe Orthodontist is on Lot 3 (south lot). The remaining lot is reserved for a future dental office for Dr. Stevenson. These buildings are single story structures of similar size. The design of the proposed All Smiles Dental Clinic building includes an assortment of windows and transoms on the front and side of the building. The entry includes full length windows on three sides of the vestibule. These features are found on the existing chiropractic and orthodontic buildings in the development.

- b) **Roof shape, pitch, and direction:** *The similarity or compatibility of the shape, pitch, and direction of roofs in the immediate area shall be considered in the construction or alteration of a building.*

The proposed dental office building has a hip roof with off-set peaks and valleys that is similar to the chiropractic building on Lot 1. The proposed roof is topped with asphalt shingles. The southernmost building is constructed with a flat roof that has alternating wall treatments extending above the roof line which enhances the development.

- c) **Pattern:** *Alternating solids and openings (wall to windows and doors) in the front facade and sides and rear of a building create a rhythm observable to viewers. This pattern of solids and openings shall be considered in the construction or alteration of a building.*

Overall the design of the dental office includes a series of materials and textures along with the window placement on all sides of the building. Vertical glass panels extend

from the ground to the top of the entry. Window treatments along the front and south side of the building include transoms and sun shades. Other elements including extended facades and corner features are utilized with an assortment of materials that complement the design of the existing buildings in the development.

- d) **Materials and texture:** *The similarity or compatibility of existing materials and textures on the exterior walls and roofs of buildings in the immediate area shall be considered in the construction or alteration of a building. A building or alteration shall be considered compatible if the materials and texture used are appropriate in the context of other buildings in the immediate area.*

The general design of the building includes a combination of brick, cultured stone, metal, composite vertical siding, composite board/batten panels and aluminum clad casement windows. The cultured stone treatment is found on all sides of the building. The stone extends halfway up the facade on the front and south side of the building and ¼ of the back facade. Brick materials are introduced on these two facade designs separated by a precast sill band. The upper portions of the front, south and back include a composite vertical siding and the north side is covered with a composite board and batten panel. The proposed building has similar materials and patterns as the chiropractic building on Lot 1.

- e) **Color:** *The similarity or compatibility of existing colors of exterior walls and roofs of buildings in the area shall be considered in the construction or alteration of a building.*

The proposed building provides a good color contrast with an assortment of materials including dark gray brick, white/gray stone materials, light gray vertical siding and dark gray composite board and batten panels. Other color combinations of the neighboring buildings include dark brown, tan and reddish brown accents on the chiropractic building and darker grays on the orthodontic building.

- f) **Architectural features:** *Architectural features, including but not limited to, cornices, entablatures, doors, windows, shutters, and fanlights, prevailing in the immediate area, shall be considered in the construction or alteration of a building. It is not intended that the details of existing buildings be duplicated precisely, but those features should be regarded as suggestive of the extent, nature, and scale of details that would be appropriate on new buildings or alterations.*

The design provides an attractive building for the proposed dental office and is compatible with the existing building in the development. The use of metal sunscreens and stone columns to delineate the front entry along with brick, glass and wood composite panels replicates the exterior finish materials that are placed proportionately on the building and used on the neighboring buildings. **Overall, the design of the building fits the intent of this PO-1 District.**

- 6) **Trash Dumpster Site:** The site plan shows a dumpster near the northwest corner of the parking lot. The dumpster enclosure includes a 8'-0" brick wall with a metal gate. These materials on the enclosure will match the color of the materials on the building. **Garbage enclosure plan satisfied.**

- 7) Signage: The signage for this building is included on the existing freestanding monument sign at the south entrance to this site. This monument sign will be utilized for the three lots in this development. No additional freestanding signs are permitted in this development. Wall signs are noted on the elevation drawings off the front and south side of the building. Wall signs shall not exceed 10% of the surface area of the wall and no more than two wall surfaces may be used for signage. **Signage requirements are generally met and will be reviewed in detail at time of sign permit issuance.**
- 8) Storm water management: A storm water detention area located at the southwest corner of the three lot development. The storm water around the building and parking lots will be captured in the existing catch basins and transferred through existing storm sewers to the aforementioned detention basin. **A Storm water management and routing plan was submitted by the applicant that demonstrates an acceptable management plan that satisfies the storm water requirements.**
- 9) Pedestrian Access: The original development plan included the installation of a recreational trail/sidewalk across all three lots of this development. The City is planning a 5-foot wide sidewalk along the west side of Hudson Road from W. 8th Street to W. 12th Street in the summer of 2019. The petitioner's engineer evaluated a sidewalk connection to the main entry of the building. Due to the topography of the site and design of the parking lots to match the existing driveway, a sidewalk from the building to the public sidewalk along Hudson Road is not feasible to due slope and grade to the public right of way. There is a pedestrian access along the south driveway and users can access this sidewalk once the Hudson Road sidewalk is installed this summer. **Pedestrian plan satisfied.**
- 10) Easements: Additional easements between Lots 1 and 2 are necessary to provide access through each property and utility services.
 - 1) The existing driveway along the south side of Lot 2 provides access to the parking area behind the building on Lot 1. A cross access easement has been provided and signed by both property owners.
 - 2) Water and sanitary services will cross Lot 1 and connect into the proposed building on Lot 2. An easement agreement has been provided and signed by both property owners.

TECHNICAL COMMENTS:

All basic utility services are available to the property from Hudson Road. The property owner/contractor is responsible to extend all utility services to the building. These utility extensions will be reviewed by CFU personnel as part of the building plan review.

The property owner of the middle lot grants access to the owner of the north lot for driveway, parking, water and sanitary service. The owner of the north lot granted access to the owner of the middle lot for parking behind the building. Civil plans for the proposed dental office building and parking lot have been submitted to review the storm water flow to the adjacent detention basin.

The site plan review fee has been submitted.

STAFF RECOMMENDATION

The Community Development Department recommends approval of the dental office building on Lot 2 of the Schofield Stevenson Office Park subject to the following conditions:

- 1) Conformance with the technical comments identified in the staff report.
- 2) Record ingress/egress easement for revised driveway plan.
- 3) Additional comments provided by the Planning and Zoning Commission.

PLANNING & ZONING COMMISSION

Discussion/Vote

5/8/2019

Attachments: Location Map
 Original Site Plan
 Site Plan
 Architectural Renderings
 Landscaping Plan
 Dumpster Enclosure Plan

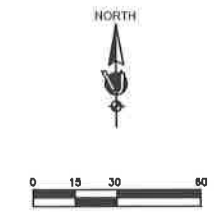
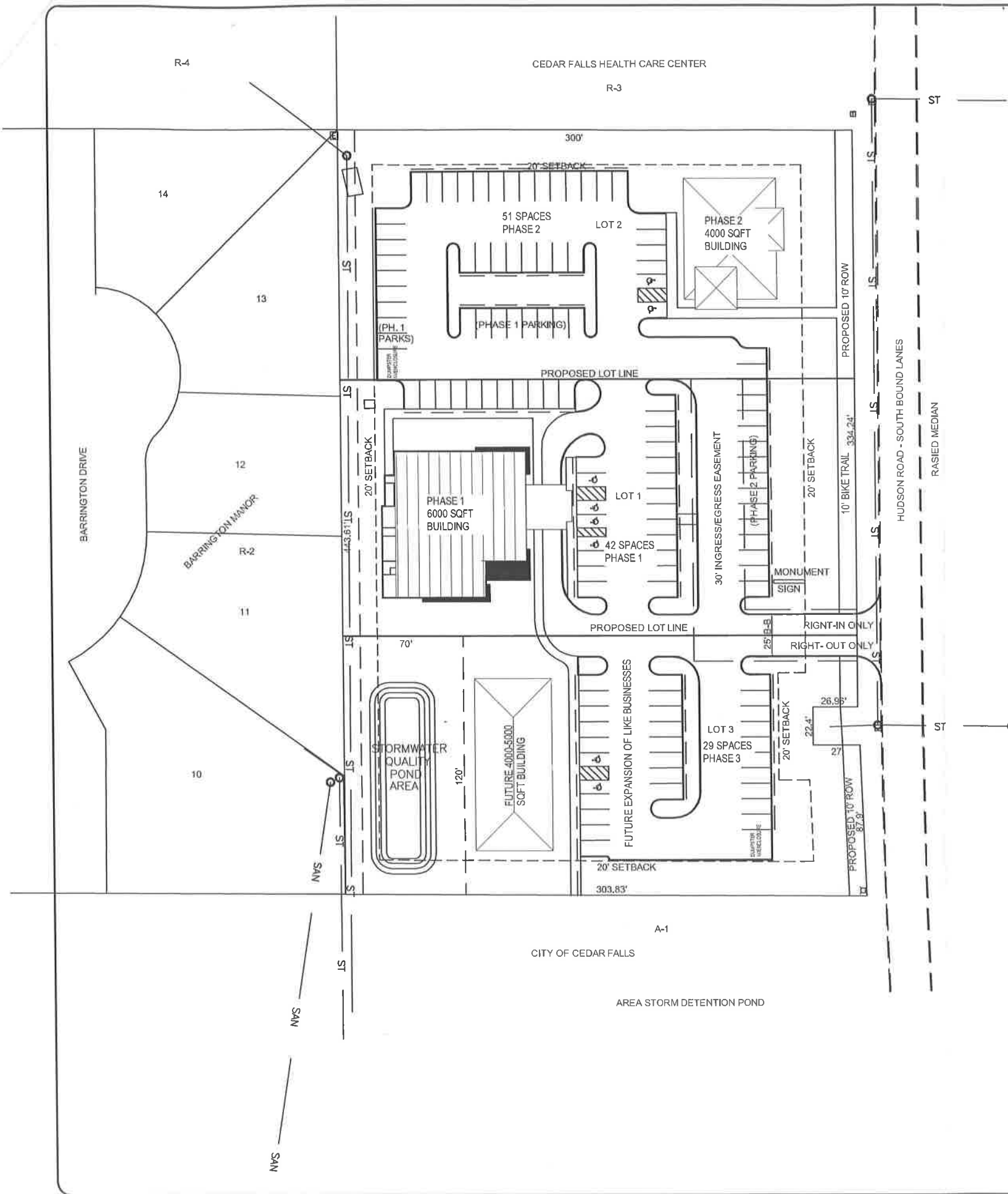

DEVELOPMENT NOTES

EXISTING ZONING: A-1, AGRICULTURAL
PROPOSED ZONING: PO-1, PROFESSIONAL OFFICE DISTRICT
PROJECT AREA = 3.05 AC.
PROPERTY WILL BE PLATTED INTO THREE LOTS
PARKING LOT/DRIVES WILL HAVE INGRESS AND EGRESS USE EASEMENT
COMMON STORMWATER QUALITY AREA IN SOUTHWEST CORNER
ONE COMMON DRIVE FROM HUDSON ROAD WITH RIGHT-IN AND RIGHT-OUT ONLY
CONSTRUCTION PHASING:
PHASE 1 = LOT 1 IMPROVEMENTS AND ADJACENT RECREATION TRAIL, EXCEPT AS NOTED.
PHASE 2 = LOT 2 IMPROVEMENTS AND ADJACENT RECREATION TRAIL, EXCEPT AS NOTED.
PHASE 3 = LOT 3 IMPROVEMENTS AND ADJACENT RECREATION TRAIL
OWNER: SCHOFIELD-STEVENSON, L.L.C.
CEDAR FALLS, IOWA

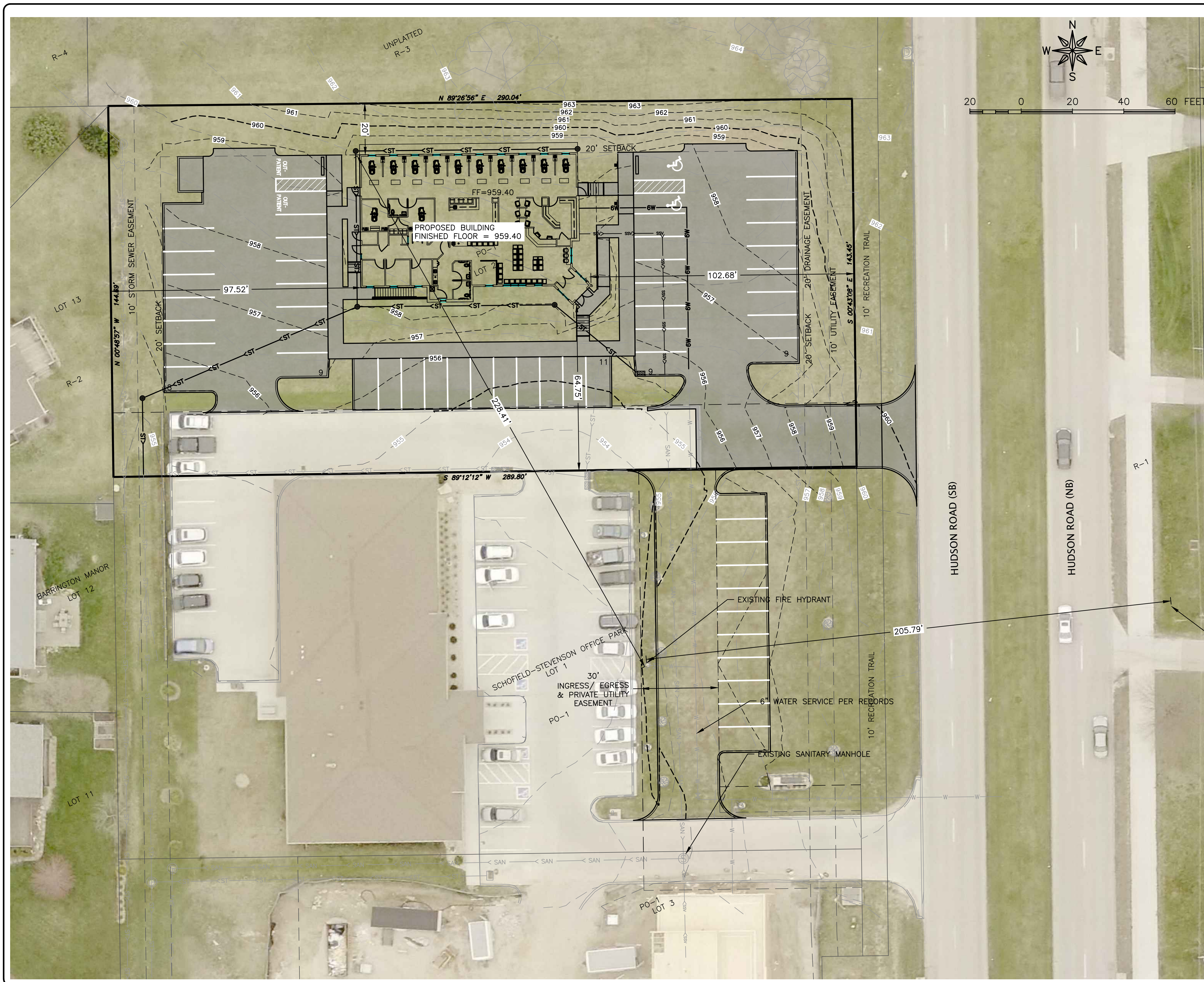

SITE DEVELOPMENT PLAN ALL-SMILES DENTAL CLINIC

SITE ADDRESS: #### HUDSON ROAD, CEDAR FALLS, IA 50613
 LEGAL DESCRIPTION: SCHOFIELD-STEVENSON OFFICE PARK, LOT 2
 OWNER
 ASFD, LLC.
 1421 W 1ST STREET, SUITE B
 CEDAR FALLS, IA 50613
 OWNER REPRESENTATIVE / GENERAL CONTRACTOR
 JASON HUFF
 HUFF CONTRACTING
 1310 GRANDVIEW AVENUE
 WATERLOO, IA 50703
 ARCHITECT
 LEVI ARCHITECTURE
 1009 TECHNOLOGY PARKWAY
 CEDAR FALLS, IA 50613
 ZONING: PO-1
 LOT INFORMATION
 LOT SIZE: 41,770 S.F. / 0.96 ACRE
 SETBACK REQUIREMENTS
 FRONT: 20'
 REAR: 20'
 SIDE: 20'
 BUILDING AND LOT USE
 PROPOSED (TOTAL LOT)
 BUILDING FOOTPRINT: 4,558 S.F. (10.9%)
 TOTAL PAVEMENT & SIDEWALKS: 23,053 S.F. (55.2%)
 TOTAL VEGETATED SURFACE: 27,611 S.F. (33.9%)
 PROPOSED (EXCLUDES SETBACK)
 LOT AREA LESS SETBACK: 31,006 S.F.
 BUILDING FOOTPRINT: 4,558 S.F. (14.7%)
 TOTAL PAVEMENT & SIDEWALKS: 22,108 S.F. (71.3%)
 TOTAL VEGETATED SURFACE: 4,340 S.F. (14.0%)
 EXISTING
 BUILDING FOOTPRINT: N/A
 TOTAL PAVEMENT & SIDEWALKS: 5,098 S.F. (12.2%)
 TOTAL VEGETATED SURFACE: 36,672 S.F. (87.8%)
 PARKING DATA (PROPOSED)
 TOTAL REQUIRED PARKING:
 MEDICAL OR DENTAL CLINICS: FIVE PARKING SPACES,
 PLUS ONE ADDITIONAL PARKING SPACE FOR
 EACH 200 SQUARE FEET OF GROSS FLOOR
 AREA OVER 1,000 SQUARE FEET.
 6796 SF FLOOR SPACE = 34 STALLS
 TOTAL PROVIDED PARKING: 46 PARKING STALLS
 FLOOD PLAIN - N/A

BM1

| DATUM INFORMATION | |
|----------------------------|---------------------------------|
| VERTICAL CONTROL: | NAVD88 |
| HORIZONTAL CONTROL: | NAD83 IOWA STATE PLANE NORTH |
| BENCHMARK INFORMATION | |
| BM1 = BM DESCRIPTION (CPx) | N-xxx.xx, E-xxx.xx, ELEV-xxx.xx |
| BM2 = BM DESCRIPTION (CPx) | N-xxx.xx, E-xxx.xx, ELEV-xxx.xx |

FEHR GRAHAM
ENGINEERING & ENVIRONMENTAL

ILLINOIS
IOWA
WISCONSIN

OWNER/DEVELOPER:
ASFD, LLC.
1421 W 1ST STREET, SUITE B
CEDAR FALLS, IA 50613

PROJECT AND LOCATION:
ALL-SMILES DENTAL CLINIC
CEDAR FALLS, IOWA

DRAWN BY: AJB
APPROVED BY: NPK
DATE: 4/22/2019
SCALE: AS NOTED

| REVISIONS | | |
|-----------|-------------|------|
| REV. NO. | DESCRIPTION | DATE |
| | | |
| | | |
| | | |

DRAWING:
SITE DEVELOPMENT PLAN
SET TYPE: SUBMITTAL3

JOB NUMBER:
18-665
SHEET NUMBER:
C0.3

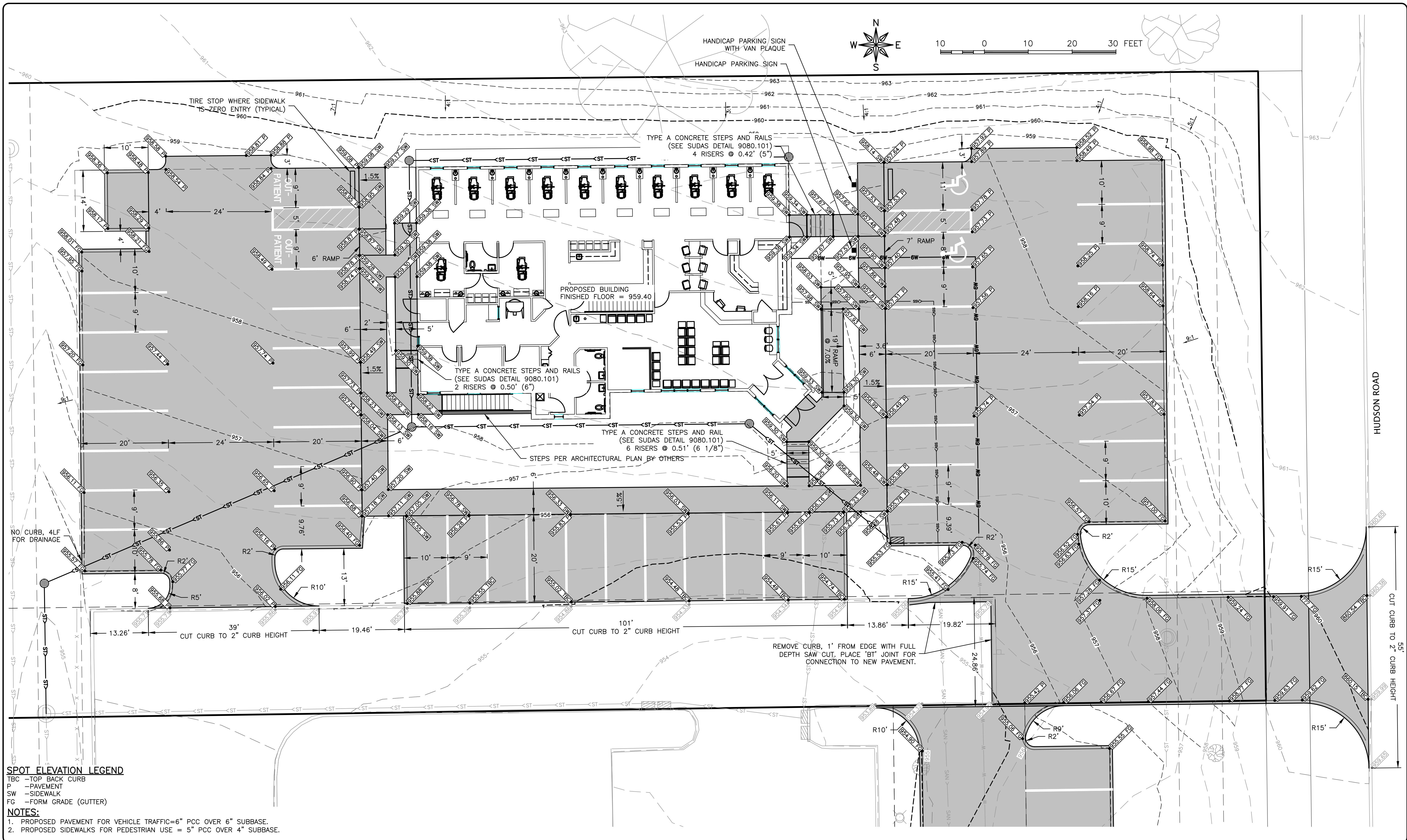

SPOT ELEVATION LEGEND

- TBC -TOP BACK CURB
- P -PAVEMENT
- SW -SIDEWALK
- FG -FORM GRADE (GUTTER)

NOTES:

1. PROPOSED PAVEMENT FOR VEHICLE TRAFFIC=6" PCC OVER 6" SUBBASE.
2. PROPOSED SIDEWALKS FOR PEDESTRIAN USE = 5" PCC OVER 4" SUBBASE.

FEHR GRAHAM
ENGINEERING & ENVIRONMENTAL

ILLINOIS
IOWA
WISCONSIN

OWNER/DEVELOPER:
ASFD, LLC.
1421 W 1ST STREET, SUITE B
CEDAR FALLS, IA 50613

PROJECT AND LOCATION:
ALL-SMILES DENTAL CLINIC
CEDAR FALLS, IOWA

DRAWN BY: AJB
APPROVED BY: NPK
DATE: 4/22/2019
SCALE: AS NOTED

| REVISIONS | | |
|-----------|-------------|------|
| REV. NO. | DESCRIPTION | DATE |
| | | |
| | | |
| | | |

DRAWING:
PAVING PLAN - LOT 2

SET TYPE: SUBMITTAL3

JOB NUMBER:
18-665

SHEET NUMBER:
C2.1

New Medical Office

Hudson Road | Cedar Falls

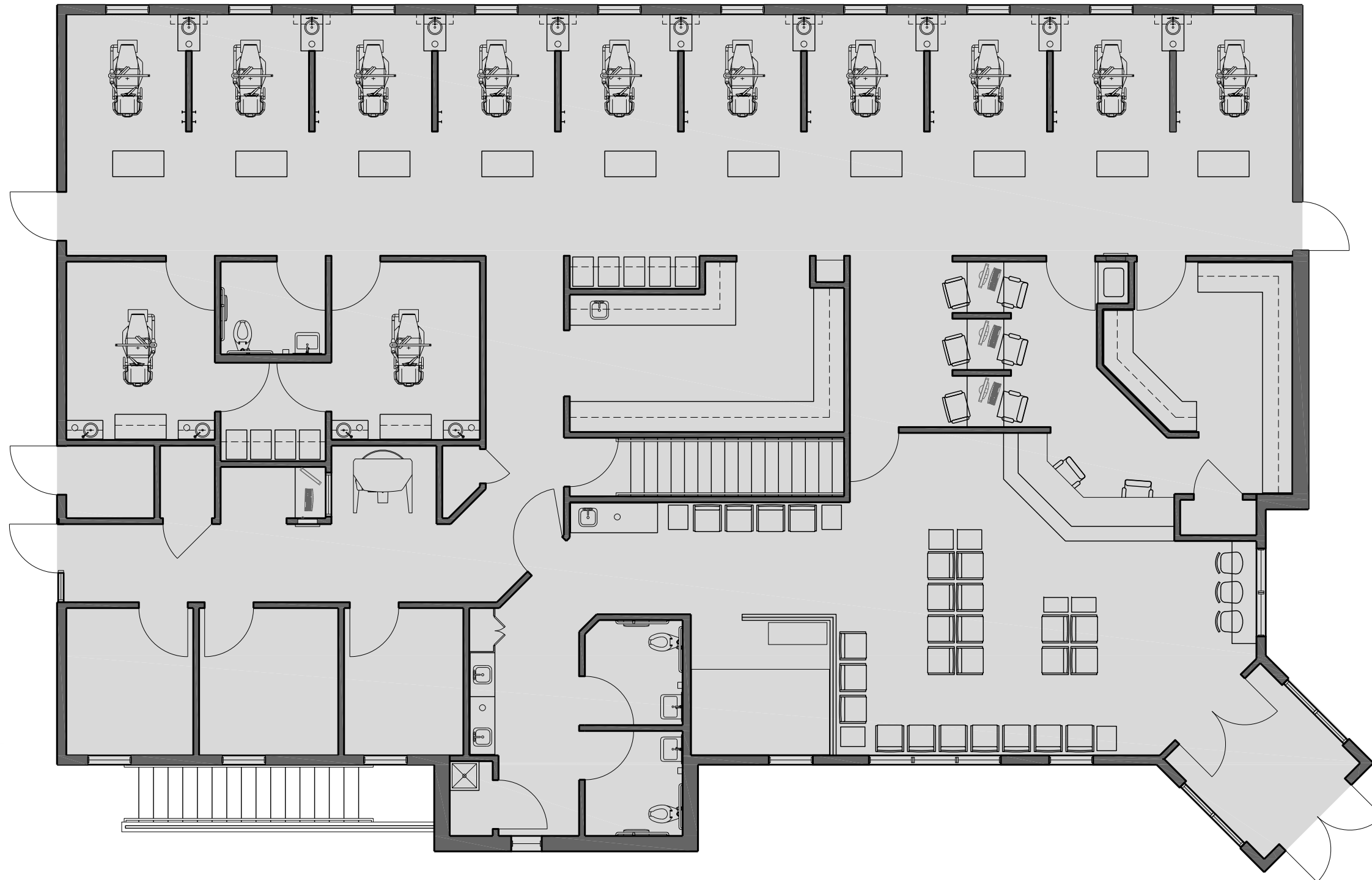

New Medical Office

Hudson Road | Cedar Falls

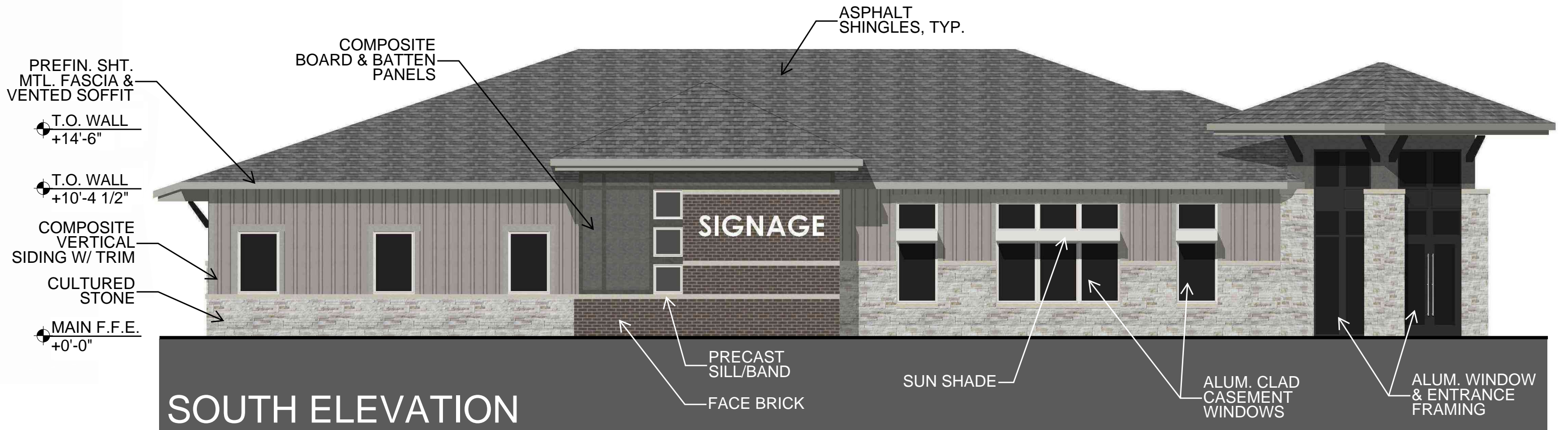

New Medical Office

Hudson Road | Cedar Falls

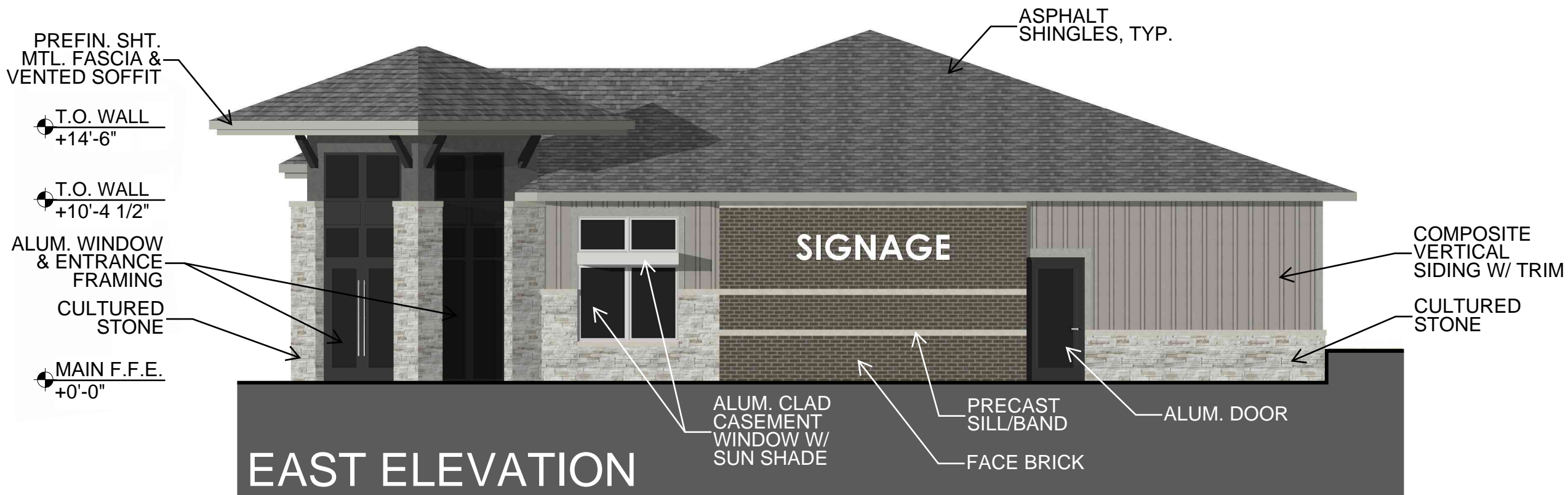

New Medical Office

Hudson Road | Cedar Falls

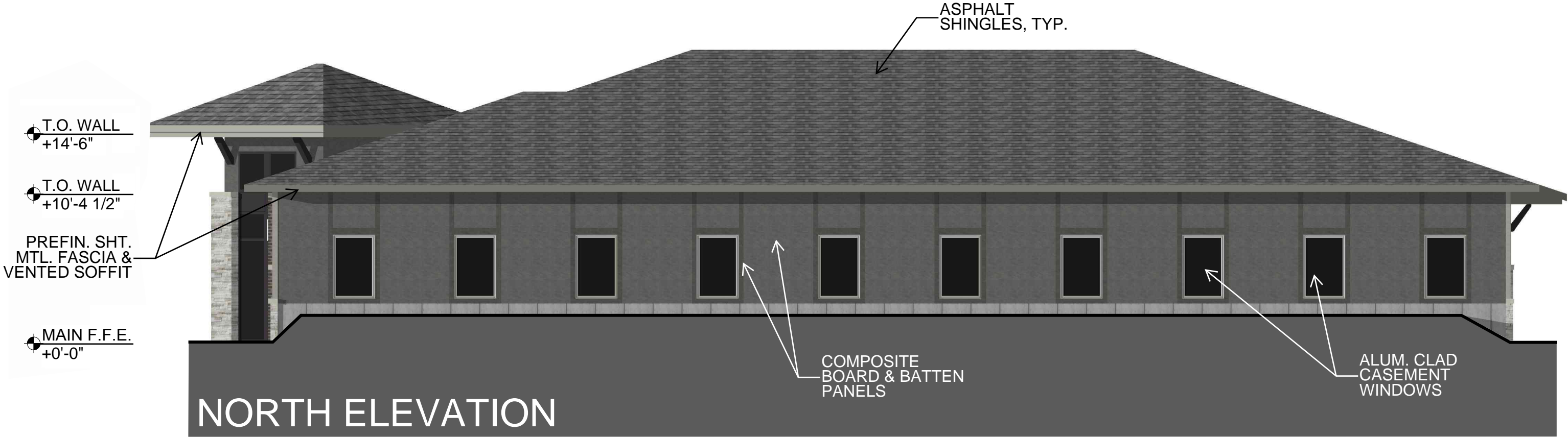

New Medical Office

Hudson Road | Cedar Falls



New Medical Office

Hudson Road | Cedar Falls



New Medical Office

Hudson Road | Cedar Falls



New Medical Office

Hudson Road | Cedar Falls

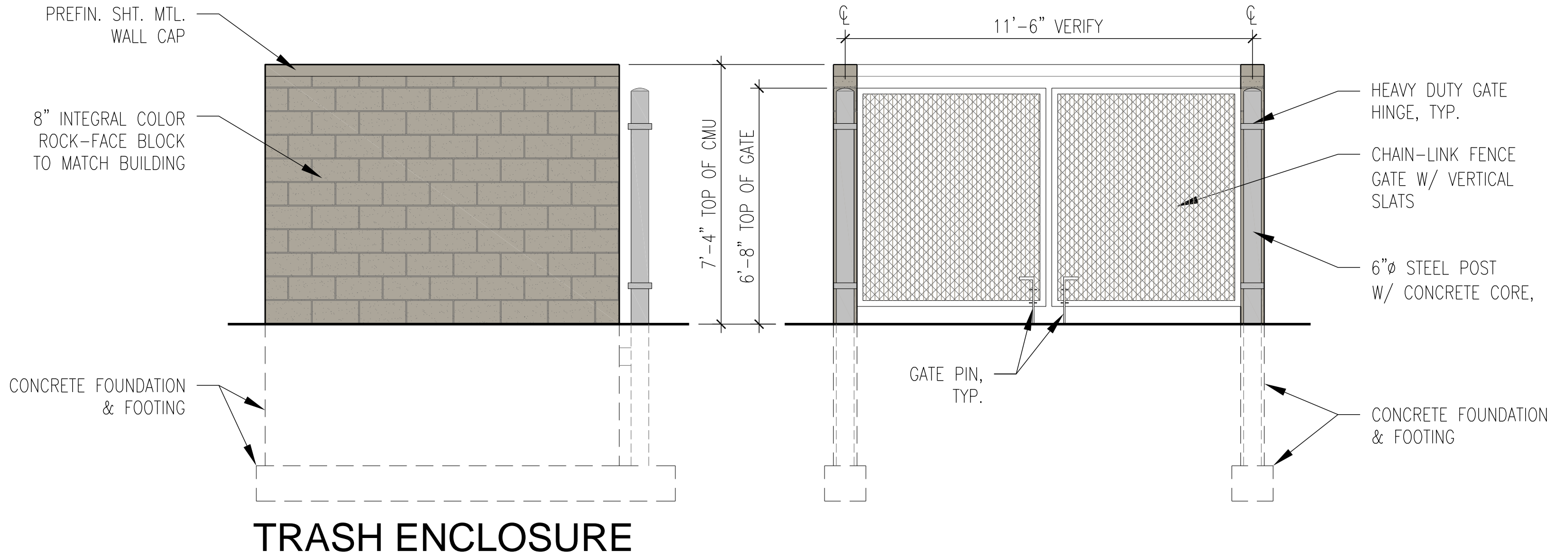

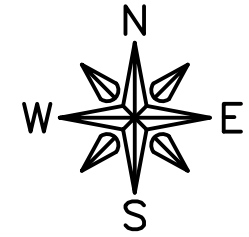

20 0 20 40 60 FEET

LANDSCAPE PLAN ALL-SMILES DENTAL CLINIC

ZONING: PO-1 – PROFESSIONAL OFFICE DISTRICT

REQUIREMENTS PER ZONING ORDINANCE FOR PO-1 – PROFESSIONAL OFFICE DISTRICT:

- 1 10% OF DEVELOPMENT SITE EXCLUSIVE OF PERIMETER SETBACK
SITE AREA LESS SETBACK = 31,006 SF
• 31,006 SF * .10 = 3,101 SF LANDSCAPE AREA
- 2 0.02 PTS/SF OF SITE
• 41,770 SF * 0.02 PTS/SF = 836 PTS
- 3 STREET TREES, MINIMUM OF .75 PTS/LF OF FRONTAGE
• 143 LF * 0.75 PTS/LF = 108 PTS
- 4 PLANTINGS WITHIN PARKING AREAS, RECOMMEND 1 OVERSTORY TREE/15 STALLS
• 48 STALLS/15 = 4 TREES

COMPLIANCE AS SHOWN ON PLAN

- 1 LANDSCAPE AREA CALCULATION (EXCLUDES ALL SETBACK AREA)
LOT AREA LESS SETBACK: 31,006 S.F.
BUILDING FOOTPRINT: 4,558 S.F. (14.7%)
TOTAL PAVEMENT & SIDEWALKS: 22,108 S.F. (71.3%)
TOTAL VEGETATED SURFACE: 4,340 S.F. (14.0%)
- 2 SITE PLANTINGS (EXCLUDES STREET TREES AND PARKING LOT TREES)
OVER STORY TREES
4 EACH, 2" CAL @ 80 PTS EACH = 320 PTS
UNDER STORY TREES
3 EACH, 1.5" CAL @ 30 PTS EACH = 90 PTS
CONIFERS
0 EACH, #' TALL @ 0 PTS EACH = 0 PTS
SHRUBS
42 EACH, 5 GAL @ 10 PTS EACH = 420 PTS
11 EACH, 2 GAL @ 5 PTS EACH = 55 PTS
TOTAL SITE PLANTING POINTS SHOWN = 885
- 3 STREET TREES
OVER STORY TREES
2 EACH, 2" CAL @ 80 PTS EACH = 160 PTS
- 4 PARKING LOT TREES
4 OVER STORY TREES PROVIDED

ALL COUNTS PROVIDED EXCLUDE TREE RELOCATION/REPLACEMENT SHOWN ON LOT 1

LANDSCAPE LEGEND

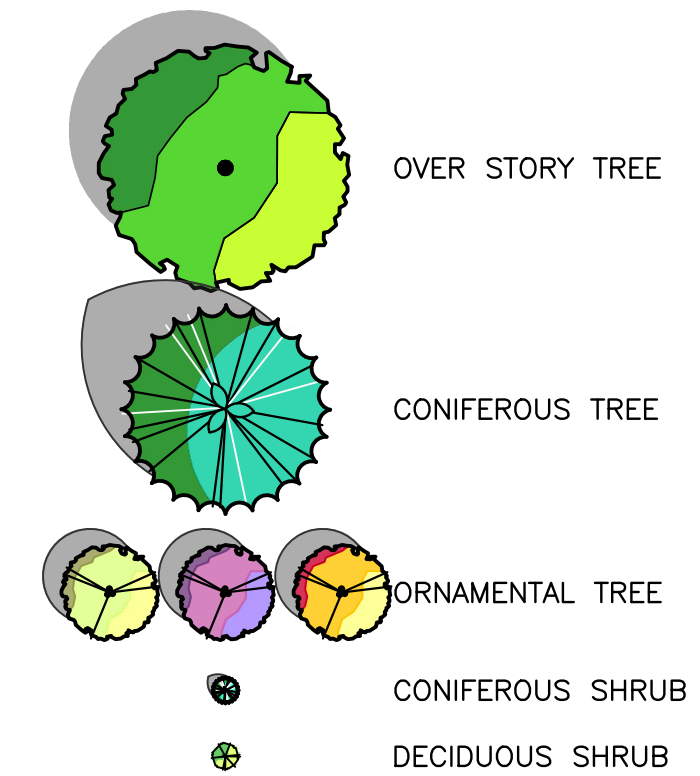

TYPE 1 SEED MIX (LAWN)
SUDAS 9010.06

MULCHED LANDSCAPE AREA
COLOR & TYPE PER OWNER

NOTES:

1. FINAL LANDSCAPE PLAN TO BE PROVIDED BY PROJECT LANDSCAPER
2. VISUAL SCREEN SHALL CONSIST OF A CONTINUOUS ROW OF SHRUBS OR OTHER SIMILAR PLANTINGS OF AT LEAST 3 FEET IN HEIGHT AT THE TIME OF PLANTING



HUDSON ROAD

FEHR GRAHAM
ENGINEERING & ENVIRONMENTAL

ILLINOIS
IOWA
WISCONSIN

OWNER/DEVELOPER:

ASFD, LLC.
1421 W 1ST STREET, SUITE B
CEDAR FALLS, IA 50613

PROJECT AND LOCATION:

ALL-SMILES DENTAL
CLINIC
CEDAR FALLS, IOWA

DRAWN BY: AJB
APPROVED BY: NPK
DATE: 4/22/2019
SCALE: AS NOTED

| REVISIONS | | |
|-----------|-------------|------|
| REV. NO. | DESCRIPTION | DATE |
| | | |
| | | |
| | | |

DRAWING:

LANDSCAPE PLAN

SET TYPE: SUBMITTAL3

G:\C3D\18-665 All Smiles Dental Office\18-665 Design.dwg, C4.1

JOB NUMBER:

18-665

SHEET NUMBER:

C4.1



DEPARTMENT OF COMMUNITY DEVELOPMENT

City of Cedar Falls
220 Clay Street
Cedar Falls, Iowa 50613
Phone: 319-273-8606
Fax: 319-273-8610
www.cedarfalls.com

MEMORANDUM

Planning & Community Services Division

TO: Planning & Zoning Commission
FROM: Iris Lehmann, Planner II
DATE: May 2, 2019
SUBJECT: Site Plan - 5601 University Avenue

REQUEST: Site Plan Review – MPC, Major Thoroughfare Planned Commercial District.
Project #: SP19-010

PETITIONER: Lori and Kyle Larson, Owner

LOCATION: 5601 University Avenue

PROPOSAL

The new owners of 5601 University Avenue are proposing to build a 24' x 36' detached storage shed in the property's rear yard and modify the existing parking lot layout to accommodate a driveway to a proposed storage shed. The proposed modifications would serve the new business that is moving into 5601 University Avenue, Design Lab.

BACKGROUND

In February 2016 the single family home at 5601 University Avenue was rezoned to MPC, Major Thoroughfare Planned Commercial District in order for it to be converted to and operate as a beauty parlor. At this time, the property is one of five within this MPC district, see image to the right.

The MPC district encourages a mixture of residential, institutional, professional office and commercial oriented land uses. It further seeks to do so in a manner that will result in minimal negative impacts upon adjacent low density residential zoning districts or residential uses. As such, per City Code Sec. 26-182 (e), any significant changes to a

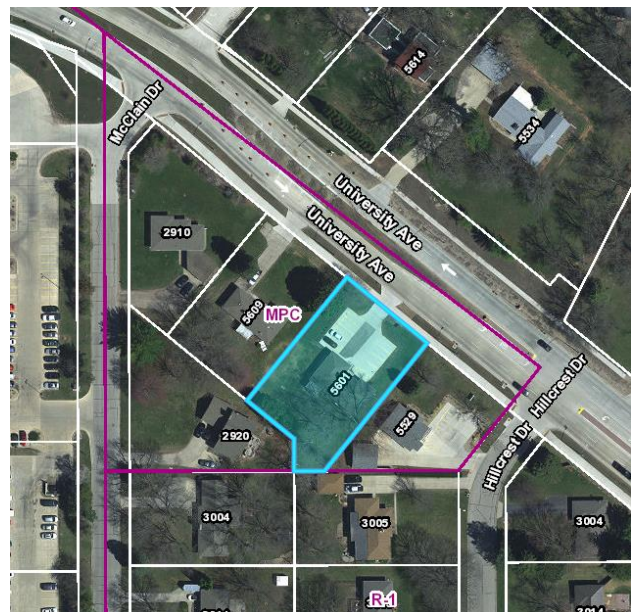

property located within the MPC district requires a site plan review by the Planning and Zoning Commission and City Council. The proposed 24' x 36' detached storage shed and the proposed modifications to the existing parking lot layout are considered significant changes.

ANALYSIS

The MPC District is intended to facilitate transition from residential uses to light commercial uses. It was specifically adopted for the University Avenue corridor. One major consideration in this zoning district is to protect existing adjacent residential properties from potential negative impacts of commercial uses. Such protection measures can include building design considerations, screening, setbacks, and limitations on the use or direction of lighting and limitations on the use of exterior speaker systems. A major advantage to the MPC district is that a site plan is required at the time of rezoning as well as when any future significant changes to the site (such as redevelopment) are proposed.

The following is a review of the MPC ordinance requirements:

Permitted use: The MPC district is intended to permit the development of a mixture of residential, institutional, professional office and commercial oriented land uses. A professional office with a showroom, specializing in redesigning kitchens, fits within the principle permitted uses of this district. The proposed shed will be used for additional storage for inventory, displays, tools and other items servicing the new business. Although not permitted as a primary use, the proposed storage shed is a permitted accessory use. **Criterion met.**

Building Setbacks: The 1,880 sqft footprint of the primary structure will remain the same. The proposed 24'x 36' (864 sqft) storage shed will be placed in the rear yard and needs to meet the setback requirements outlined in Section 26-126, Detached Accessory Structures. For this proposed detached structure, as it is larger than 600 sqft, a side yard and rear yard setback of at least 10' would be required. The submitted site plan shows a side yard setback of 10 feet and a rear yard setback of 15 feet. **Criterion met.**

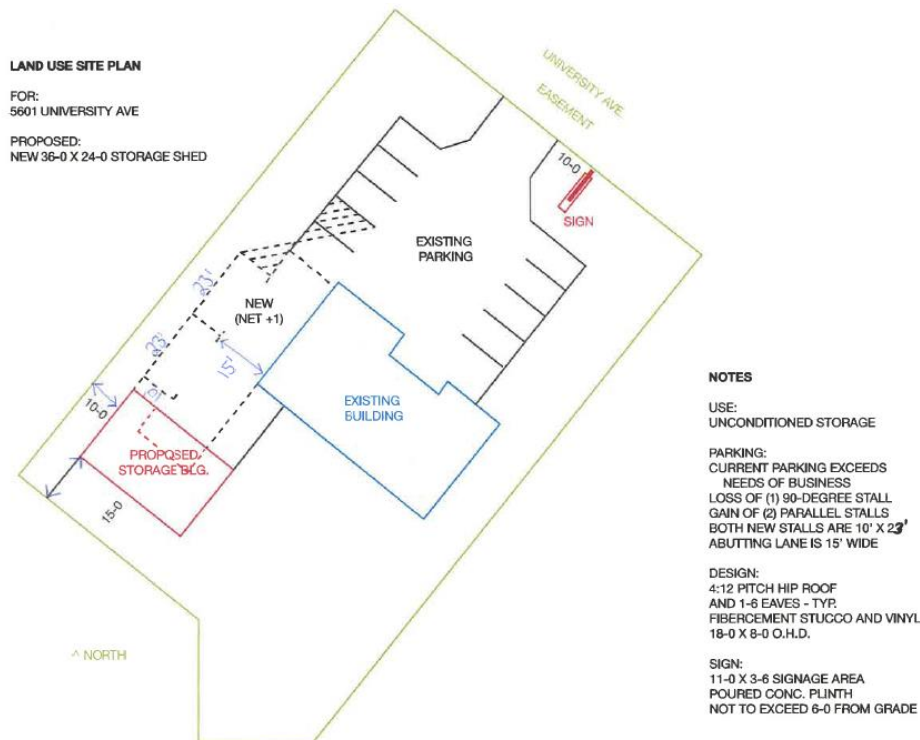

Minimum lot width: **Not applicable** in this review as the property is already zoned MPC.

Open Space: The proposed structure will not be located within the required open space perimeter of the district. **Criterion met.**

Landscaping/Screening: **Not applicable** as the existing and originally approved landscaping for the site will remain. See the 2016 approved and existing landscaping plan to the right. Note that the arborvitae along the north-western property line was not installed as the neighboring property was rezoned to MPC and as such this screening was no longer required. The existing line of trees and shrubs along the back of the property will help to screen the neighboring properties to the south from the proposed storage shed.

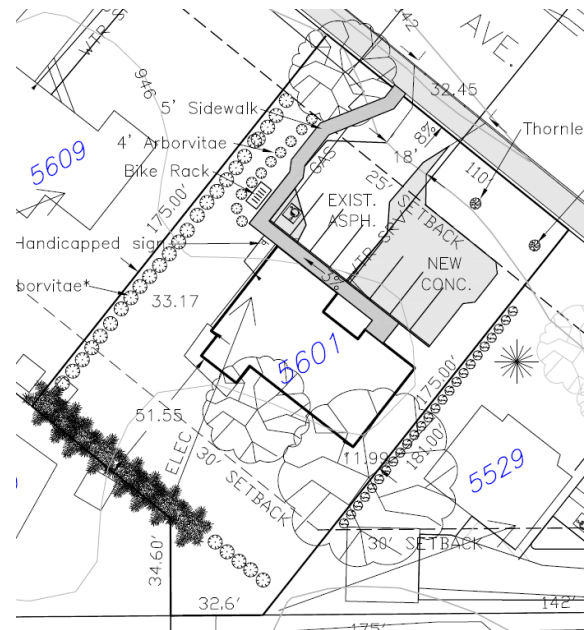

Street tree planting: **Not applicable** as the existing and originally approved landscaping for the site will remain. See the 2016 approved and existing landscaping plan above.

Building design: Buildings within the MPC district are required to match its neighboring properties. In this case the existing residential building will remain with minor improvements to the exterior (new siding and roofing). The interior of the building has been modified to accommodate commercial uses. The proposed storage shed will have a similar roof pitch to the primary building, include clerestory windows to break up the walls, and will match the siding of the primary building. In addition, the front of the shed will have a walk-in door and a double-size overhead door that mimic the appearance of a residential garage. This approach allows the site to continue to blend in with the existing look of the residential neighborhood. **Criterion met.**

Parking requirements: Professional offices within the City of Cedar Falls require one parking space for every 300 square feet of gross floor area, but in no case less than five parking spaces. The primary structure has an approximate floor area of 1,880 sqft. Six parking spaces would be required for this use. The 15 foot wide driveway to the storage garage would remove two of the existing parking spots on site. However, the applicant is proposing to add two new 10' x 23' parallel parking spots next to the storage shed entrance along the driveway. The minimum length for a parallel parking space is 23' and a minimum aisle width of 12' is required for safe access to them (Sec. 26-220, Table 1). With the addition of these two parallel spaces the proposed plan would maintain nine parking spaces onsite. **Criterion met.**

Building height: A primary structure in the MPC district can be a maximum of 30 feet high. The existing house is a single story structure well under the 30 foot maximum height. A detached accessory residential structure can have a maximum height of 18 feet (Sec. 26-126 (5)(a)). The proposed storage structure stands at a height of 18

feet. The height of the proposed shed is consistent with the residential character of the area. **Criterion met.**

Signage: The applicant is proposing one 11' x 3'6" lighted cabinet, freestanding sign with a cement base. The sign will not exceed six feet from grade. The sign will be located at the entrance of the business on private property, see attached site plan. The MPC district allows each property one monument sign no taller than six feet in height and no larger than 40 square feet in area. **Criterion met.**

Lighting: In the MPC district, it is required that any lighting used to illustrate any sign, parking area, or any portion of the premises shall be situated in such a manner that the light is reflected from adjoining residential premises. Aside from the freestanding sign, no other lighting was or is currently being proposed for this site. The proposed lighted cabinet, freestanding sign is perpendicular with University Avenue. Both properties neighboring 5601 University Avenue, to the east and west, are commercial properties. **Criterion met.**

TECHNICAL COMMENTS

All technical comments have been addressed.

STAFF RECOMMENDATION

The Community Development Department recommends approval of the amended site plan for 5601 University Avenue.

PLANNING & ZONING COMMISSION

Discussion/Vote
5/8/2019

Attachments:

- Letter of intent
- Site Plan
- Image representation of proposed storage shed

April 22, 2019

City of Cedar Falls
Planning and Community Services
220 Clay Street
Cedar Falls, Iowa 50613

SUBJECT: Site Plan Approval for 5601 University Avenue

To Whom It May Concern:

Last December I purchased a vacated commercial property, previously converted from a single-family home, at 5601 University Avenue. It was at that point, my husband and I decided to add another aspect to what we have been doing for years in homebuilding. Until now, our passion for modern design was exclusive to new construction. Design Lab will open this opportunity to everyone in the Cedar Valley, in addition to, creating two new full-time jobs!

This new business will hold open store hours later this year, but we are taking appointments now! We offer full-service kitchen design supported by Dura Supreme, Wolf Home Products and several local cabinetmakers. In addition we provide extensive options for countertops, flooring, millwork and hardware. Some of these brands include Silestone, Cambria, Dekton, Wilsonart, Shaw and Mohawk flooring, American Olean tile, Top Knobs and much more!

Design Lab is quietly up and running in our new space. This was after a number of superficial interior improvements were made to the showroom and office area earlier in the year. Though most of the products we sell will be shipped directly to job-sites and clients' homes, we need additional storage for inventory, displays, tools and other items. It is our intent to construct an 840 square foot building at the southwest corner of the property to satisfy these needs.

The new building will maintain the 4:12 roof pitch and 1'6" overhangs of the main building (formerly a house). With 9' high walls on slab construction, the roofline elevation should be similar as well. The required setback for a building of this nature is 10', which we intend to keep to at the westerly boundary. As illustrated on our site plan, we chose to place the back of the building at 15' in an effort to save a long row of 30' tall arborvitaes. This preserves an attractive, natural buffer.

Though the current parking lot considerably exceeds any demand by our business, we forfeit one stall in order to gain clear access to a lane connecting the parking lot and the new building. To ensure we do not lose any parking, we added two oversized parallel spaces abutting the lane. It is our expectation that these new stalls may be used by staff, if at all.

The front of the building will have a walk-in door, in addition to a double-size overhead door (a common size found on an ordinary garage), for loading and receiving. Both side walls will feature clerestory windows to break up the appearance. We currently have an active building permit in place on the existing building for complete replacement of roofing, soffit, fascia, gutters and siding. The windows are being refinished in black to match the new eaves. This stylish, dark theme extends to selections for other premium materials to be used on the walls. These surfaces will be comprised of an attractive combination of stucco, cumaru shiplap and architectural steel panels. The proposed building will share the same materials and treatments (represented by the rendering enclosed).

Thank you for your help in getting these improvements under way. Please let me know if you have any questions!

Respectfully,



Lori Larson
Owner

LL:kl
Encl. (2)

LAND USE SITE PLAN

FOR:
5601 UNIVERSITY AVE

PROPOSED:
NEW 36-0 X 24-0 STORAGE SHED

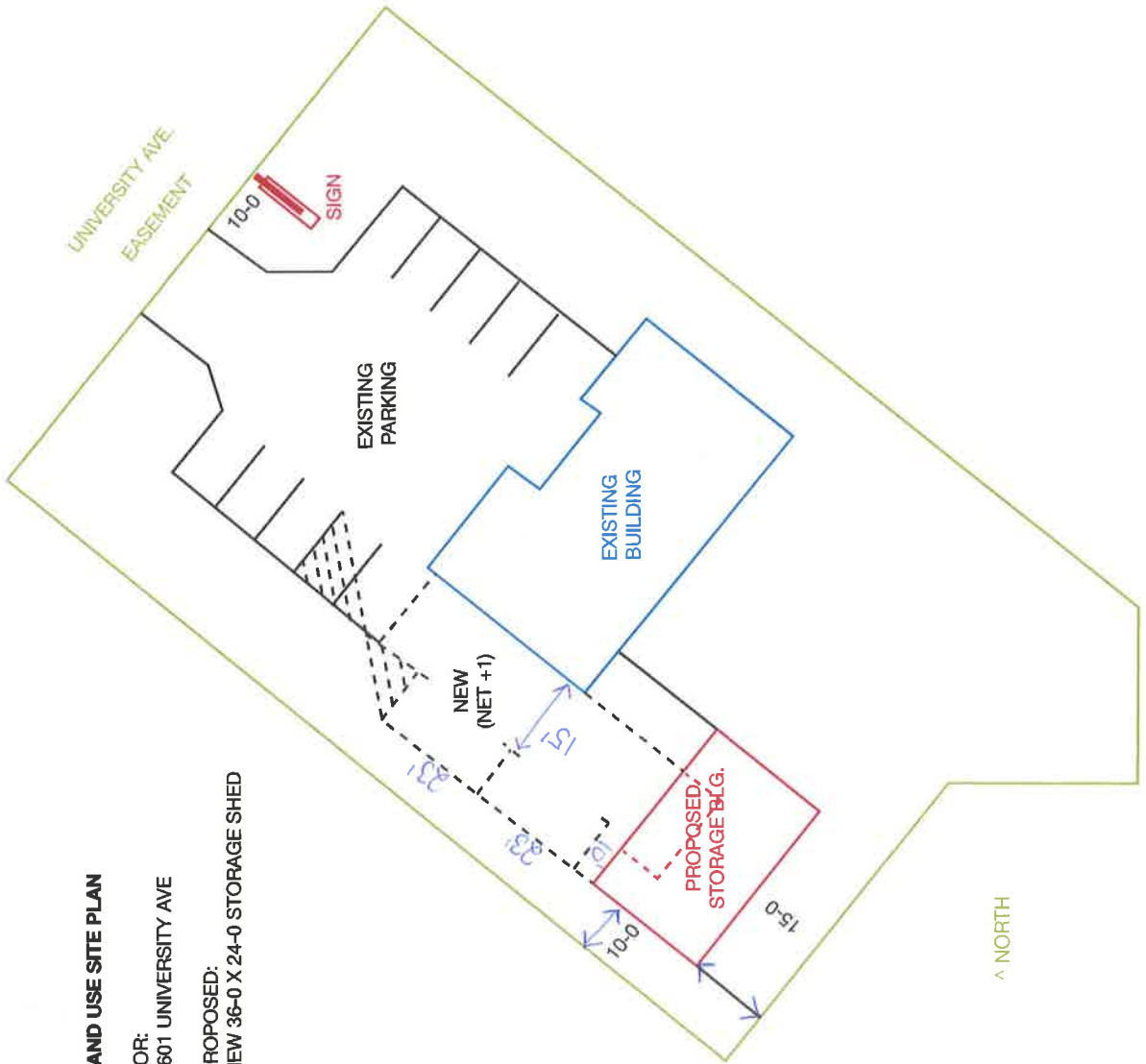

NOTES

- USE:
UNCONDITIONED STORAGE
- PARKING:
CURRENT PARKING EXCEEDS
NEEDS OF BUSINESS
LOSS OF (1) 90-DEGREE STALL
GAIN OF (2) PARALLEL STALLS
BOTH NEW STALLS ARE 10' X 23'
ABUTTING LANE IS 15' WIDE
- DESIGN:
4:12 PITCH HIP ROOF
AND 1-6 EAVES - TYP.
FIBREMENT STUCCO AND VINYL
18-0 X 8-0 O.H.D.
- SIGN:
11-0 X 3-6 SIGNAGE AREA
POURED CONC. PLINTH
NOT TO EXCEED 6-0 FROM GRADE

design lab

Proposed detached storage building to match improvements of main building. Includes clerestory windows, service door and overhead door for loading and receiving.





DEPARTMENT OF COMMUNITY DEVELOPMENT

City of Cedar Falls
220 Clay Street
Cedar Falls, Iowa 50613
Phone: 319-273-8600
Fax: 319-273-8610
www.cedarfalls.com

MEMORANDUM

Planning & Community Services Division

TO: Planning and Zoning Commission
FROM: Iris Lehmann, Planner II
DATE: April 30, 2019
SUBJECT: Rezoning Request – 2600 Grove Street

REQUEST: Rezone property from R-3, Multiple Residence District to C-2, Commercial District. (Case #RZ19-004)

PETITIONER: City of Cedar Falls

LOCATION: 2600 Grove Street

PROPOSAL

Through the review of a mobile merchant application, it was brought to City Staff's attention that the property at 2600 Grove Street was incorrectly zoned R-3, Multiple Residence District in 1970. To correct this mapping error staff is requesting to rezone this property to C-2, Commercial District.

BACKGROUND

2600 Grove Street has been zoned R-3, Multiple Residence District since the adoption of the Zoning Ordinance in 1970. 2600 Grove Street is a pole frame metal warehouse built in 1969 that services the businesses at 6912 University Avenue located directly to the south. The C-2, Commercial district boundary follows this property's western and southern property lines. See map to the right, the purple lines indicate the zoning district boundaries and the property in question is shaded in yellow. The building is a non-conforming use under the R-3 zoning standards but would be a conforming use in C-2 zoning. As the use

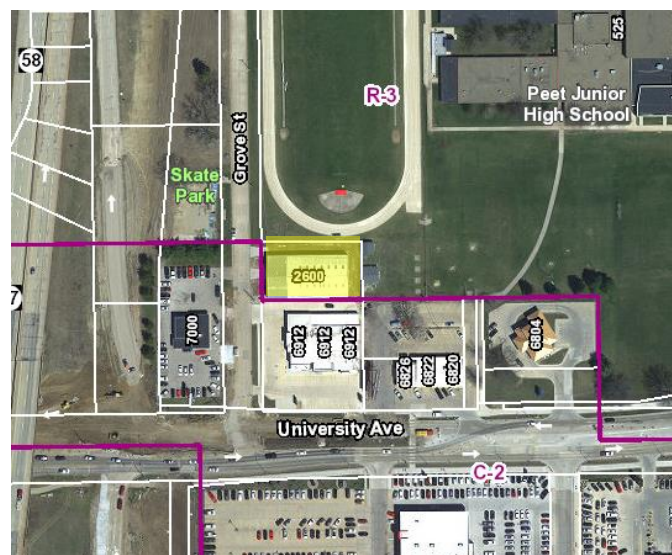

was in place before the zoning boundaries were drawn in 1970, staff can only assume that an error was made when the boundaries of the districts were determined.

ANALYSIS

The R-3, Multiple Residence District is a zoning district meant for medium density residential development. This district also allows for religious, educational, or philanthropic institutions, hospitals, and private clubs. A pole frame metal warehouse servicing commercial uses does not fall into the intended uses of this district.

This 0.39 acre property has commercial development to the south and west. Peet Junior High School is directly north and east of this property. No portion of this parcel is located in the floodplain. There are no sensitive areas within this rezoning request.

Rezoning considerations normally involve evaluation of three main criteria:

- 1) *Is the rezoning request consistent with the Future Land Use Map and the Comprehensive Plan?*

Yes. The Future Land Use Map designates this property, outlined in yellow in the map to the right, as a “Commercial Corridor”, area shaded in red. This designation is consistent with a commercial zoning designation and the rezoning request to C-2.

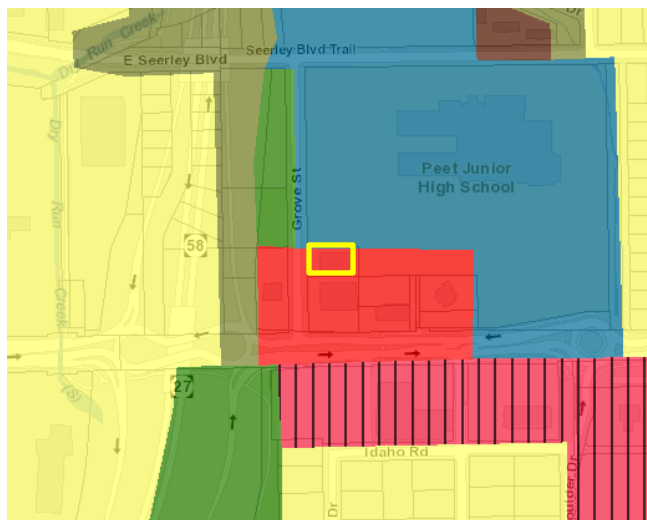

- 2) *Is the property readily accessible to sanitary sewer service?*

Yes, all utilities are readily available to the site.

- 3) *Does the property have adequate roadway access?*

Yes, the property currently has access to Grove Street which can be accessed from either University Avenue or E Seerley Boulevard.

As part of the technical review of this proposal, Cedar Falls Utilities personnel, have no concerns with the proposed rezoning request.

A notice was mailed to property owners within 300 feet of the parcel under consideration on April 30, 2019 regarding this rezoning request.

STAFF RECOMMENDATION

Gather any comments from the Planning and Zoning Commission and public then continue the discussion on this rezoning request and set the date for public hearing for the next Planning and Zoning Commission meeting on May 22, 2019.

PLANNING & ZONING COMMISSION

Introduction

5/8/19



DEPARTMENT OF COMMUNITY DEVELOPMENT

City of Cedar Falls
220 Clay Street
Cedar Falls, Iowa 50613
Phone: 319-273-8600
Fax: 319-273-8610
www.cedarfalls.com

MEMORANDUM

Planning & Community Services Division

TO: Planning & Zoning Commission
FROM: Shane Graham, Economic Development Coordinator
DATE: May 2, 2019
SUBJECT: Highway-1 District Site Plan Review

REQUEST: Site plan approval for a new Dairy Queen restaurant and a convenience store/gas station/automobile service station.
PETITIONER: Martin Rouse (developer); Fehr-Graham (engineer); Peters Construction (contractor); AHTS Architects (architect)
LOCATION: Lot 2 of Gateway Business Park at Cedar Falls

PROPOSAL

The developer, Martin Rouse, is requesting approval of a site plan to construct a new DQ Grill and Chill restaurant and a convenience store/automobile service station on Lot 2 of Gateway Business Park at Cedar Falls I, which is located at the northeast corner of Hudson Road and W. Ridgeway Avenue (highlighted lot on the image to the right). The lot will have one main access from Cyber Lane, with a secondary access coming via an access easement from Lot 1 to the north (Holiday Inn & Suites Hotel). No access to the site will be gained directly from W. Ridgeway Avenue or Hudson Road.

BACKGROUND

Lots 1 and 2 of Gateway Business Park at Cedar Falls I, along with the stormwater detention basin parcel, were platted in June of 2018. Currently, a Holiday Inn & Suites Hotel and conference center is under construction on Lot 1. Cyber Lane, which was also approved as part of the plat, will be completed in 2019.

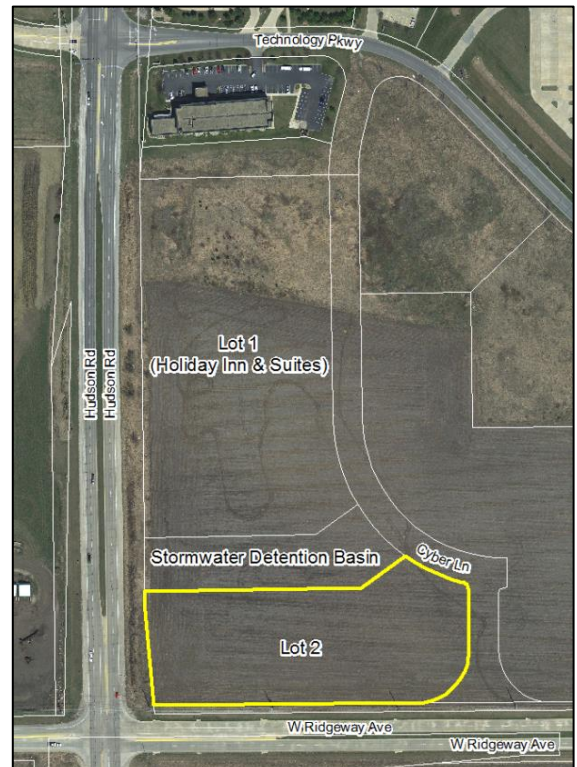

Lot 2 – Proposed Project Location

ANALYSIS

The property is zoned HWY-1, Highway Commercial District, which is intended to promote general services commercial uses intended to serve a broader market area (i.e. City-wide or regional customer base). The property is also located within the Highway 20 Overlay District, which provides enhanced development guidelines for commercial uses located within this corridor. The ordinance requires detailed site plan review in order to ensure that the development site satisfies a number of basic aesthetic standards. Attention to details such as parking, open green space, landscaping, signage, building design and other similar factors help to ensure orderly development in the entire area. Following is a review of the zoning ordinance requirements:

- 1) Use: A restaurant is listed as a permitted use within the Highway 20 Commercial Corridor Overlay District. A gas station/convenience store can also have a regional customer base, thus fitting within the permitted uses of the Highway 20 Commercial Corridor Overlay District. A service station is listed as a conditional use within the Highway 20 Commercial Corridor Zoning District. A conditional use may be permitted within this district subject to approval by the Planning & Zoning Commission and City Council. Factors to be evaluated in consideration of allowing such a use involve the site location relative to key entry points into the city (i.e. in the vicinity of the Hudson Road and Highway 58 intersections with W. Ridgeway Avenue). It is recommended that conditional uses be located on properties at least 300 feet from the Hudson Road and Highway 58 right-of-way lines. The service station use of this development is located approximately 475 feet from the right-of-way line of Hudson Road. **The restaurant and convenience store are permitted uses. The service station is a conditional use, and exceeds the recommended setback guidelines from Hudson Road.**
- 2) Setbacks: 20-ft. setbacks are required along the edge of the district and along any internal streets/principal access ways. These areas must be landscaped. Open space and landscaping is shown on the plan within these areas. Both the restaurant and convenience store/service station buildings meet the setback requirements. **Building setbacks are satisfied.**
- 3) Parking/Access: A restaurant is required to provide 1 parking space for every 100 square feet of gross floor area, plus 1 parking space for every 2 employees with a minimum of 5 parking spaces for employee parking. A convenience store is required to provide 1 parking space for every 100 square feet of retail floor space, plus 1 parking space for every 2 employees. There is no specific definition of service stations in the parking section, however the ordinance indicates that the number of parking spaces shall be that of a similar use as determined by staff. In looking at the parking space use requirements, the closest comparison would be that of a fuel service center, which requires 2 parking spaces for each service stall. Staff feels that since the service center would have bays for cars, that the parking requirements for a fuel service center would be comparable.

Based on the above requirements, the total site would be required to provide 78 parking spaces. As you can see from the chart below, the property is providing 115 parking spaces, 37 more spaces than what is required. Please reference the chart below to see the breakdown of required and provided parking by uses.

| Use | Required | Provided |
|-------------------|-----------|------------------------------------|
| Restaurant | 17 | 85 (shared with convenience store) |
| Convenience Store | 49 | 85 (shared with restaurant) |
| Service Station | 12 | 30 |
| Total | 78 | 115 |

Access to the property will be gained from two different locations. There will be one main access from Cyber Lane at the northeast corner of the property. There is also a 65' wide access easement provided from Lot 1 (Holiday Inn & Suites Hotel) to allow access to this site at the northwest corner of the property. If using this access, access can be gained onto Hudson Road through a right-in right-out on the hotel site.

The main area in front of the convenience store/gas station near the gas canopy does appear to have a large quantity of concrete, as there is 39' from the parking area at the west end of the site to the gas canopy, and 42' from the parking lane in front of the building to the gas canopy. There will be no semi-trucks fueling at this site, so staff would question if this concrete area could be reduced.

Overall, the submitted parking lot and access plan is satisfied.

- 4) Open Green Space: This property is located within the Highway 20 Commercial Corridor Overlay Zoning District. This overlay district requires that open green space/landscape area be provided at the rate of 15% of the development site. Following is a summary from the landscape plan that details how this provision is met.

| | | |
|----------------------------------|------------------|--------------|
| <u>Development Site</u> | 190,358 SF | |
| Required Open/Green Space | 28,554 SF | 15% |
| Provided Open/Green Space | 52,708 SF | 27.7% |

Landscaping is shown throughout the site, both within the green space areas in the parking lot and around the buildings and along the street frontages. **The open green space exceeds the minimum requirement and is well distributed.**

- 5) Landscaping: The Highway 20 Commercial Corridor Overlay District requires landscaping at the rate of 0.02 points per sq. ft. of total development site area. Following are the requirements for the convention center site and new hotel site and what is proposed.

| <i>Description</i> | <i>Required</i> | <i>Proposed</i> |
|--|------------------|------------------|
| Development Lot 190,358 * .02 | 3,808 pts. | 4,974 pts. |
| Parking lot trees 115/15 = 8 trees @ 80 pts. | 640 pts. | 1,520 pts. |
| Street Tree Planting (.75 points per linear foot → 1,330' on Hudson Rd, W. Ridgeway Ave and Cyber Ln) | 998 pts. | 1,606 pts. |
| | 5,446 pts | 8,100 pts |

As detailed in the table, trees are required in the vehicular use area at the rate of one tree per 15 parking spaces. With a total buildout of 115 parking spaces, 8 trees would be

required. The landscape plan shows a total of 19 trees within the parking area, which would exceed the requirement.

In addition to parking lot trees, there are trees located along the street frontages, and trees located along the north property line to screen the site from the storm water detention basin and hotel to the north. In total, there will be 60 trees and 578 shrubs and grasses planted on the site.

In order to help screen the automobile service station use from the surrounding properties and roadway, the landscaping to the south and east of the building along W. Ridgeway Avenue and Cyber Lane will be constructed on top of a small berm. This berm will add an additional form of screening from the building and parking area of the service station in addition to the landscape plantings. **Landscaping requirements are met.**

- 6) Sidewalks/Recreational Accommodations: A new 10-foot wide recreational trail will be installed along Hudson Road and W. Ridgeway Avenue. This will be completed by the current owner of the property (also the owner of the Holiday Inn & Suites Hotel). A connection from this trail to the property is shown near the northwest corner of the property. This will allow pedestrian access to the DQ Grill and Chill. There is another connection from the trail to the property along the south side of the property. This will allow pedestrian access to the convenience store. Also, a new 5' wide sidewalk will also be installed along Cyber Lane, and would have a connection point to the site at the entrance to the property along Cyber Lane. **Trail/sidewalk plan satisfied.**
- 7) Building Design: The HWY-1, Highway Commercial District states that all structures established within the district shall be reviewed for architectural compatibility with surrounding structures. Below is a review on the elements that are to be addressed.

Proportion: The relationship between the width and height of the front elevations of adjacent buildings shall be considered in the construction or alteration of a building; the relationship of width to height of windows and doors of adjacent buildings shall be considered in the construction or alteration of a building.

The scale and proportion of both of the proposed buildings will be similar to existing buildings in the area, except for the hotel located adjacent to the north, which will be 4 stories in height, and the proposed buildings will only be one story. However, many of the office buildings located within the technology park nearby to the north are single-story buildings.

Roof shape, pitch, and direction: The similarity or compatibility of the shape, pitch, and direction of roofs in the immediate area shall be considered in the construction or alteration of a building.

The design of both buildings includes a flat roof with a parapet wall. The hotel to the north, as well as a number of industrial and office uses nearby utilize flat roofs as well, so this roof design will not be out of character with the area.

Pattern: Alternating solids and openings (wall to windows and doors) in the front facade and sides and rear of a building create a rhythm observable to viewers. This pattern of solids and openings shall be considered in the construction or alteration of a building.

The restaurant building was designed with a brick base around the entire building, with cultured stone veneer being located over the entrance, drive through window and front of the building. The top portion of the south and west facing sides of the building will also have metal accent panels. This horizontal pattern of brick, coupled with the vertical pattern of the cultured stone veneer, provides some visual interest to the building. The convenience store/automobile service station building was similarly designed with a brick base, and like the restaurant building, the entrances to this building will have that brick material extend to the top of the wall as well. In addition, brick materials extend near the roof line in each corner of the building to add detail to those areas, while allowing the main entrances of the building to stand out more with the brick materials going to the top of the wall.

The primary façade (south and west sides) of the restaurant has an alternating pattern of windows and a main entrance feature that provide views and openings into the building. Decorative awnings are also found above the windows and entrances along the primary facades. Above the windows is a decorative canopy with metal accent panels above, which go to the roof line. These elements provide a visually interesting rhythm to the primary façade. The rear and drive through side of the store (east and north sides of the building) will feature mainly the brick base, EIFS, and cultured stone veneer over the drive through window. There are no windows on these sides of the building, as they encompass the employee and storage areas of the interior of the building. It should be noted that the enhanced facades of the building are facing the public streets.

The primary façade (west and north sides) of the convenience store/automobile service station has a similar alternating pattern of windows and main entrance features to provide views and openings into the building. Decorative awnings are found over the windows on this building, similar to the ones found on the restaurant building. These features provide a visually pleasing main entrance into the building. The east side of the building is made up of 6 service bay doors for vehicles, which are made up of nearly all glass. The south side of the building has brick columns at the corners, and a service door which leads to the trash enclosure, however there are windows and awnings found near the corner of the building where the convenience store portion is located.

The buildings were created with a contemporary design approach to meet the standards of the restaurant company while also adapting to local conditions resulting in a more custom design for the building. Exterior materials were designed with a strong masonry base, such as the brick and stone, with a consistent pattern at the entrances and a defined top with an enhanced cornice.

Materials and texture: The similarity or compatibility of existing materials and textures on the exterior walls and roofs of buildings in the immediate area shall be considered in the construction or alteration of a building. A building or alteration shall be considered compatible if the materials and texture used are appropriate in the context of other buildings in the immediate area.

The front of the restaurant (south facing side) will feature brick, cultured stone, EIFS, metal accent panels and glass. These materials are commonly found on other buildings within the area. The metal accent panels will be orange in color, while the other materials will be in several different earth tone colors. The restaurant's name and logo will be located in front of the building and above the main entrance.

The convenience store/automobile service station will also feature brick, EIFS, and glass. Brick material will be a darker earth tone, with a lighter tone stone cap. The EIFS material will also be lighter earth tone in color. Signage will be located above the main entrances and windows of the north and west sides of the building. As with the restaurant building, these types of building materials are commonly found on other buildings in this area.

Color: The similarity or compatibility of existing colors of exterior walls and roofs of buildings in the area shall be considered in the construction or alteration of a building.

Many of the existing buildings in this area utilize a neutral color exterior, which include brown, tan, and cream. Some buildings also utilize red or gray tones as well. The restaurant building will include a darker brown shade of brick, along with a lighter shade of cultured stone and EIFS to provide contrast. Awnings above the windows will be red in color. Metal accent panels along the upper portion of the front and side of the building will be orange in color. Staff feels that the amount of red and orange that is incorporated into the building does not take away from the overall look of the development and provides additional visual interest to the facades.

The convenience store/automobile service station building will also include a darker brown shade of brick, along with a lighter shade of EIFS to provide contrast, just like the restaurant building. Awnings above the windows on this building will be purple in color. Just like

the restaurant building, staff feels that the amount of purple that is incorporated into the building does not take away from the overall look of the development and provides additional visual interest to the facades.

Architectural features: Architectural features, including but not limited to, cornices, entablatures, doors, windows, shutters, and fanlights, prevailing in the immediate area, shall be considered in the construction or alteration of a building. It is not intended that the details of existing buildings be duplicated precisely, but those features should be regarded as suggestive of the extent, nature, and scale of details that would be appropriate on new buildings or alterations.

Architectural features of the restaurant include fabric awnings over each of the windows, as well as a cornice that is located at the very top of the cultured stone wall at the front of the building. The building also incorporates orange metal accent panels on the upper portions of the front and side walls. The convenience store/auto service station will also have fabric awnings located over the windows like the restaurant building, as well as a cornice that is located above the main facades of the north and west walls. It should be pointed out that the rear of the building faces a heavily traveled street in W. Ridgeway Avenue. Staff would request that this side of the building have the same cornice feature that is found along the main facades of the building, in order to give it a more pleasing look like the main facades of the building.

Overall, the design of the proposed restaurant and convenience store/gas station/auto service station is architecturally compatible with other buildings in the surrounding area.

- 8) Trash Dumpster Site: Two trash enclosures will be located on the site; one for the restaurant and one for the convenience store/service station. The trash enclosure for the restaurant will be located at the southeast corner of the property and will be fully enclosed with a gate on the front. This enclosure will also have landscaping around it to help screen it from view. The trash enclosure for the convenience store and service station will be located on the south side of the building. This enclosure will look like it is part of the rear of the building, as the wall of the building will extend out and enclose the dumpster area, thus completely screening it from view. **Dumpster enclosure plan is acceptable.**

- 9) Lighting Plan: The HWY-1 District regulations do not have specific lighting design guidelines. The site plan shows the location of light poles throughout the site. The parking lot lights will be mounted atop a 25' tall light pole with a 3' concrete base. The fixtures will be housed in a die-cast aluminum housing with LED lights. Also, recessed LED lighting will be provided under the gas canopy to provide light to the customers who are fueling their vehicles.

Lighting plan is acceptable.



LED Parking Lot Fixture

10) Signage: There are three signs illustrated on the site plan: one at the southwest corner of the property near the intersection of Hudson Road and W. Ridgeway Avenue, one at the southeast corner of the property near the intersection of W. Ridgeway Avenue and Cyber Lane, and one near the northeast corner of the property at the main entrance to the property along Cyber Lane. The main sign, located at the southwest corner of the property, will be 25 feet in height and 198 square feet in area. This sign will sit atop a 3 foot brick base.

Two smaller 6' tall, 70 square foot signs will be located at the southeast corner of the property near the intersection of W. Ridgeway Avenue and Cyber Lane, and one near the northeast corner of the property at the main entrance to the property along Cyber Lane. These signs will also sit atop a brick base like the main sign.

It should be noted that the property is located within the Highway 20 Commercial Corridor Overlay Zoning District. The signage requirements in this district state that one freestanding sign may be allowed that does not exceed 25 feet in height and 200 square feet in area. The main monument sign would meet those requirements. The ordinance goes on to state that smaller monument signs, measuring no more than 15 feet in height and 150 square feet in area, are permitted, with a maximum of two such signs per parcel. The parcel would have two such signs, at a size of 70 square feet each.



Main Monument Sign



Secondary Monument Signs

The proposed wall signs appear to be well within the District limitations of no larger than 20% of the wall area to which the wall sign is attached. However, this will be reviewed in detail at the time a sign permit is requested. **Signage plan generally meets the standards, pending a detailed review at the time a sign permit is requested.**

11) Storm Water Management: A storm water detention basin is located at the north end of the property to collect the storm water runoff from the site. The water runoff from the building and parking areas will be collected via intakes within the parking area and transferred via piping to the detention basin. Also, an oil skimmer will be provided within the intake near the fueling area in order to help stop any fuel or oil from reaching the detention basin. **Stormwater Management Plan has been reviewed and approved by the Engineering Division.**

TECHNICAL COMMENTS

Water, electric, gas, and communications utility services are available to the site in accordance with the service policies of Cedar Falls Utilities. The property owner/contractor is responsible to extend all utility services to the building. These utility extensions will be reviewed by CFU personnel as part of the building plan review.

STAFF RECOMMENDATION

The introduction of this site plan is for discussion and public comment purposes only. The Community Development Department has reviewed the plan and provides the following comments:

- 1) Addition of the cornice feature to the roof line along the south side of the convenience store/gas station/automobile service station building that faces W. Ridgeway Avenue.
- 2) Review of the concrete area in front of the convenience store/gas station building to see if there could be a reduction in the amount of concrete.
- 3) Any comments or direction specified by the Planning & Zoning Commission.

Subject to any comments being addressed, staff anticipates that this will be referred to the Planning and Zoning Commission for a vote on May 22, 2019.

PLANNING & ZONING COMMISSION

Discussion

5/8/2019

Vote

5/22/2019

LOT 2, GATEWAY BUSINESS PARK SITE PLAN

DEVELOPER
 MARTIN ROUSE
 320 G AVENUE
 GRUNDY CENTER, IOWA 50638
 P# 319 824 6004

ZONING (EXISTING & PROPOSED)
 HWY-1 & HWY-20 OVERLAY

PROPERTY DESCRIPTION
 LOT 2 OF GATEWAY BUSINESS
 PARK AT CEDAR FALLS

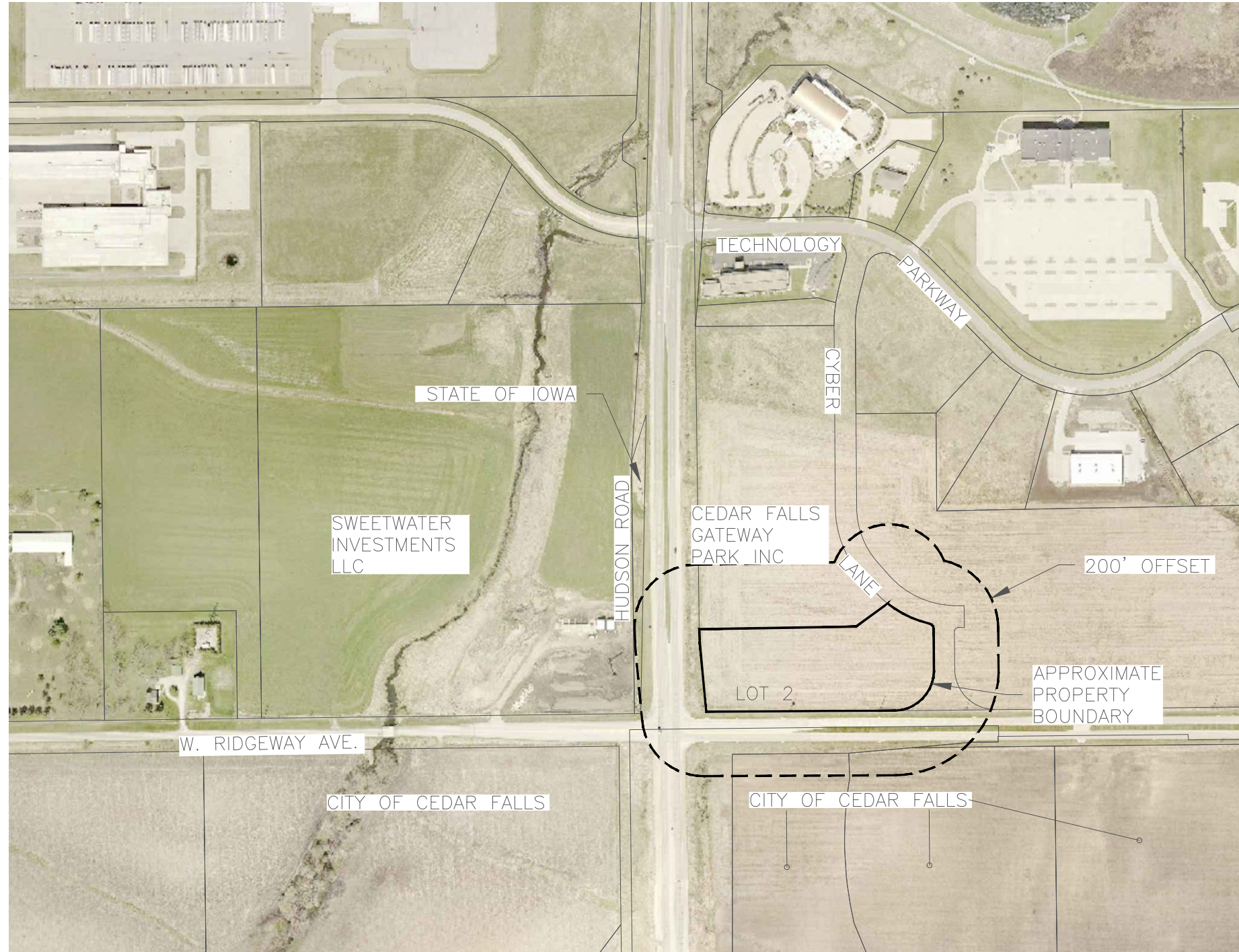

LOT AREA: 4.37 ACRES

BUILDING AREA: 24,444 SF

MINIMUM REQUIRED BUILDING AREA: 16,795 SF

OPEN SPACE: 1.21 ACRES

MINIMUM REQUIRED OPEN SPACE: 0.66 ACRE

RETAIL FLOOR AREA:
 -RESTAURANT: 1200 SF
 -CONVENIENCE STORE: 4400 SF
 -TOTAL: 5600 SF

PARKING SPACES PROVIDED: 115

MINIMUM REQUIRED PARKING SPACES:
 -RESTAURANT: 18+5 = 23
 -CONVENIENCE STORE: 44+5 = 49
 -SEMI CENTER: 12+5 = 17
 -TOTAL: 89

PROVIDED ACCESSIBLE PARKING SPACES: 6

REQUIRED ACCESSIBLE PARKING SPACES: 6

MINIMUM PARKING SPACE SIZE: 9'x19'

BUILDING HEIGHTS
 -RESTAURANT: 20' MAXIMUM
 -CONVENIENCE STORE: 16' BUILDING
 -CANOPY: 25' MAXIMUM

EXPECTED EMPLOYEES: 85-90 FULL & PART TIME BETWEEN BOTH BUSINESSES (ESTIMATE)
 (10 MAX PER SHIFT PER EACH BUSINESS)

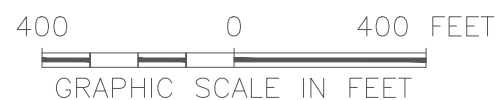
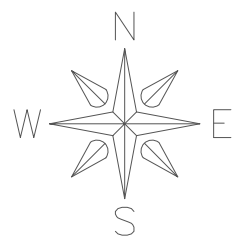

APRIL 22, 2019

ILLINOIS
 IOWA
 WISCONSIN

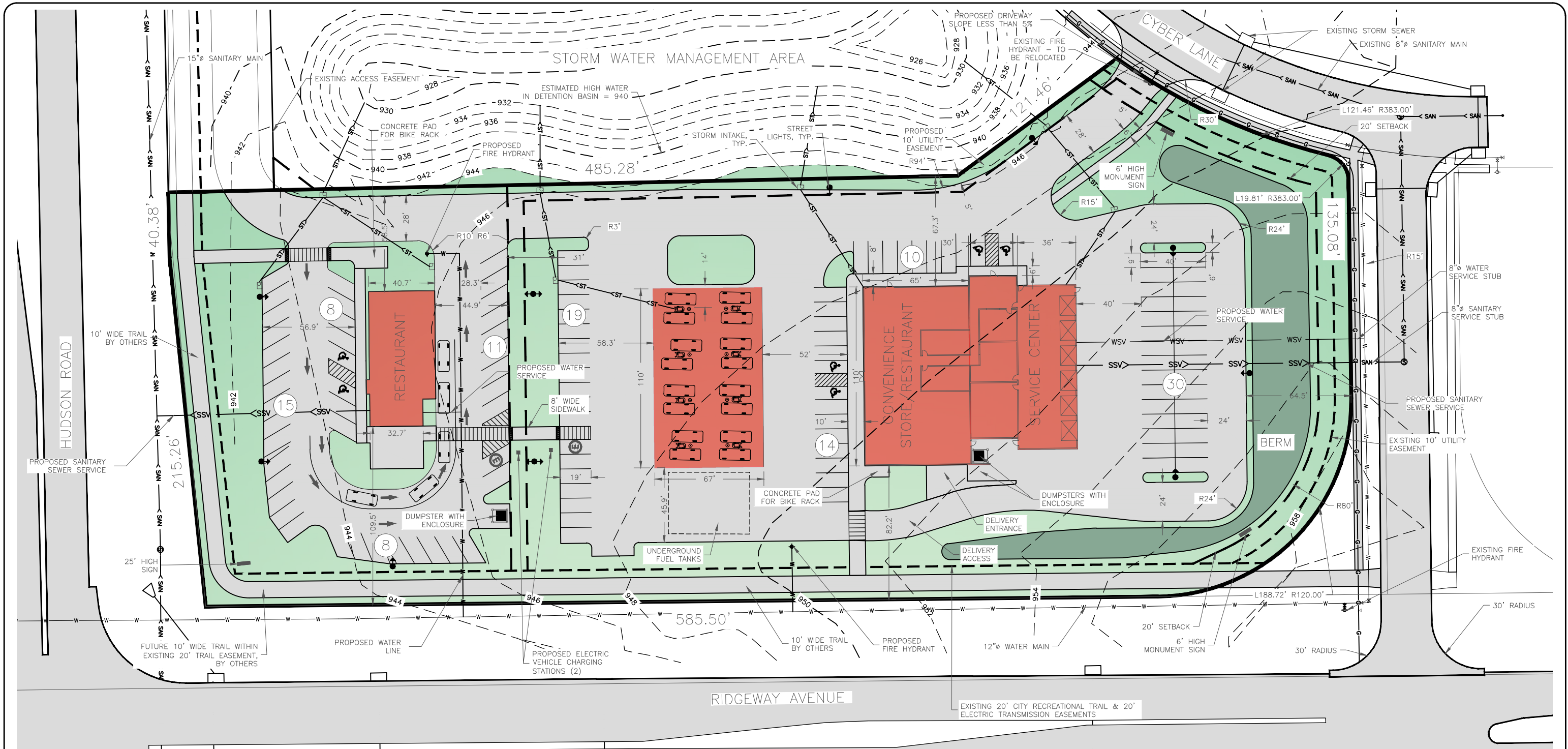

- ELECTRICAL AND COMMUNICATION LINES TO BE WITHIN UTILITY EASEMENTS
- CONVENIENCE STORE PARKING SPACES 9'X19'
- RESTAURANT PARKING SPACES 9.5'X19' @ 60°
- SERVICE STATION PARKING SPACES 9'X20'
- ALL PAVED AREAS TO BE PCC
- EXISTING & PROPOSED EASEMENTS ON LOT 2 ARE SHOWN.
- SIDEWALK ALONG CYBER LANE TO BE PROVIDED BY OTHERS.
- RECREATIONAL TRAIL TO BE PROVIDED BY OTHERS.
- ANY CONTOURS SHOWN ARE FROM GRADING PLAN FOR GATEWAY BUSINESS PARK

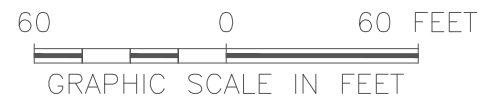
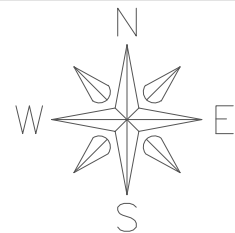

LOT 2 GATEWAY BUSINESS PARK DEVELOPMENT SITE PLAN



APRIL 22, 2019

ILLINOIS
IOWA
WISCONSIN

LOT 2 GATEWAY BUSINESS PARK DEVELOPMENT SIGHT TRIANGLE

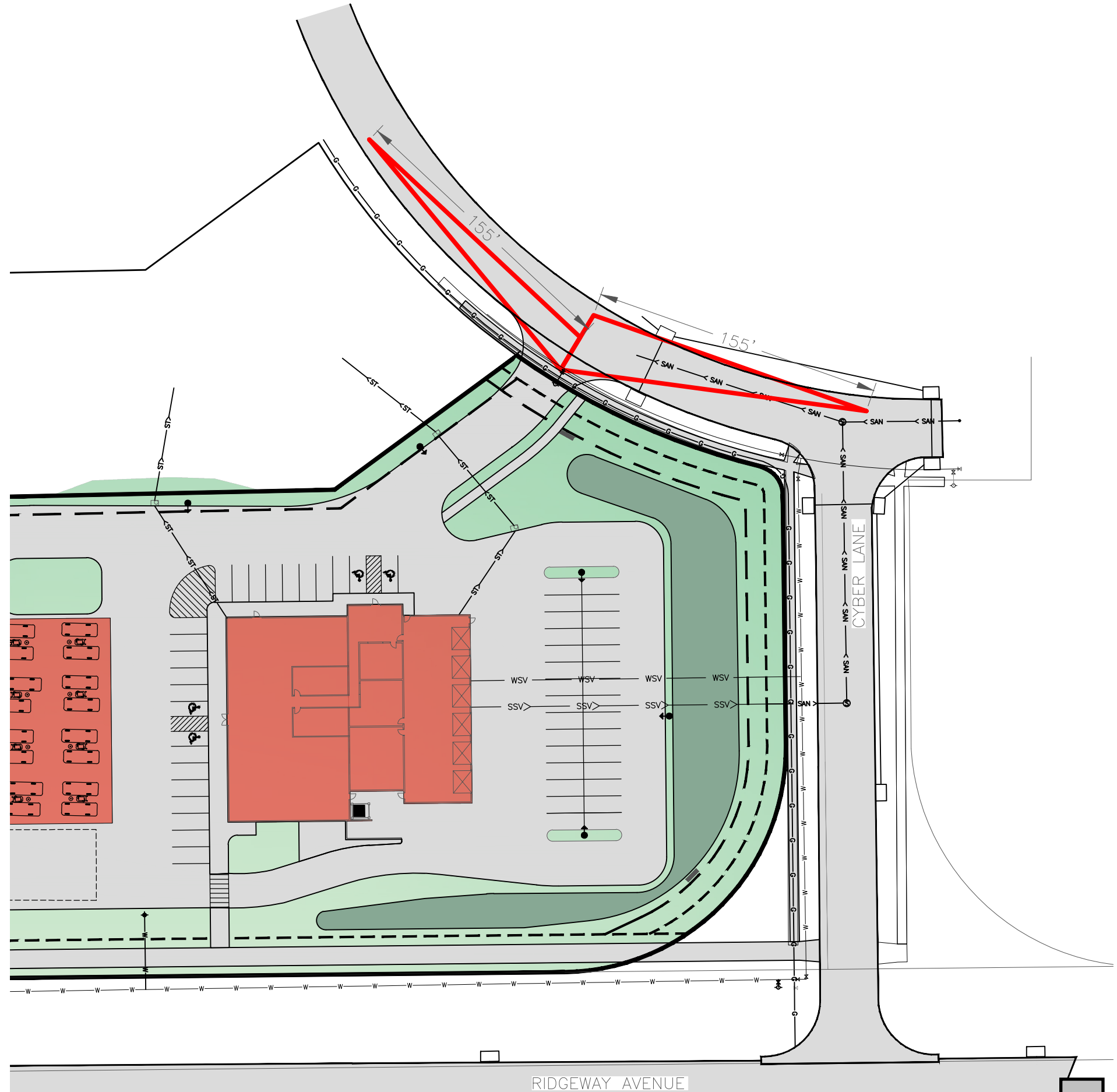

DISTANCE BASED ON 25 MPH

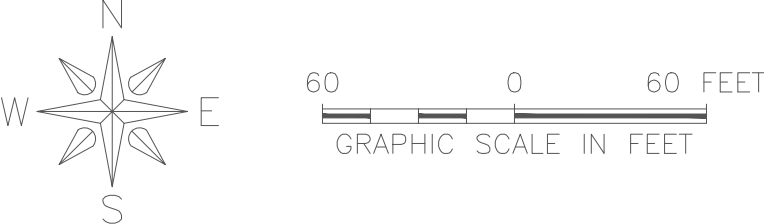

APRIL 22, 2019



ILLINOIS
IOWA
WISCONSIN





















| PLANT LIST | | |
|---|--|--|
| Quantity- Size/Points- | Variety | |
| Overstory Trees | | |
| 12 - 2" caliper/80 pts = 960pts. | Acer Plat "columnaire" 50x15 wide | |
| 2 - 2" caliper/80 pts = 160pts. | Gleditsia T. "Skyline" Honeylocust 40x40 wide | |
| 15 - 2" caliper/80 pts = 1,300pts. | Ginko Biloba 5x30 wide | |
| 31 - 6' ht. / 80 pts = 2,480pts. | Pinus Strobus "White Pine" 60x30 wide | |
| not ALL shown include in bid | | |
| 41 - 5 GAL/10 pts = 410 pts. | HYDRANGEA P. LIMELIGHT | |
| 324 - 2 GAL./5 pts = 1620 pts. | KARL FOERSTER GRASS | |
| 96 - 2 GAL/5 pts = 480 pts | HEMEROCALLIS DAYLILY "HAPPY RETURNS" | |
| 96 - 2 GAL/5 pts = 480 pts. | Rudbekia G. VAR "Sullivanti" | |
| 21 - 5 GAL/10 pts = 210 pts. | Juniperus communis var. depressa | |
| Total points provided = 8,000 | | |
| Total points required = 4,668 | | |
| Notes: | | |
| Rudbekia and Daylilies to be interplanted at high visibility areas in mulch beds. | | |
| Sq ft | Mulch areas to receive weed fabric and 2" depth of River rock mulch. | |
| Sq ft | Lawn areas to receive sod or seed provide alternate bids. | |
| | Large stone out crop grouping @ 4 Locations | |
| | Berm areas to be 3' Ht. | |
| PROVIDE 20" DEPTH OF APPROVED BLACK DIRT IN ALL PLANTING AREAS. | | |

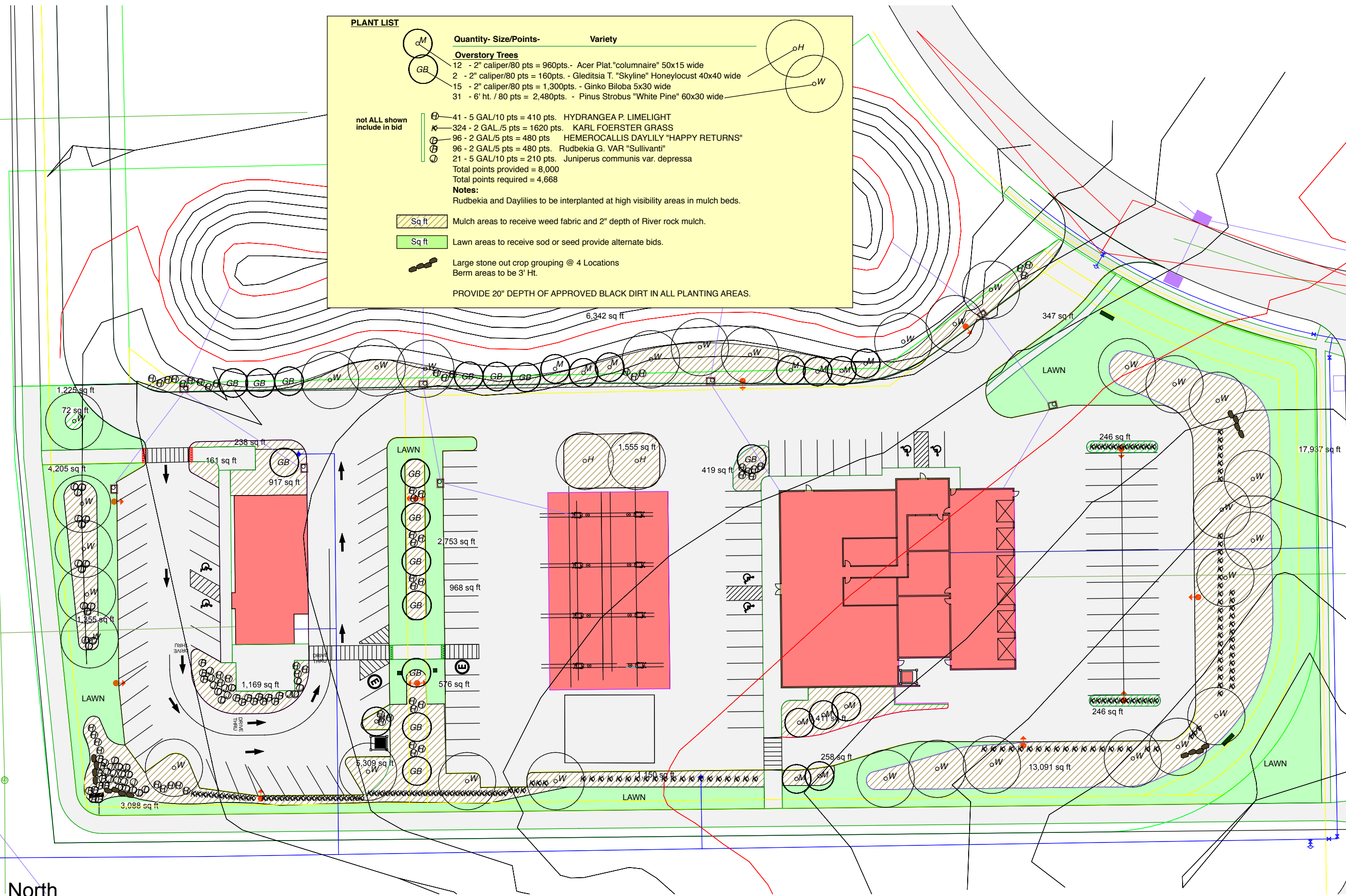

North
Planting Plan
 SCALE: 1" = 50'



327 East Fourth Street
 Suite 204
 Waterloo, Iowa 50703

Drawings and Specifications, ideas, designs, and arrangements represented here are and shall remain the property of the architect and shall not be reproduced, disclosed to others, or used in connection with any work or project other than the specified project for which they have been prepared without the written consent of the architect. Value contract with these plans and specifications shall constitute conclusive evidence of acceptance of these restrictions.

Rouse Development
 Ridgeway Avenue
 Cedar Falls, Iowa





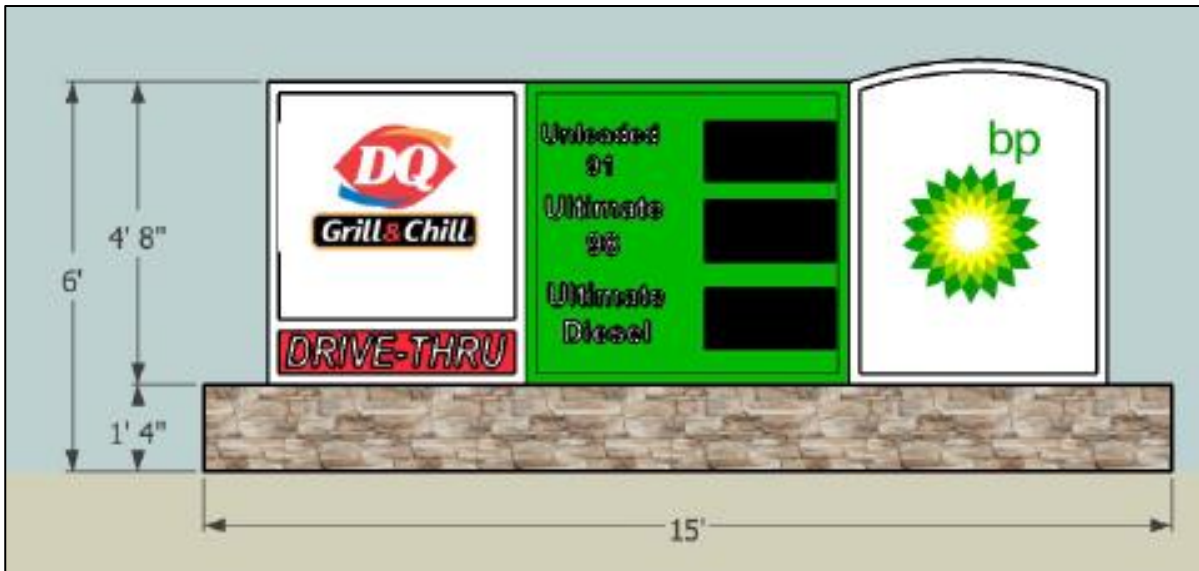

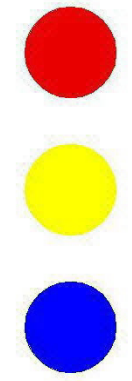
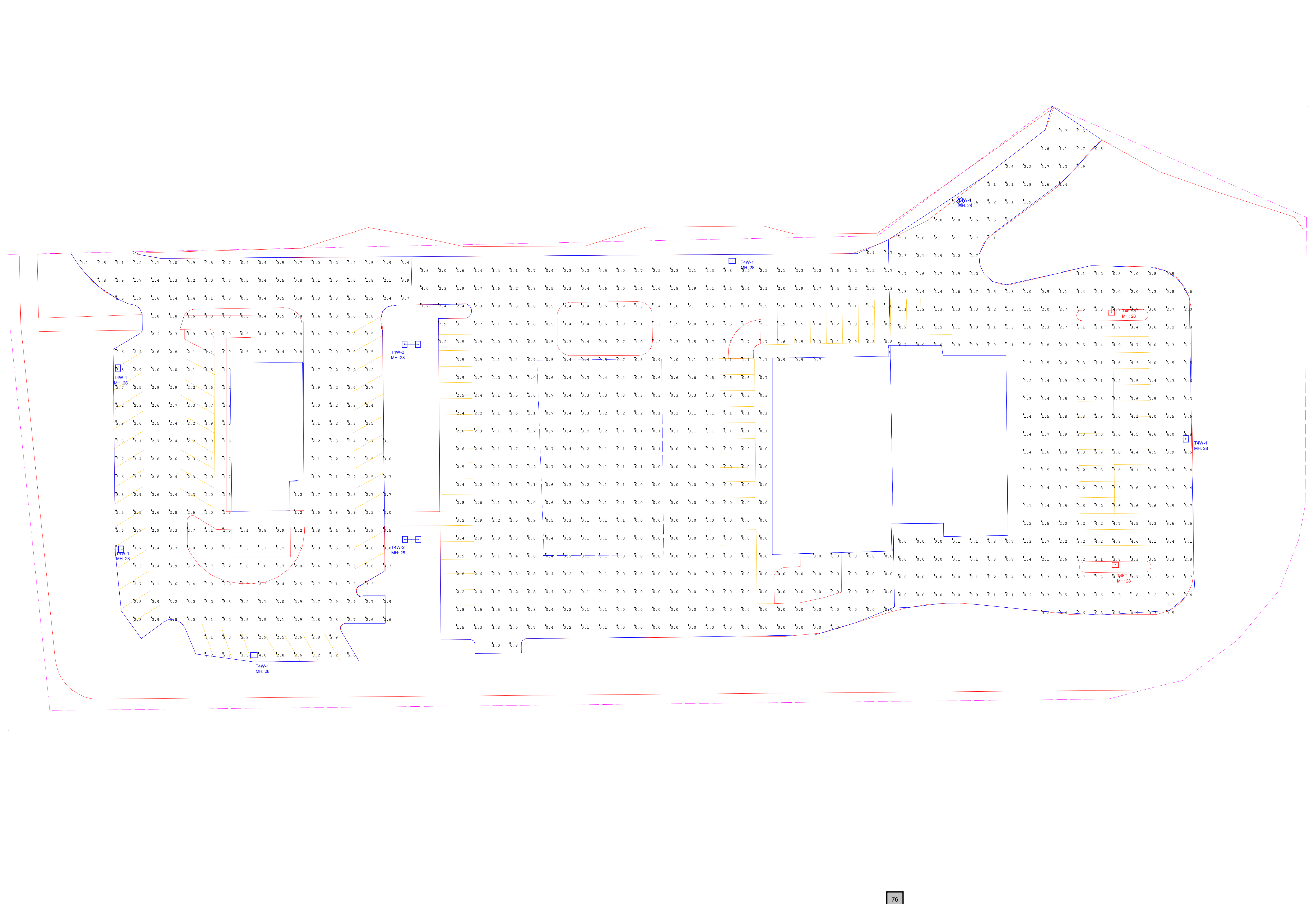

| Date | | | | |
|------|--|--|--|--|
| # | | | | |

Revisions

| | |
|----------------|--|
| Drawn By: TM | |
| Checked By: | |
| Date: 5/1/2019 | |
| Scale: NONE | |

GATEWAY BUSINESS PARK
SITE LIGHTING
PROPOSAL 2

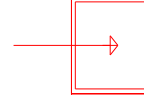
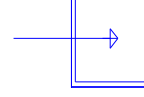
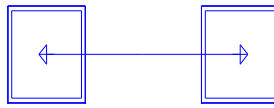
| Luminaire Schedule | | | | | | |
|---|-----|--------|-------------|-------------------|-------|-------------------------|
| Symbol | Qty | Label | Arrangement | Total Lamp Lumens | LLF | Description |
|  | 2 | T4FT-1 | SINGLE | N.A. | 0.900 | GLEON-AF-04-LED-E1-T4FT |
|  | 6 | T4W-1 | SINGLE | N.A. | 0.900 | GLEON-AF-04-LED-E1-T4W |
|  | 2 | T4W-2 | BACK-BACK | N.A. | 0.900 | GLEON-AF-04-LED-E1-T4W |

| Calculation Summary | | | | | | | |
|------------------------|-------------|-------|------|-----|-----|---------|---------|
| Label | CalcType | Units | Avg | Max | Min | Avg/Min | Max/Min |
| Fuel Pumps Lot_Top | Illuminance | Fc | 0.89 | 4.0 | 0.0 | N.A. | N.A. |
| Restaurant Lot_Top | Illuminance | Fc | 2.23 | 4.0 | 0.1 | 22.30 | 40.00 |
| Service Center Lot_Top | Illuminance | Fc | 2.14 | 4.9 | 0.0 | N.A. | N.A. |

NOTES: FIXTURES MOUNTED ON 25' POLES WITH A 3' CONCRETE BASE.
10'x10' CALC GRID ON ALL LOT SURFACES.

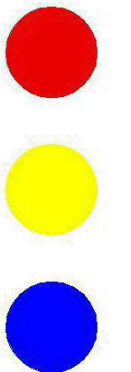

| # | Date |
|---|------|
| | |
| | |
| | |

Revisions

| |
|----------------|
| Drawn By: TM |
| Checked By: |
| Date: 5/1/2019 |
| Scale: NONE |

GATEWAY BUSINESS PARK
SITE LIGHTING
PROPOSAL 2

DESCRIPTION

The Galleon™ LED luminaire delivers exceptional performance in a highly scalable, low-profile design. Patented, high-efficiency AccuLED Optics™ system provides uniform and energy conscious illumination to walkways, parking lots, roadways, building areas and security lighting applications. IP66 rated and UL/cUL Listed for wet locations.

| | | |
|--------------------|--|-------------|
| Catalog # | | Type |
| Project | | |
| Comments | | Date |
| Prepared by | | |

SPECIFICATION FEATURES

Construction

Extruded aluminum driver enclosure thermally isolated from Light Squares for optimal thermal performance. Heavy-wall, die-cast aluminum end caps enclose housing and die-cast aluminum heat sinks. A unique, patent pending interlocking housing and heat sink provides scalability with superior structural rigidity. 3G vibration tested and rated. Optional tool-less hardware available for ease of entry into electrical chamber. Housing is IP66 rated.

Optics

Patented, high-efficiency injection-molded AccuLED Optics technology. Optics are precisely designed to shape the distribution maximizing efficiency and application spacing. AccuLED Optics create consistent distributions with the scalability to meet customized application requirements. Offered standard in 4000K (+/- 275K) CCT 70 CRI. Optional 3000K, 5000K and 6000K CCT.

Electrical

LED drivers are mounted to removable tray assembly for ease of maintenance. 120-277V 50/60Hz, 347V 60Hz or 480V 60Hz operation. 480V is compatible for use with 480V Wye systems only. Standard with 0-10V dimming. Shipped standard with Eaton proprietary circuit module designed to withstand 10kV of transient line surge. The Galleon LED luminaire is suitable for operation in -40°C to 40°C ambient environments. For applications with ambient temperatures exceeding 40°C, specify the HA (High Ambient) option. Light Squares are IP66 rated. Greater than 90% lumen maintenance expected at 60,000 hours. Available in standard 1A drive current and optional 600mA, 800mA and 1200mA drive currents (nominal).

Mounting

STANDARD ARM MOUNT: Extruded aluminum arm includes internal bolt guides allowing for easy positioning of fixture during mounting. When mounting two or more luminaires at 90° and 120° apart, the EA extended arm may be required. Refer to the

arm mounting requirement table. Round pole adapter included. For wall mounting, specify wall mount bracket option. **QUICK MOUNT ARM:** Adapter is bolted directly to the pole. Quick mount arm slide into place on the adapter and is secured via two screws, facilitating quick and easy installation. The versatile, patent pending, quick mount arm accommodates multiple drill patterns ranging from 1-1/2" to 4-7/8". Removal of the door on the quick mount arm enables wiring of the fixture without having to access the driver compartment. A knock-out enables round pole mounting.

Finish

Housing finished in super durable TGIC polyester powder coat paint, 2.5 mil nominal thickness for superior protection against fade and wear. Heat sink is powder coated black. Standard housing colors include black, bronze, grey, white, dark platinum and graphite metallic. RAL and custom color matches available.

Warranty

Five-year warranty.



GLEON GALLEON LED

1-10 Light Squares
Solid State LED

AREA/SITE LUMINAIRE

DIMENSIONS

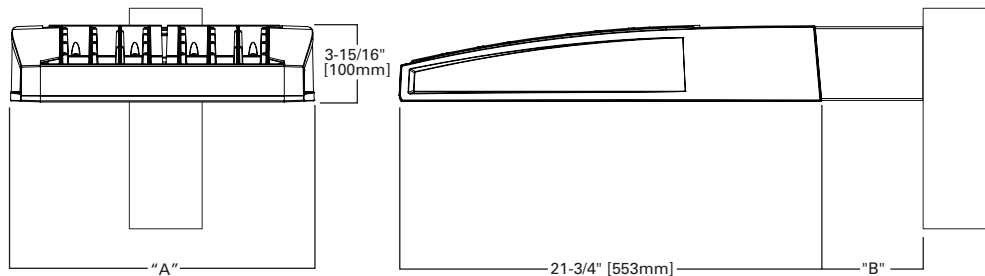

DIMENSION DATA

| Number of Light Squares | "A" Width | "B" Standard Arm Length | "B" Optional Arm Length ¹ | Weight with Arm (lbs.) | EPA with Arm ² (Sq. Ft.) |
|-------------------------|-----------------|-------------------------|--------------------------------------|------------------------|-------------------------------------|
| 1-4 | 15-1/2" (394mm) | 7" (178mm) | 10" (254mm) | 33 (15.0 kgs.) | 0.96 |
| 5-6 | 21-5/8" (549mm) | 7" (178mm) | 10" (254mm) | 44 (20.0 kgs.) | 1.00 |
| 7-8 | 27-5/8" (702mm) | 7" (178mm) | 13" (330mm) | 54 (24.5 kgs.) | 1.07 |
| 9-10 | 33-3/4" (857mm) | 7" (178mm) | 16" (406mm) | 63 (28.6 kgs.) | 1.12 |

NOTES: 1. Optional arm length to be used when mounting two fixtures at 90° on a single pole. 2. EPA calculated with optional arm length.

DRILLING PATTERN

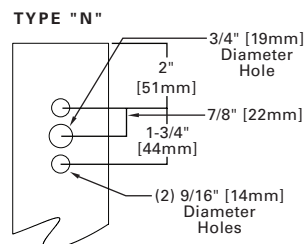

CERTIFICATION DATA

UL/cUL Wet Location Listed
ISO 9001
LM79 / LM80 Compliant
3G Vibration Rated
IP66 Rated
DesignLights Consortium® Qualified*

ENERGY DATA

Electronic LED Driver
>0.9 Power Factor
<20% Total Harmonic Distortion
120V-277V 50/60Hz
347V & 480V 60Hz
-40°C Min. Temperature
40°C Max. Temperature
50°C Max. Temperature (HA Option)

ARM MOUNTING REQUIREMENTS

| Configuration | 90° Apart | 120° Apart |
|---------------|-----------------------------|-----------------------------|
| GLEON-AF-01 | 7" Arm (Standard) | 7" Arm (Standard) |
| GLEON-AF-02 | 7" Arm (Standard) | 7" Arm (Standard) |
| GLEON-AF-03 | 7" Arm (Standard) | 7" Arm (Standard) |
| GLEON-AF-04 | 7" Arm (Standard) | 7" Arm (Standard) |
| GLEON-AF-05 | 10" Extended Arm (Required) | 7" Arm (Standard) |
| GLEON-AF-06 | 10" Extended Arm (Required) | 7" Arm (Standard) |
| GLEON-AF-07 | 13" Extended Arm (Required) | 13" Extended Arm (Required) |
| GLEON-AF-08 | 13" Extended Arm (Required) | 13" Extended Arm (Required) |
| GLEON-AF-09 | 16" Extended Arm (Required) | 16" Extended Arm (Required) |
| GLEON-AF-10 | 16" Extended Arm (Required) | 16" Extended Arm (Required) |

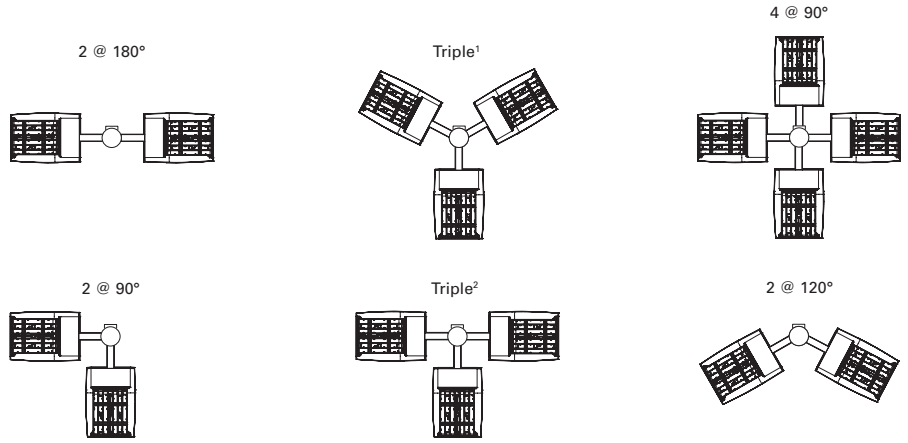

NOTES: 1 Round poles are 3 @ 120°. Square poles are 3 @ 90°. 2 Round poles are 3 @ 90°.

STANDARD WALL MOUNT

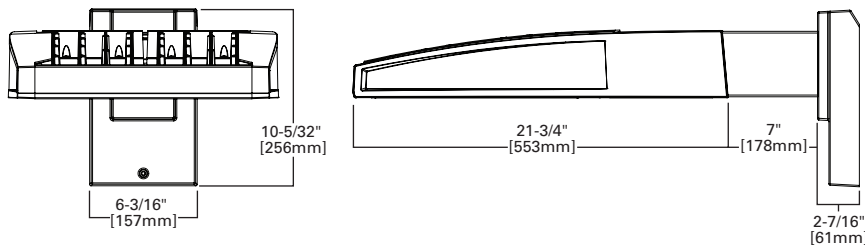

MAST ARM MOUNT

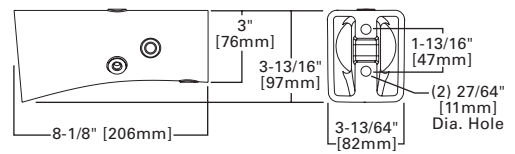

QUICK MOUNT ARM (INCLUDES FIXTURE ADAPTER)

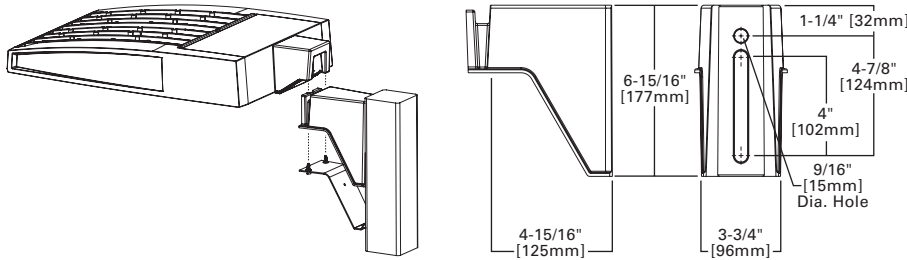

QM Quick Mount Arm (Standard)

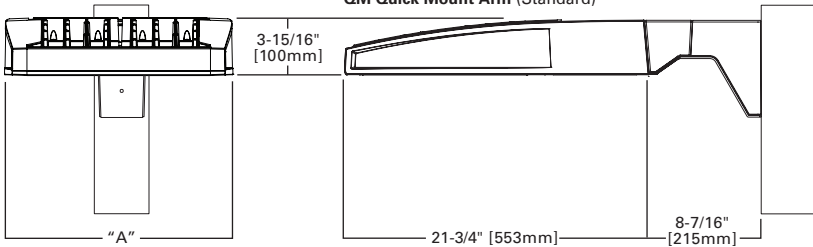

QMEA Quick Mount Arm (Extended)

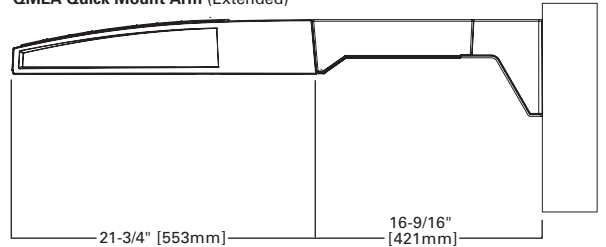

QUICK MOUNT ARM DATA

| Number of Light Squares ^{1,2} | "A" Width | Weight with QM Arm (lbs.) | Weight with QMEA Arm (lbs.) | EPA (Sq. Ft.) |
|--|-----------------|---------------------------|-----------------------------|---------------|
| 1-4 | 15-1/2" (394mm) | 35 (15.91 kgs.) | 38 (17.27 kgs.) | 1.11 |
| 5-6 ³ | 21-5/8" (549mm) | 46 (20.91 kgs.) | 49 (22.27 kgs.) | |
| 7-8 | 27-5/8" (702mm) | 56 (25.45 kgs.) | 59 (26.82 kgs.) | |

NOTES: 1 QM option available with 1-8 light square configurations. 2 QMEA option available with 1-6 light square configurations. 3 QMEA arm to be used when mounting two fixtures at 90° on a single pole.

OPTIC ORIENTATION

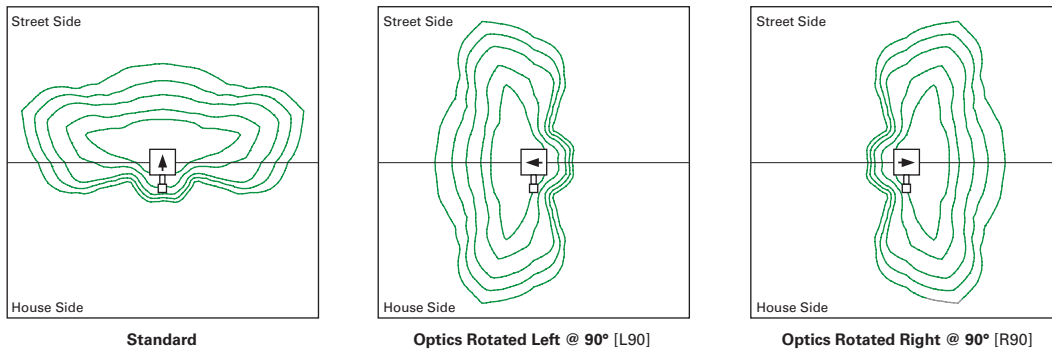

OPTICAL DISTRIBUTIONS

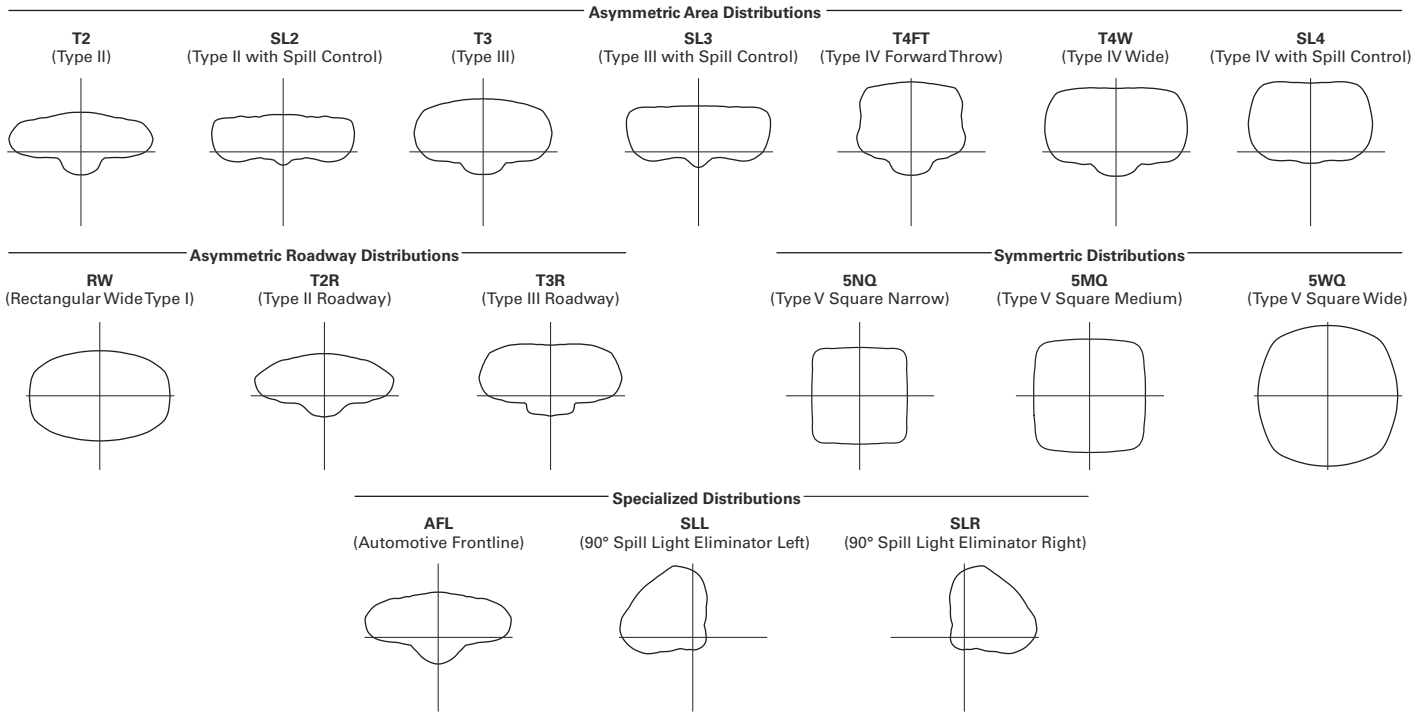

LUMEN MAINTENANCE

| Drive Current | Ambient Temperature | TM-21 Lumen Maintenance (60,000 Hours) | Projected L70 (Hours) |
|---------------|---------------------|--|-----------------------|
| Up to 1A | Up to 50°C | > 95% | 416,000 |
| 1.2A | Up to 40°C | > 90% | 205,000 |

LUMEN MULTIPLIER

| Ambient Temperature | Lumen Multiplier |
|---------------------|------------------|
| 0°C | 1.02 |
| 10°C | 1.01 |
| 25°C | 1.00 |
| 40°C | 0.99 |
| 50°C | 0.97 |

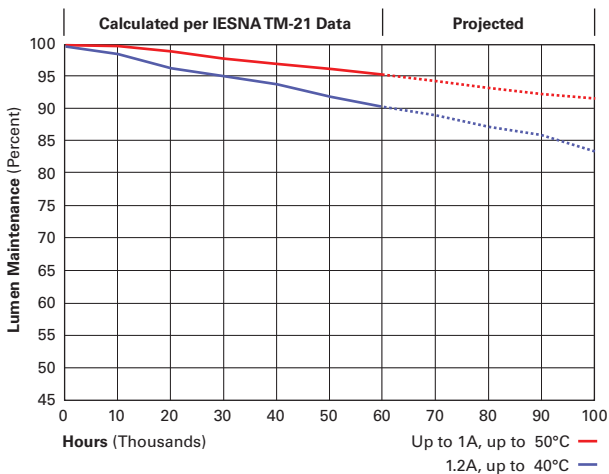

NOMINAL POWER LUMENS (1.2A)

| Number of Light Squares | 1 | 2 | 3 | 4 | 5 | 6 | 7 | 8 | 9 | 10 | |
|---------------------------------|--------------------|----------|----------|----------|----------|----------|----------|----------|----------|----------|----------|
| Nominal Power (Watts) | 67 | 129 | 191 | 258 | 320 | 382 | 448 | 511 | 575 | 640 | |
| Input Current @ 120V (A) | 0.58 | 1.16 | 1.78 | 2.31 | 2.94 | 3.56 | 4.09 | 4.71 | 5.34 | 5.87 | |
| Input Current @ 208V (A) | 0.33 | 0.63 | 0.93 | 1.27 | 1.57 | 1.87 | 2.22 | 2.52 | 2.8 | 3.14 | |
| Input Current @ 240V (A) | 0.29 | 0.55 | 0.80 | 1.10 | 1.35 | 1.61 | 1.93 | 2.18 | 2.41 | 2.71 | |
| Input Current @ 277V (A) | 0.25 | 0.48 | 0.70 | 0.96 | 1.18 | 1.39 | 1.69 | 1.90 | 2.09 | 2.36 | |
| Input Current @ 347V (A) | 0.20 | 0.39 | 0.57 | 0.78 | 0.96 | 1.15 | 1.36 | 1.54 | 1.72 | 1.92 | |
| Input Current @ 480V (A) | 0.15 | 0.30 | 0.43 | 0.60 | 0.73 | 0.85 | 1.03 | 1.16 | 1.28 | 1.45 | |
| Optics | | | | | | | | | | | |
| T2 | 4000K/5000K Lumens | 6,709 | 13,111 | 19,562 | 25,848 | 32,026 | 38,325 | 45,324 | 51,355 | 57,286 | 63,424 |
| | 3000K Lumens | 5,939 | 11,606 | 17,316 | 22,881 | 28,349 | 33,925 | 40,121 | 45,459 | 50,710 | 56,143 |
| | BUG Rating | B1-U0-G2 | B2-U0-G2 | B3-U0-G3 | B3-U0-G4 | B3-U0-G4 | B3-U0-G5 | B4-U0-G5 | B4-U0-G5 | B4-U0-G5 | B4-U0-G5 |
| T2R | 4000K/5000K Lumens | 7,122 | 13,919 | 20,769 | 27,442 | 34,000 | 40,687 | 48,117 | 54,519 | 60,816 | 67,333 |
| | 3000K Lumens | 5,939 | 11,606 | 17,316 | 22,881 | 28,349 | 33,925 | 40,121 | 45,459 | 50,710 | 56,143 |
| | BUG Rating | B1-U0-G1 | B2-U0-G2 | B2-U0-G3 | B3-U0-G3 | B3-U0-G4 | B3-U0-G4 | B3-U0-G5 | B3-U0-G5 | B4-U0-G5 | B4-U0-G5 |
| T3 | 4000K/5000K Lumens | 6,838 | 13,363 | 19,939 | 26,346 | 32,642 | 39,062 | 46,196 | 52,343 | 58,388 | 64,646 |
| | 3000K Lumens | 6,053 | 11,829 | 17,650 | 23,321 | 28,895 | 34,578 | 40,893 | 46,334 | 51,685 | 57,225 |
| | BUG Rating | B1-U0-G2 | B2-U0-G2 | B3-U0-G3 | B3-U0-G4 | B3-U0-G4 | B3-U0-G5 | B4-U0-G5 | B4-U0-G5 | B4-U0-G5 | B4-U0-G5 |
| T3R | 4000K/5000K Lumens | 6,990 | 13,660 | 20,382 | 26,931 | 33,368 | 39,930 | 47,223 | 53,506 | 59,686 | 66,081 |
| | 3000K Lumens | 6,188 | 12,092 | 18,042 | 23,839 | 29,537 | 35,346 | 41,802 | 47,364 | 52,834 | 58,495 |
| | BUG Rating | B1-U0-G2 | B2-U0-G3 | B2-U0-G3 | B3-U0-G4 | B3-U0-G5 | B3-U0-G5 | B3-U0-G5 | B3-U0-G5 | B4-U0-G5 | B4-U0-G5 |
| T4FT | 4000K/5000K Lumens | 6,878 | 13,440 | 20,055 | 26,499 | 32,832 | 39,289 | 46,464 | 52,646 | 58,726 | 65,020 |
| | 3000K Lumens | 6,088 | 11,897 | 17,753 | 23,457 | 29,063 | 34,779 | 41,130 | 46,602 | 51,984 | 57,556 |
| | BUG Rating | B1-U0-G2 | B2-U0-G3 | B2-U0-G4 | B3-U0-G4 | B3-U0-G5 | B3-U0-G5 | B3-U0-G5 | B4-U0-G5 | B4-U0-G5 | B4-U0-G5 |
| T4W | 4000K/5000K Lumens | 6,789 | 13,267 | 19,795 | 26,156 | 32,408 | 38,781 | 45,864 | 51,967 | 57,968 | 64,180 |
| | 3000K Lumens | 6,010 | 11,744 | 17,523 | 23,153 | 28,688 | 34,329 | 40,599 | 46,001 | 51,313 | 56,812 |
| | BUG Rating | B1-U0-G2 | B2-U0-G3 | B3-U0-G4 | B3-U0-G4 | B3-U0-G5 | B3-U0-G5 | B4-U0-G5 | B4-U0-G5 | B4-U0-G5 | B4-U0-G5 |
| SL2 | 4000K/5000K Lumens | 6,697 | 13,088 | 19,529 | 25,804 | 31,970 | 38,259 | 45,245 | 51,267 | 57,186 | 63,315 |
| | 3000K Lumens | 5,928 | 11,585 | 17,287 | 22,842 | 28,300 | 33,867 | 40,051 | 45,382 | 50,621 | 56,046 |
| | BUG Rating | B1-U0-G2 | B2-U0-G3 | B3-U0-G3 | B3-U0-G4 | B3-U0-G4 | B3-U0-G5 | B4-U0-G5 | B4-U0-G5 | B4-U0-G5 | B4-U0-G5 |
| SL3 | 4000K/5000K Lumens | 6,837 | 13,361 | 19,936 | 26,342 | 32,639 | 39,057 | 46,189 | 52,336 | 58,380 | 64,636 |
| | 3000K Lumens | 6,052 | 11,827 | 17,647 | 23,318 | 28,892 | 34,573 | 40,887 | 46,328 | 51,678 | 57,216 |
| | BUG Rating | B1-U0-G2 | B2-U0-G3 | B2-U0-G4 | B3-U0-G4 | B3-U0-G5 | B3-U0-G5 | B3-U0-G5 | B4-U0-G5 | B4-U0-G5 | B4-U0-G5 |
| SL4 | 4000K/5000K Lumens | 6,496 | 12,695 | 18,943 | 25,029 | 31,011 | 37,110 | 43,886 | 49,727 | 55,470 | 61,414 |
| | 3000K Lumens | 5,750 | 11,238 | 16,768 | 22,156 | 27,451 | 32,850 | 38,848 | 44,018 | 49,102 | 54,364 |
| | BUG Rating | B1-U0-G2 | B1-U0-G3 | B2-U0-G4 | B2-U0-G4 | B2-U0-G5 | B3-U0-G5 | B3-U0-G5 | B3-U0-G5 | B3-U0-G5 | B3-U0-G5 |
| 5NQ | 4000K/5000K Lumens | 7,052 | 13,781 | 20,564 | 27,171 | 33,664 | 40,285 | 47,641 | 53,981 | 60,215 | 66,669 |
| | 3000K Lumens | 6,242 | 12,199 | 18,203 | 24,052 | 29,799 | 35,660 | 42,172 | 47,784 | 53,302 | 59,015 |
| | BUG Rating | B3-U0-G1 | B3-U0-G2 | B4-U0-G2 | B4-U0-G2 | B5-U0-G2 | B5-U0-G3 | B5-U0-G3 | B5-U0-G4 | B5-U0-G4 | B5-U0-G4 |
| 5MQ | 4000K/5000K Lumens | 7,182 | 14,034 | 20,942 | 27,671 | 34,284 | 41,027 | 48,518 | 54,975 | 61,323 | 67,896 |
| | 3000K Lumens | 6,358 | 12,423 | 18,538 | 24,494 | 30,348 | 36,317 | 42,948 | 48,664 | 54,283 | 60,102 |
| | BUG Rating | B3-U0-G1 | B4-U0-G2 | B4-U0-G2 | B5-U0-G3 | B5-U0-G4 | B5-U0-G4 | B5-U0-G4 | B5-U0-G5 | B5-U0-G5 | B5-U0-G5 |
| 5WQ | 4000K/5000K Lumens | 7,201 | 14,073 | 20,998 | 27,744 | 34,375 | 41,136 | 48,648 | 55,121 | 61,487 | 68,077 |
| | 3000K Lumens | 6,374 | 12,457 | 18,587 | 24,559 | 30,429 | 36,414 | 43,063 | 48,793 | 54,428 | 60,262 |
| | BUG Rating | B3-U0-G2 | B4-U0-G2 | B5-U0-G3 | B5-U0-G4 | B5-U0-G4 | B5-U0-G4 | B5-U0-G5 | B5-U0-G5 | B5-U0-G5 | B5-U0-G5 |
| SLL/SLR | 4000K/5000K Lumens | 6,009 | 11,741 | 17,519 | 23,148 | 28,681 | 34,321 | 40,589 | 45,990 | 51,301 | 56,798 |
| | 3000K Lumens | 5,319 | 10,393 | 15,508 | 20,491 | 25,388 | 30,381 | 35,929 | 40,710 | 45,412 | 50,278 |
| | BUG Rating | B1-U0-G2 | B2-U0-G3 | B2-U0-G3 | B3-U0-G4 | B3-U0-G4 | B3-U0-G5 | B3-U0-G5 | B3-U0-G5 | B3-U0-G5 | B4-U0-G5 |
| RW | 4000K/5000K Lumens | 6,989 | 13,657 | 20,378 | 26,925 | 33,360 | 39,921 | 47,211 | 53,494 | 59,672 | 66,066 |
| | 3000K Lumens | 6,187 | 12,089 | 18,039 | 23,834 | 29,530 | 35,338 | 41,791 | 47,353 | 52,822 | 58,482 |
| | BUG Rating | B3-U0-G1 | B3-U0-G2 | B4-U0-G2 | B4-U0-G2 | B5-U0-G3 | B5-U0-G3 | B5-U0-G4 | B5-U0-G4 | B5-U0-G4 | B5-U0-G4 |
| AFL | 4000K/5000K Lumens | 7,014 | 13,706 | 20,452 | 27,023 | 33,481 | 40,066 | 47,383 | 53,688 | 59,888 | 66,306 |
| | 3000K Lumens | 6,209 | 12,133 | 18,104 | 23,921 | 29,637 | 35,466 | 41,943 | 47,525 | 53,013 | 58,694 |
| | BUG Rating | B1-U0-G1 | B2-U0-G2 | B2-U0-G2 | B3-U0-G3 | B3-U0-G3 | B3-U0-G3 | B3-U0-G3 | B3-U0-G4 | B4-U0-G4 | B4-U0-G4 |

* Nominal data for 70 CRI.

NOMINAL POWER LUMENS (1A)

| Number of Light Squares | 1 | 2 | 3 | 4 | 5 | 6 | 7 | 8 | 9 | 10 | |
|---------------------------------|--------------------|----------|----------|----------|----------|----------|----------|----------|----------|----------|----------|
| Nominal Power (Watts) | 59 | 113 | 166 | 225 | 279 | 333 | 391 | 445 | 501 | 558 | |
| Input Current @ 120V (A) | 0.51 | 1.02 | 1.53 | 2.03 | 2.55 | 3.06 | 3.56 | 4.08 | 4.6 | 5.07 | |
| Input Current @ 208V (A) | 0.29 | 0.56 | 0.82 | 1.11 | 1.37 | 1.64 | 1.93 | 2.19 | 2.46 | 2.75 | |
| Input Current @ 240V (A) | 0.26 | 0.48 | 0.71 | 0.96 | 1.19 | 1.41 | 1.67 | 1.89 | 2.12 | 2.39 | |
| Input Current @ 277V (A) | 0.23 | 0.42 | 0.61 | 0.83 | 1.03 | 1.23 | 1.45 | 1.65 | 1.84 | 2.09 | |
| Input Current @ 347V (A) | 0.17 | 0.32 | 0.50 | 0.64 | 0.82 | 1.00 | 1.14 | 1.32 | 1.50 | 1.68 | |
| Input Current @ 480V (A) | 0.14 | 0.24 | 0.37 | 0.48 | 0.61 | 0.75 | 0.91 | 0.99 | 1.12 | 1.28 | |
| Optics | | | | | | | | | | | |
| T2 | 4000K/5000K Lumens | 6,116 | 11,951 | 17,833 | 23,563 | 29,195 | 34,937 | 41,317 | 46,814 | 52,221 | 57,817 |
| | 3000K Lumens | 5,414 | 10,579 | 15,786 | 20,858 | 25,843 | 30,926 | 36,574 | 41,440 | 46,226 | 51,180 |
| | BUG Rating | B1-U0-G2 | B2-U0-G2 | B3-U0-G3 | B3-U0-G3 | B3-U0-G4 | B3-U0-G4 | B4-U0-G5 | B4-U0-G5 | B4-U0-G5 | B4-U0-G5 |
| T2R | 4000K/5000K Lumens | 6,493 | 12,688 | 18,932 | 25,015 | 30,994 | 37,090 | 43,863 | 49,699 | 55,439 | 61,380 |
| | 3000K Lumens | 5,748 | 11,231 | 16,759 | 22,143 | 27,436 | 32,832 | 38,828 | 43,994 | 49,075 | 54,334 |
| | BUG Rating | B1-U0-G1 | B2-U0-G2 | B2-U0-G2 | B3-U0-G3 | B3-U0-G4 | B3-U0-G4 | B3-U0-G4 | B3-U0-G5 | B4-U0-G5 | B4-U0-G5 |
| T3 | 4000K/5000K Lumens | 6,234 | 12,181 | 18,176 | 24,017 | 29,756 | 35,609 | 42,111 | 47,715 | 53,225 | 58,930 |
| | 3000K Lumens | 5,518 | 10,783 | 16,089 | 21,260 | 26,340 | 31,521 | 37,277 | 42,237 | 47,115 | 52,165 |
| | BUG Rating | B1-U0-G2 | B2-U0-G2 | B3-U0-G3 | B3-U0-G4 | B3-U0-G4 | B3-U0-G5 | B4-U0-G5 | B4-U0-G5 | B4-U0-G5 | B4-U0-G5 |
| T3R | 4000K/5000K Lumens | 6,372 | 12,453 | 18,580 | 24,550 | 30,418 | 36,400 | 43,048 | 48,776 | 54,409 | 60,239 |
| | 3000K Lumens | 5,640 | 11,023 | 16,447 | 21,732 | 26,926 | 32,221 | 38,106 | 43,177 | 48,163 | 53,324 |
| | BUG Rating | B1-U0-G2 | B2-U0-G2 | B2-U0-G3 | B3-U0-G4 | B3-U0-G4 | B3-U0-G5 | B3-U0-G5 | B3-U0-G5 | B3-U0-G5 | B4-U0-G5 |
| T4FT | 4000K/5000K Lumens | 6,270 | 12,252 | 18,282 | 24,156 | 29,929 | 35,815 | 42,356 | 47,992 | 53,534 | 59,271 |
| | 3000K Lumens | 5,550 | 10,845 | 16,183 | 21,383 | 26,493 | 31,703 | 37,494 | 42,483 | 47,388 | 52,467 |
| | BUG Rating | B1-U0-G2 | B2-U0-G2 | B2-U0-G3 | B3-U0-G4 | B3-U0-G5 | B3-U0-G5 | B3-U0-G5 | B3-U0-G5 | B4-U0-G5 | B4-U0-G5 |
| T4W | 4000K/5000K Lumens | 6,189 | 12,094 | 18,045 | 23,844 | 29,543 | 35,352 | 41,809 | 47,372 | 52,843 | 58,506 |
| | 3000K Lumens | 5,479 | 10,706 | 15,973 | 21,107 | 26,151 | 31,294 | 37,009 | 41,934 | 46,777 | 51,790 |
| | BUG Rating | B1-U0-G2 | B2-U0-G2 | B3-U0-G3 | B3-U0-G4 | B3-U0-G5 | B3-U0-G5 | B4-U0-G5 | B4-U0-G5 | B4-U0-G5 | B4-U0-G5 |
| SL2 | 4000K/5000K Lumens | 6,105 | 11,931 | 17,803 | 23,522 | 29,144 | 34,877 | 41,245 | 46,734 | 52,130 | 57,717 |
| | 3000K Lumens | 5,404 | 10,561 | 15,759 | 20,822 | 25,798 | 30,873 | 36,510 | 41,369 | 46,145 | 51,091 |
| | BUG Rating | B1-U0-G2 | B2-U0-G3 | B3-U0-G3 | B3-U0-G4 | B3-U0-G4 | B3-U0-G5 | B4-U0-G5 | B4-U0-G5 | B4-U0-G5 | B4-U0-G5 |
| SL3 | 4000K/5000K Lumens | 6,233 | 12,180 | 18,174 | 24,013 | 29,753 | 35,604 | 42,106 | 47,708 | 53,218 | 58,921 |
| | 3000K Lumens | 5,517 | 10,782 | 16,088 | 21,256 | 26,337 | 31,517 | 37,272 | 42,231 | 47,109 | 52,157 |
| | BUG Rating | B1-U0-G2 | B2-U0-G3 | B2-U0-G3 | B3-U0-G4 | B3-U0-G4 | B3-U0-G5 | B3-U0-G5 | B3-U0-G5 | B4-U0-G5 | B4-U0-G5 |
| SL4 | 4000K/5000K Lumens | 5,922 | 11,572 | 17,268 | 22,816 | 28,269 | 33,829 | 40,006 | 45,330 | 50,566 | 55,984 |
| | 3000K Lumens | 5,242 | 10,244 | 15,286 | 20,197 | 25,024 | 29,945 | 35,413 | 40,126 | 44,761 | 49,557 |
| | BUG Rating | B1-U0-G2 | B1-U0-G3 | B2-U0-G3 | B2-U0-G4 | B2-U0-G5 | B3-U0-G5 | B3-U0-G5 | B3-U0-G5 | B3-U0-G5 | B3-U0-G5 |
| 5NQ | 4000K/5000K Lumens | 6,429 | 12,563 | 18,746 | 24,768 | 30,688 | 36,723 | 43,429 | 49,208 | 54,891 | 60,775 |
| | 3000K Lumens | 5,691 | 11,121 | 16,594 | 21,925 | 27,165 | 32,507 | 38,443 | 43,559 | 48,590 | 53,798 |
| | BUG Rating | B2-U0-G1 | B3-U0-G2 | B4-U0-G2 | B4-U0-G2 | B5-U0-G2 | B5-U0-G3 | B5-U0-G3 | B5-U0-G3 | B5-U0-G4 | B5-U0-G4 |
| 5MQ | 4000K/5000K Lumens | 6,547 | 12,794 | 19,090 | 25,224 | 31,253 | 37,400 | 44,228 | 50,114 | 55,902 | 61,893 |
| | 3000K Lumens | 5,795 | 11,325 | 16,898 | 22,328 | 27,665 | 33,106 | 39,151 | 44,361 | 49,484 | 54,788 |
| | BUG Rating | B3-U0-G1 | B4-U0-G2 | B4-U0-G2 | B5-U0-G3 | B5-U0-G3 | B5-U0-G4 | B5-U0-G4 | B5-U0-G4 | B5-U0-G5 | B5-U0-G5 |
| 5WQ | 4000K/5000K Lumens | 6,564 | 12,828 | 19,141 | 25,291 | 31,336 | 37,499 | 44,347 | 50,248 | 56,051 | 62,058 |
| | 3000K Lumens | 5,810 | 11,355 | 16,944 | 22,388 | 27,739 | 33,194 | 39,256 | 44,480 | 49,616 | 54,934 |
| | BUG Rating | B3-U0-G2 | B4-U0-G2 | B5-U0-G3 | B5-U0-G3 | B5-U0-G4 | B5-U0-G4 | B5-U0-G5 | B5-U0-G5 | B5-U0-G5 | B5-U0-G5 |
| SLL/SLR | 4000K/5000K Lumens | 5,478 | 10,703 | 15,970 | 21,102 | 26,145 | 31,286 | 37,001 | 41,924 | 46,765 | 51,777 |
| | 3000K Lumens | 4,849 | 9,474 | 14,137 | 18,679 | 23,144 | 27,694 | 32,753 | 37,111 | 41,396 | 45,833 |
| | BUG Rating | B1-U0-G2 | B1-U0-G3 | B2-U0-G3 | B2-U0-G4 | B3-U0-G4 | B3-U0-G5 | B3-U0-G5 | B3-U0-G5 | B3-U0-G5 | B3-U0-G5 |
| RW | 4000K/5000K Lumens | 6,371 | 12,449 | 18,576 | 24,544 | 30,411 | 36,392 | 43,037 | 48,764 | 54,396 | 60,225 |
| | 3000K Lumens | 5,640 | 11,020 | 16,443 | 21,726 | 26,920 | 32,214 | 38,096 | 43,166 | 48,151 | 53,311 |
| | BUG Rating | B3-U0-G1 | B3-U0-G2 | B4-U0-G2 | B4-U0-G2 | B5-U0-G3 | B5-U0-G3 | B5-U0-G3 | B5-U0-G4 | B5-U0-G4 | B5-U0-G4 |
| AFL | 4000K/5000K Lumens | 6,394 | 12,494 | 18,644 | 24,634 | 30,521 | 36,524 | 43,194 | 48,942 | 54,593 | 60,444 |
| | 3000K Lumens | 5,660 | 11,060 | 16,504 | 21,806 | 27,017 | 32,331 | 38,235 | 43,323 | 48,326 | 53,505 |
| | BUG Rating | B1-U0-G1 | B2-U0-G2 | B2-U0-G2 | B3-U0-G2 | B3-U0-G3 | B3-U0-G3 | B3-U0-G3 | B3-U0-G3 | B4-U0-G4 | B4-U0-G4 |

* Nominal data for 70 CRI.

NOMINAL POWER LUMENS (800MA)

| Number of Light Squares | 1 | 2 | 3 | 4 | 5 | 6 | 7 | 8 | 9 | 10 | |
|---------------------------------|--------------------|----------|----------|----------|----------|----------|----------|----------|----------|----------|----------|
| Nominal Power (Watts) | 44 | 85 | 124 | 171 | 210 | 249 | 295 | 334 | 374 | 419 | |
| Input Current @ 120V (A) | 0.39 | 0.77 | 1.13 | 1.54 | 1.90 | 2.26 | 2.67 | 3.03 | 3.39 | 3.80 | |
| Input Current @ 208V (A) | 0.22 | 0.44 | 0.62 | 0.88 | 1.06 | 1.24 | 1.50 | 1.68 | 1.87 | 2.12 | |
| Input Current @ 240V (A) | 0.19 | 0.38 | 0.54 | 0.76 | 0.92 | 1.08 | 1.30 | 1.46 | 1.62 | 1.84 | |
| Input Current @ 277V (A) | 0.17 | 0.36 | 0.47 | 0.72 | 0.83 | 0.95 | 1.19 | 1.31 | 1.42 | 1.67 | |
| Input Current @ 347V (A) | 0.15 | 0.24 | 0.38 | 0.49 | 0.63 | 0.77 | 0.87 | 1.01 | 1.15 | 1.52 | |
| Input Current @ 480V (A) | 0.11 | 0.18 | 0.29 | 0.37 | 0.48 | 0.59 | 0.66 | 0.77 | 0.88 | 0.96 | |
| Optics | | | | | | | | | | | |
| T2 | 4000K/5000K Lumens | 4,941 | 9,656 | 14,408 | 19,038 | 23,588 | 28,227 | 33,382 | 37,823 | 42,191 | 46,713 |
| | 3000K Lumens | 4,374 | 8,547 | 12,754 | 16,852 | 20,880 | 24,987 | 29,550 | 33,481 | 37,347 | 41,350 |
| | BUG Rating | B1-U0-G1 | B2-U0-G2 | B2-U0-G2 | B3-U0-G3 | B3-U0-G3 | B3-U0-G4 | B3-U0-G4 | B3-U0-G4 | B4-U0-G5 | B4-U0-G5 |
| T2R | 4000K/5000K Lumens | 5,246 | 10,251 | 15,296 | 20,211 | 25,041 | 29,966 | 35,439 | 40,154 | 44,791 | 49,592 |
| | 3000K Lumens | 4,644 | 9,074 | 13,540 | 17,891 | 22,166 | 26,526 | 31,371 | 35,544 | 39,649 | 43,899 |
| | BUG Rating | B1-U0-G1 | B1-U0-G2 | B2-U0-G2 | B2-U0-G3 | B3-U0-G3 | B3-U0-G4 | B3-U0-G4 | B3-U0-G4 | B3-U0-G4 | B3-U0-G5 |
| T3 | 4000K/5000K Lumens | 5,037 | 9,842 | 14,685 | 19,404 | 24,041 | 28,770 | 34,024 | 38,551 | 43,003 | 47,612 |
| | 3000K Lumens | 4,459 | 8,712 | 12,999 | 17,176 | 21,281 | 25,467 | 30,118 | 34,125 | 38,066 | 42,146 |
| | BUG Rating | B1-U0-G1 | B2-U0-G2 | B2-U0-G3 | B3-U0-G3 | B3-U0-G4 | B3-U0-G4 | B3-U0-G4 | B3-U0-G5 | B4-U0-G5 | B4-U0-G5 |
| T3R | 4000K/5000K Lumens | 5,148 | 10,061 | 15,011 | 19,835 | 24,576 | 29,409 | 34,780 | 39,408 | 43,959 | 48,669 |
| | 3000K Lumens | 4,557 | 8,906 | 13,288 | 17,558 | 21,755 | 26,033 | 30,787 | 34,884 | 38,913 | 43,082 |
| | BUG Rating | B1-U0-G2 | B1-U0-G2 | B2-U0-G3 | B2-U0-G3 | B3-U0-G4 | B3-U0-G4 | B3-U0-G5 | B3-U0-G5 | B3-U0-G5 | B3-U0-G5 |
| T4FT | 4000K/5000K Lumens | 5,066 | 9,899 | 14,770 | 19,516 | 24,181 | 28,936 | 34,221 | 38,774 | 43,252 | 47,888 |
| | 3000K Lumens | 4,484 | 8,763 | 13,074 | 17,276 | 21,405 | 25,614 | 30,292 | 34,323 | 38,287 | 42,390 |
| | BUG Rating | B1-U0-G2 | B1-U0-G2 | B2-U0-G3 | B2-U0-G4 | B3-U0-G4 | B3-U0-G4 | B3-U0-G5 | B3-U0-G5 | B3-U0-G5 | B3-U0-G5 |
| T4W | 4000K/5000K Lumens | 5,000 | 9,771 | 14,579 | 19,264 | 23,869 | 28,562 | 33,779 | 38,274 | 42,694 | 47,269 |
| | 3000K Lumens | 4,426 | 8,649 | 12,905 | 17,052 | 21,129 | 25,283 | 29,901 | 33,880 | 37,793 | 41,843 |
| | BUG Rating | B1-U0-G2 | B2-U0-G2 | B2-U0-G3 | B3-U0-G4 | B3-U0-G4 | B3-U0-G4 | B3-U0-G5 | B3-U0-G5 | B4-U0-G5 | B4-U0-G5 |
| SL2 | 4000K/5000K Lumens | 4,933 | 9,639 | 14,383 | 19,005 | 23,547 | 28,178 | 33,324 | 37,758 | 42,118 | 46,632 |
| | 3000K Lumens | 4,367 | 8,532 | 12,732 | 16,823 | 20,844 | 24,943 | 29,498 | 33,423 | 37,283 | 41,279 |
| | BUG Rating | B1-U0-G2 | B2-U0-G2 | B2-U0-G3 | B3-U0-G3 | B3-U0-G4 | B3-U0-G4 | B3-U0-G4 | B3-U0-G5 | B4-U0-G5 | B4-U0-G5 |
| SL3 | 4000K/5000K Lumens | 5,036 | 9,841 | 14,683 | 19,401 | 24,039 | 28,766 | 34,019 | 38,546 | 42,997 | 47,605 |
| | 3000K Lumens | 4,458 | 8,711 | 12,997 | 17,174 | 21,279 | 25,464 | 30,114 | 34,121 | 38,061 | 42,140 |
| | BUG Rating | B1-U0-G2 | B1-U0-G2 | B2-U0-G3 | B2-U0-G3 | B3-U0-G4 | B3-U0-G4 | B3-U0-G5 | B3-U0-G5 | B3-U0-G5 | B3-U0-G5 |
| SL4 | 4000K/5000K Lumens | 4,784 | 9,350 | 13,951 | 18,434 | 22,840 | 27,332 | 32,323 | 36,624 | 40,854 | 45,232 |
| | 3000K Lumens | 4,235 | 8,277 | 12,349 | 16,318 | 20,218 | 24,194 | 28,612 | 32,420 | 36,164 | 40,039 |
| | BUG Rating | B1-U0-G2 | B1-U0-G3 | B1-U0-G3 | B2-U0-G4 | B2-U0-G4 | B2-U0-G5 | B2-U0-G5 | B3-U0-G5 | B3-U0-G5 | B3-U0-G5 |
| 5NQ | 4000K/5000K Lumens | 5,194 | 10,150 | 15,145 | 20,011 | 24,794 | 29,670 | 35,088 | 39,757 | 44,349 | 49,102 |
| | 3000K Lumens | 4,598 | 8,985 | 13,406 | 17,714 | 21,948 | 26,264 | 31,060 | 35,193 | 39,258 | 43,465 |
| | BUG Rating | B2-U0-G1 | B3-U0-G1 | B3-U0-G2 | B4-U0-G2 | B4-U0-G2 | B5-U0-G2 | B5-U0-G3 | B5-U0-G3 | B5-U0-G3 | B5-U0-G3 |
| 5MQ | 4000K/5000K Lumens | 5,290 | 10,337 | 15,424 | 20,380 | 25,250 | 30,217 | 35,734 | 40,489 | 45,165 | 50,006 |
| | 3000K Lumens | 4,683 | 9,150 | 13,653 | 18,040 | 22,351 | 26,748 | 31,632 | 35,841 | 39,980 | 44,265 |
| | BUG Rating | B3-U0-G1 | B3-U0-G2 | B4-U0-G2 | B4-U0-G2 | B5-U0-G3 | B5-U0-G3 | B5-U0-G4 | B5-U0-G4 | B5-U0-G4 | B5-U0-G4 |
| 5WQ | 4000K/5000K Lumens | 5,304 | 10,365 | 15,465 | 20,434 | 25,318 | 30,297 | 35,830 | 40,597 | 45,286 | 50,139 |
| | 3000K Lumens | 4,695 | 9,175 | 13,690 | 18,088 | 22,411 | 26,819 | 31,717 | 35,936 | 40,087 | 44,383 |
| | BUG Rating | B3-U0-G1 | B4-U0-G2 | B4-U0-G2 | B5-U0-G3 | B5-U0-G3 | B5-U0-G4 | B5-U0-G4 | B5-U0-G4 | B5-U0-G5 | B5-U0-G5 |
| SLL/SLR | 4000K/5000K Lumens | 4,426 | 8,648 | 12,903 | 17,049 | 21,124 | 25,278 | 29,894 | 33,872 | 37,784 | 41,832 |
| | 3000K Lumens | 3,918 | 7,655 | 11,422 | 15,092 | 18,699 | 22,376 | 26,462 | 29,983 | 33,446 | 37,030 |
| | BUG Rating | B1-U0-G2 | B1-U0-G2 | B2-U0-G3 | B2-U0-G3 | B2-U0-G4 | B3-U0-G4 | B3-U0-G5 | B3-U0-G5 | B3-U0-G5 | B3-U0-G5 |
| RW | 4000K/5000K Lumens | 5,147 | 10,058 | 15,009 | 19,830 | 24,570 | 29,402 | 34,771 | 39,399 | 43,949 | 48,658 |
| | 3000K Lumens | 4,556 | 8,903 | 13,286 | 17,554 | 21,749 | 26,027 | 30,779 | 34,876 | 38,904 | 43,072 |
| | BUG Rating | B2-U0-G1 | B3-U0-G1 | B3-U0-G2 | B4-U0-G2 | B4-U0-G2 | B4-U0-G2 | B5-U0-G3 | B5-U0-G3 | B5-U0-G3 | B5-U0-G4 |
| AFL | 4000K/5000K Lumens | 5,166 | 10,095 | 15,063 | 19,903 | 24,659 | 29,509 | 34,898 | 39,542 | 44,108 | 48,835 |
| | 3000K Lumens | 4,573 | 8,936 | 13,334 | 17,618 | 21,828 | 26,121 | 30,892 | 35,003 | 39,044 | 43,229 |
| | BUG Rating | B1-U0-G1 | B1-U0-G1 | B2-U0-G2 | B2-U0-G2 | B3-U0-G2 | B3-U0-G3 | B3-U0-G3 | B3-U0-G3 | B3-U0-G3 | B3-U0-G3 |

* Nominal data for 70 CRI.

NOMINAL POWER LUMENS (600MA)

| Number of Light Squares | 1 | 2 | 3 | 4 | 5 | 6 | 7 | 8 | 9 | 10 | |
|---------------------------------|--------------------|----------|----------|----------|----------|----------|----------|----------|----------|----------|----------|
| Nominal Power (Watts) | 34 | 66 | 96 | 129 | 162 | 193 | 226 | 257 | 290 | 323 | |
| Input Current @ 120V (A) | 0.30 | 0.58 | 0.86 | 1.16 | 1.44 | 1.73 | 2.03 | 2.33 | 2.59 | 2.89 | |
| Input Current @ 208V (A) | 0.17 | 0.34 | 0.49 | 0.65 | 0.84 | 0.99 | 1.14 | 1.30 | 1.48 | 1.63 | |
| Input Current @ 240V (A) | 0.15 | 0.30 | 0.43 | 0.56 | 0.74 | 0.87 | 1.00 | 1.13 | 1.30 | 1.43 | |
| Input Current @ 277V (A) | 0.14 | 0.28 | 0.41 | 0.52 | 0.69 | 0.81 | 0.93 | 1.04 | 1.22 | 1.33 | |
| Input Current @ 347V (A) | 0.11 | 0.19 | 0.30 | 0.39 | 0.49 | 0.60 | 0.69 | 0.77 | 0.90 | 0.99 | |
| Input Current @ 480V (A) | 0.08 | 0.15 | 0.24 | 0.30 | 0.38 | 0.48 | 0.53 | 0.59 | 0.71 | 0.77 | |
| Optics | | | | | | | | | | | |
| T2 | 4000K/5000K Lumens | 4,029 | 7,874 | 11,749 | 15,525 | 19,235 | 23,019 | 27,222 | 30,844 | 34,406 | 38,093 |
| | 3000K Lumens | 3,566 | 6,970 | 10,400 | 13,743 | 17,027 | 20,376 | 24,097 | 27,303 | 30,456 | 33,720 |
| | BUG Rating | B1-U0-G1 | B1-U0-G2 | B2-U0-G2 | B2-U0-G2 | B3-U0-G3 | B3-U0-G3 | B3-U0-G4 | B3-U0-G4 | B3-U0-G4 | B3-U0-G4 |
| T2R | 4000K/5000K Lumens | 4,278 | 8,360 | 12,474 | 16,482 | 20,421 | 24,437 | 28,900 | 32,745 | 36,527 | 40,441 |
| | 3000K Lumens | 3,787 | 7,400 | 11,042 | 14,590 | 18,077 | 21,632 | 25,582 | 28,986 | 32,334 | 35,798 |
| | BUG Rating | B1-U0-G1 | B1-U0-G2 | B2-U0-G2 | B2-U0-G2 | B2-U0-G3 | B3-U0-G3 | B3-U0-G3 | B3-U0-G4 | B3-U0-G4 | B3-U0-G4 |
| T3 | 4000K/5000K Lumens | 4,107 | 8,026 | 11,976 | 15,824 | 19,605 | 23,461 | 27,746 | 31,438 | 35,068 | 38,827 |
| | 3000K Lumens | 3,636 | 7,105 | 10,601 | 14,007 | 17,354 | 20,768 | 24,561 | 27,829 | 31,042 | 34,370 |
| | BUG Rating | B1-U0-G1 | B1-U0-G2 | B2-U0-G2 | B2-U0-G3 | B3-U0-G3 | B3-U0-G4 | B3-U0-G4 | B3-U0-G4 | B3-U0-G5 | B3-U0-G5 |
| T3R | 4000K/5000K Lumens | 4,198 | 8,205 | 12,242 | 16,175 | 20,041 | 23,982 | 28,363 | 32,137 | 35,848 | 39,689 |
| | 3000K Lumens | 3,716 | 7,263 | 10,837 | 14,318 | 17,740 | 21,229 | 25,107 | 28,448 | 31,733 | 35,133 |
| | BUG Rating | B1-U0-G1 | B1-U0-G2 | B2-U0-G2 | B2-U0-G3 | B2-U0-G3 | B3-U0-G4 | B3-U0-G4 | B3-U0-G4 | B3-U0-G5 | B3-U0-G5 |
| T4FT | 4000K/5000K Lumens | 4,131 | 8,072 | 12,045 | 15,915 | 19,719 | 23,597 | 27,907 | 31,620 | 35,272 | 39,052 |
| | 3000K Lumens | 3,657 | 7,145 | 10,662 | 14,088 | 17,455 | 20,888 | 24,703 | 27,990 | 31,223 | 34,569 |
| | BUG Rating | B1-U0-G1 | B1-U0-G2 | B2-U0-G2 | B2-U0-G3 | B2-U0-G4 | B3-U0-G4 | B3-U0-G4 | B3-U0-G5 | B3-U0-G5 | B3-U0-G5 |
| T4W | 4000K/5000K Lumens | 4,077 | 7,968 | 11,889 | 15,710 | 19,465 | 23,292 | 27,546 | 31,212 | 34,816 | 38,547 |
| | 3000K Lumens | 3,609 | 7,053 | 10,524 | 13,906 | 17,230 | 20,618 | 24,384 | 27,629 | 30,819 | 34,122 |
| | BUG Rating | B1-U0-G1 | B1-U0-G2 | B2-U0-G2 | B2-U0-G3 | B3-U0-G4 | B3-U0-G4 | B3-U0-G4 | B3-U0-G5 | B3-U0-G5 | B3-U0-G5 |
| SL2 | 4000K/5000K Lumens | 4,022 | 7,861 | 11,729 | 15,498 | 19,202 | 22,979 | 27,175 | 30,791 | 34,347 | 38,028 |
| | 3000K Lumens | 3,560 | 6,959 | 10,383 | 13,719 | 16,998 | 20,341 | 24,055 | 27,256 | 30,404 | 33,662 |
| | BUG Rating | B1-U0-G1 | B1-U0-G2 | B2-U0-G3 | B2-U0-G3 | B3-U0-G3 | B3-U0-G4 | B3-U0-G4 | B3-U0-G4 | B3-U0-G5 | B3-U0-G5 |
| SL3 | 4000K/5000K Lumens | 4,106 | 8,025 | 11,974 | 15,821 | 19,603 | 23,458 | 27,742 | 31,433 | 35,064 | 38,821 |
| | 3000K Lumens | 3,635 | 7,104 | 10,599 | 14,005 | 17,353 | 20,765 | 24,557 | 27,824 | 31,039 | 34,364 |
| | BUG Rating | B1-U0-G1 | B1-U0-G2 | B2-U0-G3 | B2-U0-G3 | B2-U0-G3 | B3-U0-G4 | B3-U0-G4 | B3-U0-G4 | B3-U0-G5 | B3-U0-G5 |
| SL4 | 4000K/5000K Lumens | 3,902 | 7,624 | 11,377 | 15,033 | 18,626 | 22,289 | 26,359 | 29,867 | 33,316 | 36,886 |
| | 3000K Lumens | 3,454 | 6,749 | 10,071 | 13,307 | 16,488 | 19,730 | 23,333 | 26,438 | 29,491 | 32,651 |
| | BUG Rating | B1-U0-G2 | B1-U0-G2 | B1-U0-G3 | B1-U0-G3 | B2-U0-G4 | B2-U0-G4 | B2-U0-G4 | B2-U0-G5 | B3-U0-G5 | B3-U0-G5 |
| 5NQ | 4000K/5000K Lumens | 4,236 | 8,277 | 12,351 | 16,319 | 20,219 | 24,196 | 28,614 | 32,422 | 36,166 | 40,042 |
| | 3000K Lumens | 3,750 | 7,327 | 10,933 | 14,446 | 17,898 | 21,418 | 25,329 | 28,700 | 32,014 | 35,445 |
| | BUG Rating | B2-U0-G1 | B3-U0-G1 | B3-U0-G2 | B3-U0-G2 | B4-U0-G2 | B4-U0-G2 | B4-U0-G2 | B5-U0-G2 | B5-U0-G3 | B5-U0-G3 |
| 5MQ | 4000K/5000K Lumens | 4,314 | 8,429 | 12,578 | 16,619 | 20,591 | 24,641 | 29,141 | 33,019 | 36,832 | 40,779 |
| | 3000K Lumens | 3,819 | 7,461 | 11,134 | 14,711 | 18,227 | 21,812 | 25,796 | 29,228 | 32,604 | 36,098 |
| | BUG Rating | B3-U0-G1 | B3-U0-G2 | B4-U0-G2 | B4-U0-G2 | B4-U0-G2 | B5-U0-G3 | B5-U0-G3 | B5-U0-G4 | B5-U0-G4 | B5-U0-G4 |
| 5WQ | 4000K/5000K Lumens | 4,325 | 8,452 | 12,611 | 16,664 | 20,646 | 24,707 | 29,219 | 33,106 | 36,930 | 40,888 |
| | 3000K Lumens | 3,828 | 7,482 | 11,163 | 14,751 | 18,276 | 21,871 | 25,865 | 29,305 | 32,690 | 36,194 |
| | BUG Rating | B3-U0-G1 | B3-U0-G2 | B4-U0-G2 | B4-U0-G2 | B5-U0-G3 | B5-U0-G3 | B5-U0-G4 | B5-U0-G4 | B5-U0-G4 | B5-U0-G4 |
| SLL/SLR | 4000K/5000K Lumens | 3,609 | 7,052 | 10,522 | 13,903 | 17,226 | 20,613 | 24,378 | 27,622 | 30,812 | 34,114 |
| | 3000K Lumens | 3,195 | 6,242 | 9,314 | 12,307 | 15,248 | 18,247 | 21,579 | 24,451 | 27,275 | 30,198 |
| | BUG Rating | B1-U0-G1 | B1-U0-G2 | B1-U0-G3 | B2-U0-G3 | B2-U0-G3 | B2-U0-G4 | B3-U0-G4 | B3-U0-G4 | B3-U0-G5 | B3-U0-G5 |
| RW | 4000K/5000K Lumens | 4,197 | 8,202 | 12,239 | 16,171 | 20,036 | 23,977 | 28,356 | 32,129 | 35,839 | 39,680 |
| | 3000K Lumens | 3,715 | 7,260 | 10,834 | 14,315 | 17,736 | 21,224 | 25,101 | 28,441 | 31,725 | 35,125 |
| | BUG Rating | B2-U0-G1 | B3-U0-G1 | B3-U0-G2 | B4-U0-G2 | B4-U0-G2 | B4-U0-G2 | B4-U0-G2 | B5-U0-G3 | B5-U0-G3 | B5-U0-G3 |
| AFL | 4000K/5000K Lumens | 4,213 | 8,232 | 12,284 | 16,230 | 20,109 | 24,064 | 28,459 | 32,246 | 35,969 | 39,824 |
| | 3000K Lumens | 3,729 | 7,287 | 10,874 | 14,367 | 17,800 | 21,301 | 25,192 | 28,544 | 31,840 | 35,252 |
| | BUG Rating | B1-U0-G1 | B1-U0-G1 | B2-U0-G2 | B2-U0-G2 | B2-U0-G2 | B3-U0-G2 | B3-U0-G3 | B3-U0-G3 | B3-U0-G3 | B3-U0-G3 |

* Nominal data for 70 CRI.

CONTROL OPTIONS

0-10V (DIM)

This fixture is offered standard with 0-10V dimming driver(s). The DIM option provides 0-10V dimming wire leads for use with a lighting control panel or other control method.

Photocontrol (P, R and PER7)

Optional button-type photocontrol (P) and photocontrol receptacles (R and PER7) provide a flexible solution to enable "dusk-to-dawn" lighting by sensing light levels. Advanced control systems compatible with NEMA 7-pin standards can be utilized with the PER7 receptacle.

After Hours Dim (AHD)

This feature allows photocontrol-enabled luminaires to achieve additional energy savings by dimming during scheduled portions of the night. The dimming profile will automatically take effect after a "dusk-to-dawn" period has been calculated from the photocontrol input. Specify the desired dimming profile for a simple, factory-shipped dimming solution requiring no external control wiring. Reference the After Hours Dim supplemental guide for additional information.

Dimming Occupancy Sensor (MS/DIM-LXX, MS/X-LXX and MS-LXX)

These sensors are factory installed in the luminaire housing. When the MS/DIM-LXX sensor option is selected, the occupancy sensor is connected to a dimming driver and the entire luminaire dims when there is no activity detected. When activity is detected, the luminaire returns to full light output. The MS/DIM sensor is factory preset to dim down to approximately 50 percent power with a time delay of five minutes. The MS-LXX sensor is factory preset to turn the luminaire off after five minutes of no activity. The MS/X-LXX is also preset for five minutes and only controls the specified number of light engines to maintain steady output from the remaining light engines.

These occupancy sensors includes an integral photocell that can be activated with the FSIR-100 accessory for "dusk-to-dawn" control or daylight harvesting - the factory preset is OFF. The FSIR-100 is a wireless tool utilized for changing the dimming level, time delay, sensitivity and other parameters.

A variety of sensor lens are available to optimize the coverage pattern for mounting heights from 8'-40'.

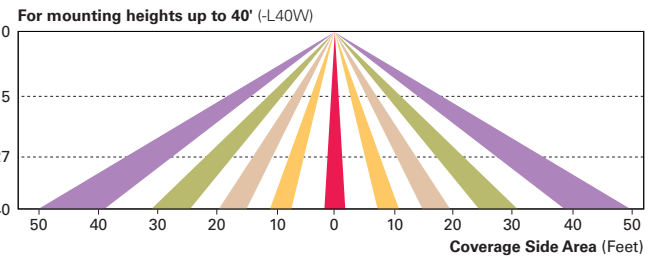
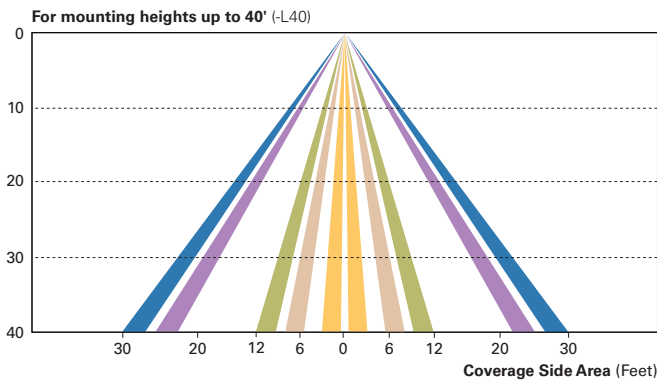
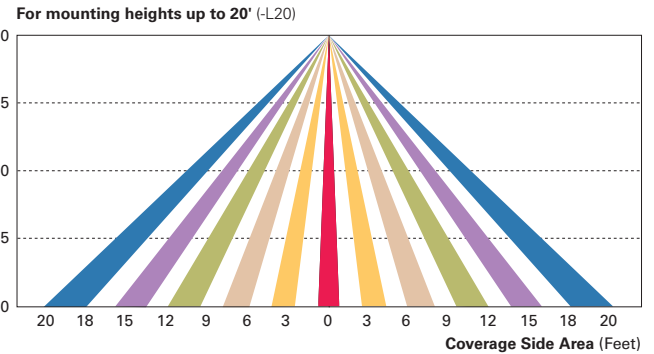
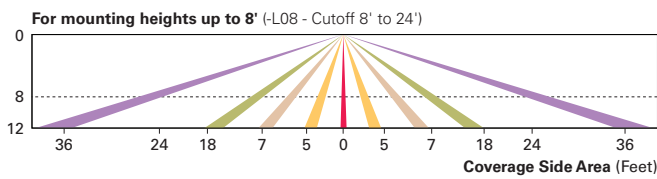

LumaWatt Pro Wireless Control and Monitoring System (LWR-LW and LWR-LN)

The LumaWatt Pro system is a peer-to-peer wireless network of luminaire-integral sensors for any sized project. Each sensor is capable of motion and photo sensing, metering power consumption and wireless communication. The end-user can securely create and manage sensor profiles with browser-based management software. The software will automatically broadcast to the sensors via wireless gateways for zone-based and individual luminaire control. The LumaWatt Pro software provides smart building solutions by utilizing the sensor to provide easy-to-use dashboard and analytic capabilities such as improved energy savings, traffic flow analysis, building management software integration and more.

For additional details, refer to the LumaWatt Pro product guides.

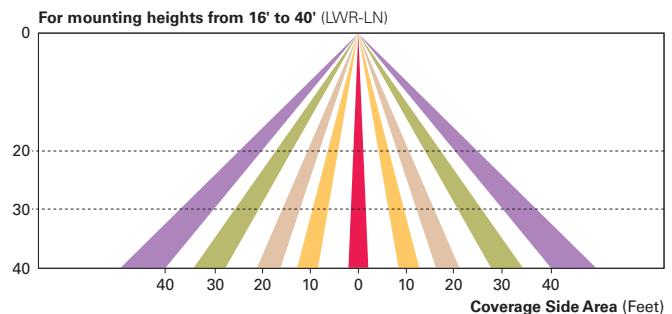
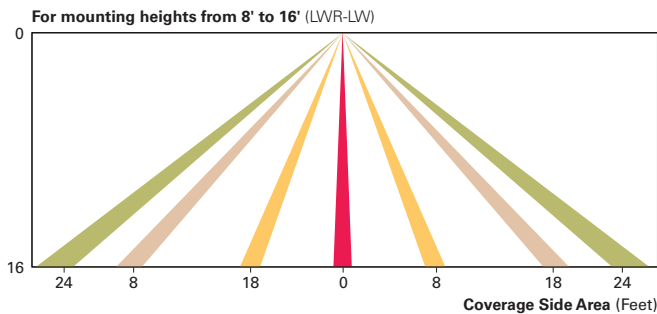

ORDERING INFORMATION

Sample Number: GLEON-AF-04-LED-E1-T3-GM-QM

| Product Family ^{1,2} | Light Engine | Number of Light Squares ³ | Lamp Type | Voltage | Distribution | Color | Mounting |
|-------------------------------|---------------------|--|---------------------------------------|---|--|---|--|
| GLEON=Galleon | AF=1A Drive Current | 01=1 02=2 03=3 04=4 05=5 ⁴ 06=6 07=7 ⁵ 08=8 ⁵ 09=9 ⁶ 10=10 ⁶ | LED=Solid State Light Emitting Diodes | E1=120-277V 347=347V ⁷ 480=480V ^{7,8} | T2=Type II T2R=Type II Roadway T3=Type III T3R=Type III Roadway T4FT=Type IV Forward Throw T4W=Type IV Wide 5NQ=Type V Narrow 5MQ=Type V Square Medium 5WO=Type V Square Wide SL2=Type II w/Spill Control SL3=Type III w/Spill Control SL4=Type IV w/Spill Control SLL=90° Spill Light Eliminator Left SLR=90° Spill Light Eliminator Right RW=Rectangular Wide Type I AFL=Automotive Frontline | AP=Grey BZ=Bronze BK=Black DP=Dark Platinum GM=Graphite Metallic WH=White | [Blank]=Arm for Round or Square Pole EA=Extended Arm ⁹ MA=Mast Arm Adapter ¹⁰ WM=Wall Mount QM=Quick Mount Arm (Standard Length) ¹¹ QMEA=Quick Mount Arm (Extended Length) ¹² |

| Options (Add as Suffix) | Accessories (Order Separately) |
|---|---|
| <p>7030=70 CRI 3000K¹³ 8030=80 CRI 3000K¹⁴ 7050=70 CRI 5000K¹³ 7060=70 CRI 6000K¹³ 600=Drive Current Factory Set to Nominal 600mA¹⁵ 800=Drive Current Factory Set to Nominal 800mA¹⁵ 1200=Drive Current Factory Set to Nominal 1200mA^{15,16} F=Single Fuse (120, 277 or 347V. Must Specify Voltage) FF=Double Fuse (208, 240 or 480V. Must Specify Voltage) 2L=Two Circuits^{17,18} DIM=External 0-10V Dimming Leads^{19,20} P=Button Type Photocontrol (120, 208, 240 or 277V. Must Specify Voltage)²¹ PER7=NEMA 7-PIN Twistlock Photocontrol Receptacle²¹ R=NEMA Twistlock Photocontrol Receptacle²¹ AHD145=After Hours Dim, 5 Hours²² AHD245=After Hours Dim, 6 Hours²² AHD255=After Hours Dim, 7 Hours²² AHD355=After Hours Dim, 8 Hours²² HA=50°C High Ambient²³ MS/DIM-L08=Motion Sensor for Dimming Operation, Maximum 8' Mounting Height^{24,25} MS/DIM-L20=Motion Sensor for Dimming Operation, 9' - 20' Mounting Height^{24,25} MS/DIM-L40=Motion Sensor for Dimming Operation, 21' - 40' Mounting Height^{24,25} MS/DIM-L40W=Motion Sensor for Dimming Operation, 21' - 40' Mounting Height (Wide Range)^{24,28} MS/X-L08=Bi-Level Motion Sensor, Maximum 8' Mounting Height^{24,25,29} MS/X-L20=Bi-Level Motion Sensor, 9' - 20' Mounting Height^{24,25,29} MS/X-L40=Bi-Level Motion Sensor, 21' - 40' Mounting Height^{22,27,29} MS/X-L40W=Bi-Level Motion Sensor, 21' - 40' Mounting Height (Wide Range)^{24,28,29} MS-L08=Motion Sensor for ON/OFF Operation, Maximum 8' Mounting Height^{24,25} MS-L20=Motion Sensor for ON/OFF Operation, 9' - 20' Mounting Height^{24,26} MS-L40=Motion Sensor for ON/OFF Operation, 21' - 40' Mounting Height^{24,27} MS-L40W=Motion Sensor for ON/OFF Operation, 21' - 40' Mounting Height (Wide Range)^{24,28} LWR-LW=LumaWatt Pro Wireless Sensor, Wide Lens for 8' - 16' Mounting Height³⁰ LWR-LN=LumaWatt Pro Wireless Sensor, Narrow Lens for 16' - 40' Mounting Height³⁰ L90=Optics Rotated 90° Left R90=Optics Rotated 90° Right MT=Factory Installed Mesh Top TH=Tool-less Door Hardware LCF=Light Square Trim Plate Painted to Match Housing³¹ HSS=Factory Installed House Side Shield³² CE=CE Marking³³</p> | <p>OA/RA1016=NEMA Photocontrol Multi-Tap - 105-285V OA/RA1027=NEMA Photocontrol - 480V OA/RA1201=NEMA Photocontrol - 347V OA/RA1013=Photocontrol Shorting Cap OA/RA1014=120V Photocontrol MA1252=10kV Surge Module Replacement MA1036-XX=Single Tenon Adapter for 2-3/8" O.D. Tenon MA1037-XX=2 @ 180° Tenon Adapter for 2-3/8" O.D. Tenon MA1197-XX=3 @ 120° Tenon Adapter for 2-3/8" O.D. Tenon MA1188-XX=4 @ 90° Tenon Adapter for 2-3/8" O.D. Tenon MA1189-XX=2 @ 90° Tenon Adapter for 2-3/8" O.D. Tenon MA1190-XX=3 @ 90° Tenon Adapter for 2-3/8" O.D. Tenon MA1191-XX=2 @ 120° Tenon Adapter for 2-3/8" O.D. Tenon MA1038-XX=Single Tenon Adapter for 3-1/2" O.D. Tenon MA1039-XX=2 @ 180° Tenon Adapter for 3-1/2" O.D. Tenon MA1192-XX=3 @ 120° Tenon Adapter for 3-1/2" O.D. Tenon MA1193-XX=4 @ 90° Tenon Adapter for 3-1/2" O.D. Tenon MA1194-XX=2 @ 90° Tenon Adapter for 3-1/2" O.D. Tenon MA1195-XX=3 @ 90° Tenon Adapter for 3-1/2" O.D. Tenon FSIR-100=Wireless Configuration Tool for Occupancy Sensor²⁴ GLEON-MT1=Field Installed Mesh Top for 1-4 Light Squares GLEON-MT2=Field Installed Mesh Top for 5-6 Light Squares GLEON-MT3=Field Installed Mesh Top for 7-8 Light Squares GLEON-MT4=Field Installed Mesh Top for 9-10 Light Squares GLEON-QM=Quick Mount Arm Kit¹⁰ GLEON-QMEA=Quick Mount Extended Arm Kit¹¹ LS/HSS=Field Installed House Side Shield^{32,34}</p> |

- NOTES:**
- Customer is responsible for engineering analysis to confirm pole and fixture compatibility for all applications. Refer to our white paper WP513001EN for additional support information.
 - DesignLights Consortium® Qualified. Refer to www.designlights.org Qualified Products List under Family Models for details.
 - Standard 4000K CCT and minimum 70 CRI.
 - Not compatible with MS/4-LXX or MS/1-LXX sensors.
 - Not compatible with extended quick mount arm (QMEA).
 - Not compatible with standard quick mount arm (QM) or extended quick mount arm (QMEA).
 - Requires the use of an internal step down transformer when combined with sensor options. Not available with sensor at 1200mA. Not available in combination with the HA high ambient and sensor options at 1A.
 - Only for use with 480V Wye systems. Per NEC, not for use with ungrounded systems, impedance grounded systems or corner grounded systems (commonly known as Three Phase Three Wire Delta, Three Phase High Leg Delta and Three Phase Corner Grounded Delta systems).
 - May be required when two or more luminaires are oriented on a 90° or 120° drilling pattern. Refer to arm mounting requirement table.
 - Factory installed.
 - Maximum 8 light squares.
 - Maximum 6 light squares.
 - Extended lead times apply. Use dedicated IES files for 3000K, 5000K and 6000K when performing layouts. These files are published on the Galleon luminaire product page on the website.
 - Extended lead times apply. Use dedicated IES files for 3000K, 5000K and 6000K when performing layouts. These files are published on the Galleon luminaire product page on the website.
 - 1 Amp standard. Use dedicated IES files for 600mA, 800mA and 1200mA when performing layouts. These files are published on the Galleon luminaire product page on the website.
 - Not available with HA option.
 - 2L is not available with MS, MS/X or MS/DIM at 347V or 480V. 2L in AF-02 through AF-04 requires a larger housing, normally used for AF-05 or AF-06. Extended arm option may be required when mounting two or more fixtures per pole at 90° or 120°. Refer to arm mounting requirement table.
 - Not available with LumaWatt Pro wireless sensors.
 - Cannot be used with other control options.
 - Low voltage control lead brought out 18" outside fixture.
 - Not available if any "MS" sensor is selected. Motion sensor has an integral photocell.
 - Requires the use of P photocontrol or the PER7 or R photocontrol receptacle with photocontrol accessory. See After Hours Dim supplemental guide for additional information.
 - 50°C lumen maintenance data applies to 600mA, 800mA and 1A drive currents.
 - The FSIR-100 configuration tool is required to adjust parameters including high and low modes, sensitivity, time delay, cutoff and more. Consult your lighting representative at Eaton for more information.
 - Approximately 22' detection diameter at 8' mounting height.
 - Approximately 40' detection diameter at 20' mounting height.
 - Approximately 60' detection diameter at 40' mounting height.
 - Approximately 100' detection diameter at 40' mounting height.
 - Replace X with number of Light Squares operating in low output mode.
 - LumaWatt Pro wireless sensors are factory installed only requiring network components LWP-EM-1, LWP-GW-1 and LWP-PoE8 in appropriate quantities. See www.eaton.com/lighting for LumaWatt Pro application information.
 - Not available with house side shield (HSS).
 - Only for use with SL2, SL3, SL4 and AFL distributions. The Light Square trim plate is painted black when the HSS option is selected.
 - CE is not available with the LWR, MS, MS/X, MS/DIM, P, R or PER7 options. Available in 120-277V only.
 - One required for each Light Square.



Eaton
1121 Highway 74 South
Peachtree City, GA 30269
P: 770-486-4800
www.eaton.com/lighting

Specifications and dimensions subject to change without notice.



SSS SQUARE STRAIGHT STEEL

| | | |
|-------------|--|------|
| Catalog # | | Type |
| Project | | |
| Comments | | Date |
| Prepared by | | |

FEATURES

- ASTM Grade steel base plate with ASTM A366 base cover
- Hand hole assembly 3" x 5" on 5" and 6" pole; and 2" x 4" on 4" pole
- 10'-39' mounting heights
- Drilled or tenon (specify)

ORDERING INFORMATION

SAMPLE NUMBER: SSS5A20SFM1XG

| Product Family | Shaft Size (Inches) ¹ | Wall Thickness (Inches) | Mounting Height (Feet) | Base Type | Finish | Mounting Type | Number and Location of Arms | Arm Lengths (Feet) | Options (Add as Suffix) |
|---------------------------|----------------------------------|----------------------------------|--|---------------------|--|---|--|--------------------|--|
| SSS=Square Straight Steel | 4=4" 5=5" 6=6" | A=0.120" M=0.188" X=0.250" | 10=10' 15=15' 20=20' 25=25' 30=30' 35=35' 39=39' | S=Square Steel Base | F=Dark Bronze G=Galvanized Steel J=Summit White K=Carbon Bronze L=Dark Platinum P=Primer Powder Coat R=Hartford Green S=Silver T=Graphite Metallic V=Grey W=White X=Custom Color Y=Black | 2=2-3/8" O.D. Tenon (4" Long) 3=3-1/2" O.D. Tenon (5" Long) 4=4" O.D. Tenon (6" Long) 5=3" O.D. Tenon (4" Long) 6=2-3/8" O.D. Tenon (6" Long) 7=4" O.D. Tenon (10" Long) A=Type A Drilling C=Type C Drilling E=Type E Drilling F=Type F Drilling G=Type G Drilling J=Type J Drilling K=Type K Drilling M=Type M Drilling R=Type R Drilling Z=Type Z Drilling | 1=Single 2=2 at 180° 3=Triple ² 4=4 at 90° 5=2 at 90° X=None | X=None | A=1/2" Tapped Hub (Specify location desired) B=3/4" Tapped Hub (Specify location desired) C=Convenience Outlet ³ E=GFCI Convenience Outlet ³ G=Ground Lug H=Additional Hand Hole ⁴ L=Drilled for Bumper Glitter V=Vibration Damper |

NOTES: 1. All shaft sizes nominal. 2. Square poles are 3 at 90°, round poles are 3 at 120°. 3. Outlet is located 4' above base and on same side of pole as hand hole, unless specified otherwise. Receptacle not included, provision only. 4. Additional hand hole is located 12" below pole top and 90° from standard hand hole location, unless otherwise specified.

DIMENSIONS

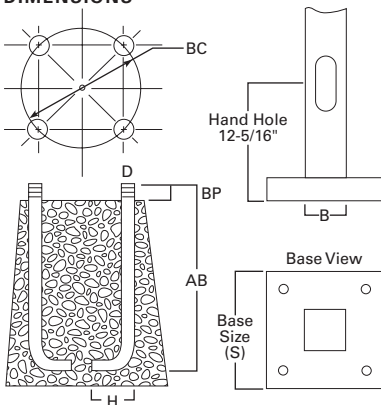

WARNING: The use of unauthorized accessories such as banners, signs, cameras or pennants for which the pole was not designed voids the pole warranty from Eaton's Cooper Lighting business and may result in pole failure causing serious injury or property damage. Upon request, Eaton's Cooper Lighting business will supply information regarding total loading capacity. The pole warranty from Eaton's Cooper Lighting business is void unless poles are used and installed as a complete pole/luminaire combination. This warranty specifically excludes failure as the result of a third party act or omission, misuse, unanticipated uses, fatigue failure or similar phenomena resulting from induced vibration, harmonic oscillation or resonance associated with movement of air currents around the product.

Specifications and dimensions subject to change without notice. Consult your Eaton's Cooper Lighting business representative or visit www.cooperlighting.com for available options, accessories and ordering information.

Effective Projected Area (At Pole Top)

| Mounting Height (Feet) | Catalog Number ^{1,2} | Wall Thickness (Inches) | Base Square ³ (Inches) | Bolt Circle Diameter (Inches) | Anchor Bolt Projection ³ (Inches) | Shaft Size ³ (Inches) | Anchor Bolt Diameter x Length x Hook (Inches) | Net Weight (Pounds) | Maximum Effective Projected Area (Square Feet) ⁴ | | | | Max. Fixture Load - Includes Bracket (Pounds) |
|------------------------|-------------------------------|-------------------------|-----------------------------------|-------------------------------|--|----------------------------------|---|---------------------|---|--------|---------|---------|---|
| | | | | | | | | | 80 mph | 90 mph | 100 mph | 110 mph | |
| MH | | | S | BC | BP | B | D x AB x H | | | | | | |
| 10 | SSS4A10S | 0.120 | 10-1/2 | 11 | 4-1/2 | 4 | 3/4 x 25 x 3 | 85 | 30.0 | 22.0 | 17.0 | 13.0 | 100 |
| 15 | SSS4A15S | 0.120 | 10-1/2 | 11 | 4-1/2 | 4 | 3/4 x 25 x 3 | 118 | 15.0 | 11.5 | 8.7 | 6.5 | 100 |
| 20 | SSS4A20S | 0.120 | 10-1/2 | 11 | 4-1/2 | 4 | 3/4 x 25 x 3 | 150 | 8.7 | 5.9 | 3.9 | 2.5 | 150 |
| 20 | SSS5A20S | 0.120 | 10-1/2 | 11 | 4-1/2 | 5 | 3/4 x 25 x 3 | 183 | 15.4 | 11.1 | 7.9 | 5.5 | 150 |
| 25 | SSS4A25S | 0.120 | 10-1/2 | 11 | 4-1/2 | 4 | 3/4 x 25 x 3 | 181 | 3.7 | 1.7 | 0.3 | -- | 200 |
| 25 | SSS5A25S | 0.120 | 10-1/2 | 11 | 5 | 5 | 3/4 x 25 x 3 | 222 | 9.3 | 6.0 | 3.5 | 1.6 | 200 |
| 25 | SSS6A25S | 0.120 | 12-1/2 | 12-1/2 | 5 | 6 | 1 x 36 x 4 | 284 | 9.9 | 6.1 | 3.5 | 1.2 | 200 |
| 30 | SSS5A30S | 0.120 | 10-1/2 | 11 | 4-1/2 | 5 | 3/4 x 25 x 3 | 260 | 4.7 | 2.1 | -- | -- | 200 |
| 30 | SSS5M30S | 0.188 | 10-1/2 | 11 | 4-1/2 | 5 | 3/4 x 25 x 3 | 392 | 10.4 | 6.4 | 3.5 | 1.5 | 200 |
| 30 | SSS6A30S | 0.120 | 12-1/2 | 12-1/2 | 5 | 6 | 1 x 36 x 4 | 330 | 4.3 | 1.4 | -- | -- | 200 |
| 30 | SSS6M30S | 0.188 | 12-1/2 | 12-1/2 | 5 | 6 | 1 x 36 x 4 | 489 | 19.0 | 13.0 | 8.7 | 5.6 | 200 |
| 35 | SSS5M35S | 0.188 | 10-1/2 | 11 | 4-1/2 | 5 | 3/4 x 25 x 3 | 453 | 5.8 | 2.8 | -- | -- | 200 |
| 35 | SSS6M35S | 0.188 | 12-1/2 | 12-1/2 | 5 | 6 | 1 x 36 x 4 | 564 | 12.8 | 7.2 | 3.7 | 1.0 | 200 |
| 35 | SSS6X35S | 0.250 | 12-1/2 | 12-1/2 | 5 | 6 | 1 x 36 x 4 | 738 | 16.5 | 11.0 | 6.8 | 3.5 | 200 |
| 39 | SSS6M39S | 0.188 | 12-1/2 | 12-1/2 | 5 | 6 | 1 x 36 x 4 | 618 | 7.3 | 3.0 | -- | -- | 300 |
| 39 | SSS6X39S | 0.250 | 12-1/2 | 12-1/2 | 5 | 6 | 1 x 36 x 4 | 816 | 13.0 | 7.0 | 3.7 | 0.8 | 300 |

Effective Projected Area (Two Feet Above Pole Top)

| Mounting Height (Feet) | Catalog Number ^{1,2} | Wall Thickness (Inches) | Base Square ³ (Inches) | Bolt Circle Diameter (Inches) | Anchor Bolt Projection ³ (Inches) | Shaft Size ³ (Inches) | Anchor Bolt Diameter x Length x Hook (Inches) | Net Weight (Pounds) | Maximum Effective Projected Area (Square Feet) ⁴ | | | | Max. Fixture Load - Includes Bracket (Pounds) |
|------------------------|-------------------------------|-------------------------|-----------------------------------|-------------------------------|--|----------------------------------|---|---------------------|---|--------|---------|---------|---|
| | | | | | | | | | 80 mph | 90 mph | 100 mph | 110 mph | |
| MH | | | S | BC | BP | B | D x AB x H | | | | | | |
| 10 | SSS4A10S | 0.120 | 10-1/2 | 11 | 4-1/2 | 4 | 3/4 x 25 x 3 | 85 | 23.0 | 17.5 | 14.0 | 11.0 | 100 |
| 15 | SSS4A15S | 0.120 | 10-1/2 | 11 | 4-1/2 | 4 | 3/4 x 25 x 3 | 118 | 13.4 | 10.0 | 7.5 | 5.7 | 100 |
| 20 | SSS4A20S | 0.120 | 10-1/2 | 11 | 4-1/2 | 4 | 3/4 x 25 x 3 | 150 | 7.6 | 5.2 | 3.4 | 2.1 | 150 |
| 20 | SSS5A20S | 0.120 | 10-1/2 | 11 | 4-1/2 | 5 | 3/4 x 25 x 3 | 183 | 13.8 | 9.9 | 7.1 | 4.9 | 150 |
| 25 | SSS4A25S | 0.120 | 10-1/2 | 11 | 4-1/2 | 4 | 3/4 x 25 x 3 | 181 | 3.4 | 1.6 | 0.3 | -- | 200 |
| 25 | SSS5A25S | 0.120 | 10-1/2 | 11 | 5 | 5 | 3/4 x 25 x 3 | 222 | 8.5 | 5.5 | 3.2 | 1.5 | 200 |
| 25 | SSS6A25S | 0.120 | 12-1/2 | 12-1/2 | 5 | 6 | 1 x 36 x 4 | 284 | 9.1 | 5.6 | 3.0 | 1.2 | 200 |
| 30 | SSS5A30S | 0.120 | 10-1/2 | 11 | 4-1/2 | 5 | 3/4 x 25 x 3 | 260 | 1.8 | -- | -- | -- | 200 |
| 30 | SSS5M30S | 0.188 | 10-1/2 | 11 | 4-1/2 | 5 | 3/4 x 25 x 3 | 392 | 9.6 | 5.9 | 1.9 | 0.2 | 200 |
| 30 | SSS6A30S | 0.120 | 12-1/2 | 12-1/2 | 5 | 6 | 1 x 36 x 4 | 330 | 4.1 | 1.3 | -- | -- | 200 |
| 30 | SSS6M30S | 0.188 | 12-1/2 | 12-1/2 | 5 | 6 | 1 x 36 x 4 | 489 | 18.5 | 12.5 | 8.4 | 5.3 | 200 |
| 35 | SSS5M35S | 0.188 | 10-1/2 | 11 | 4-1/2 | 5 | 3/4 x 25 x 3 | 453 | 5.5 | 2.4 | -- | -- | 200 |
| 35 | SSS6M35S | 0.188 | 12-1/2 | 12-1/2 | 5 | 6 | 1 x 36 x 4 | 564 | 11.8 | 7.0 | 3.5 | 1.0 | 200 |
| 35 | SSS6X35S | 0.250 | 12-1/2 | 12-1/2 | 5 | 6 | 1 x 36 x 4 | 738 | 16.0 | 10.5 | 6.4 | 3.4 | 200 |
| 39 | SSS6M39S | 0.188 | 12-1/2 | 12-1/2 | 5 | 6 | 1 x 36 x 4 | 618 | 7.0 | 2.4 | -- | -- | 300 |
| 39 | SSS6X39S | 0.250 | 12-1/2 | 12-1/2 | 5 | 6 | 1 x 36 x 4 | 816 | 12.0 | 6.7 | 3.0 | 0.5 | 300 |

NOTES:

1. Catalog number includes pole with hardware kit. Anchor bolts not included. Before installing, make sure proper anchor bolts and templates are obtained from Eaton's Cooper Lighting business.
2. Tenon size or machining for rectangular arms must be specified. Hand hole position relative to drill location.
3. Shaft size, base square, anchor bolts and projections may vary slightly. All dimensions nominal.
4. EPAs based on shaft properties with wind normal to flat. EPAs calculated using base wind velocity as indicated plus 30% gust factor.