



AGENDA
CITY OF CEDAR FALLS, IOWA
PLANNING AND ZONING COMMISSION MEETING
WEDNESDAY, APRIL 28, 2021
5:30 PM AT CITY HALL AND VIA VIDEO CONFERENCE

The meeting will also be accessible via video conference and the public may access/participate in the meeting in the following ways:

- a) By dialing the phone number +1 312 626 6799 or +1 929 205 6099 or +1 301 715 8592 or +1 346 248 7799 or +1 669 900 6833 or +1 253 215 8782 and when prompted, enter the meeting ID (access code) 886 2008 9534.
- b) iPhone one-tap: +13126266799,,88620089534# or +19292056099,,88620089534#
- c) Join via smartphone or computer using this link: <https://us02web.zoom.us/j/88620089534>.
- d) View the live stream on Channel 15 YouTube using this link: <https://www.youtube.com/channel/UCCzeig5nIS-dlEYisqah1uQ> (view only).
- e) Watch on Cedar Falls Cable Channel 15 (view only).

Call to Order and Roll Call

Approval of Minutes

1. Planning and Zoning Commission Regular Meeting Minutes of April 14, 2021 and Special Meeting minutes from March 17, 2021

Public Comments

Old Business

2. **Central Business District Overlay Site Plan Review (Case #SP20-012)**
Proposal: New Mixed Use Building
Location: 7th & Main
Applicant: Hi Yield, LLC (Brent Dahlstrom), Rose Schroder, AICP Bolton & Meck, Inc, and Slingshot Architecture
Previous Discussion: February 24, 2021
Recommendation: *Per applicant request, defer to a future meeting to allow time for applicant to address the parking*
P&Z Action: *Consider deferral to a future meeting*
3. **Minor Subdivision Plat – Lot 2 of Blain’s Corner 2nd Addition (Case #MP21-001)**
Proposal: Minor plat of Lot 2 of Blain’s Corner 2nd Addition
Location: 219 Brandilynn Boulevard
Owner/Applicant: Davenport Farm and Fleet Inc./Andrea Rand, ISG Inc.
Previous Discussion: April 14, 2021
Recommendation: *Recommend approval*
P&Z Action: *Make a recommendation to City Council*
4. **Hwy-1 Site Plan – Aldi’s (Case #SP21-005)**
Proposal: Hwy-1 Site Plan for Aldi’s grocery store
Location: 219 Brandilynn Boulevard (next to Blain’s Farm and Fleet)
Owner/Applicant: Davenport Farm and Fleet Inc./Andrea Rand, ISG Inc.
Previous Discussion: April 14, 2021
Recommendation: *Recommend approval*
P&Z Action: *Make a recommendation to City Council*

5. Zoning Code Text Amendments – Downtown Character District Regulations

Proposal: New zoning regulations for the Downtown Character District

Recommendation: *public hearing and discuss any additional proposed amendments to the public review draft of the Downtown Character District regulations*

P&Z Action: *Discuss, provide direction, and either continue to the next meeting if more time is needed for public discussion or close the public hearing with the anticipation that a recommendation to Council will be made at the May 12th meeting.*

6. Rezoning of property in the proposed Downtown Character District (Case #RZ21-004)

Proposal: Rezone all property within the proposed Downtown Character District to CD-DT (Downtown Character District).

Recommendation: *Hold public hearing and continue to the May 12th meeting.*

P&Z Action: *Discuss, provide direction, and continue the public hearing to the next meeting.*

New Business

7. HWY-1 Site Plan – Scooter’s Coffee (Case #SP20-012)

Proposal: New Drive-thru and Sit-down Coffee Establishment

Location: 315 Viking Plaza Drive

Applicant: B3 Brew, LLC (developer); Robinson Engineering (engineer)

Previous Discussion: None

Recommendation: *Recommend approval*

P&Z Action: *Make a recommendation to City Council*

8. Central Business District Overlay Design Review – Taylor Vet Clinic (Case #DR20-004)

Proposal: Interior remodel and updating exterior façade, roof and signage.

Location: 315 State Street

Applicant: CJS Ventures LLC (owner); Emergent Architecture (architect)

Previous Discussion: None

Recommendation: *Recommend approval*

P&Z Action: *Make a recommendation to City Council*

Commission Updates

Adjournment

Reminders:

* May 12 and May 26 - Planning & Zoning Commission Meetings

* May 3 and May 17 - City Council Meetings

**Cedar Falls Planning and Zoning Commission
Regular Meeting
April 14, 2021
Via Videoconference
Cedar Falls, Iowa**

MINUTES

The Cedar Falls Planning and Zoning Commission met in regular session on April 14, 2021 at 5:30 p.m. at City Hall and via videoconference due to precautions necessary to prevent the spread of the COVID-19 virus. The following Commission members were present: Hartley, Holst, Larson, Leeper, Lynch, Prideaux, Saul, Schrad and Sears. Karen Howard, Community Services Manager, Jaydevsinh Atodaria, Planner I and Chris Sevy, Planner I, were also present.

- 1.) Chair Leeper noted the Minutes from the March 24, 2021 regular meeting and February 17, 2021 special meeting are presented. Ms. Saul made a motion to approve the Minutes as presented. Ms. Prideaux seconded the motion. The motion was approved unanimously with 9 ayes (Hartley, Holst, Larson, Leeper, Lynch, Prideaux, Saul, Schrad and Sears), and 0 nays.
- 2.) The first item of business was a Central Business District Overlay Site Plan Review for a new mixed-use building at 7th and Main Streets. Chair Leeper introduced the item and explained that it is to be deferred to a future meeting.

Ms. Saul made a motion to approve the deferral. Mr. Hartley seconded the motion. The motion was approved unanimously with 9 ayes (Hartley, Holst, Larson, Leeper, Lynch, Prideaux, Saul, Schrad and Sears), and 0 nays.

- 3.) The next item for consideration by the Commission was a land use map amendment and rezoning from M-1 to HWY-1 at 7009 Nordic Drive. Chair Leeper introduced the item and explained that the application has been withdrawn by the applicant, so no action is needed.
- 4.) The Commission then considered a rezoning request near Huntington Road and Cedar Heights Drive from A-1 Agricultural District and R-1 Residential District to MU Mixed Use Residential District, and to update the Pinnacle Prairie Master Plan to include this new area. Chair Leeper introduced the item and Ms. Howard provided background information. She explained that approximately 12 acres of the property would be rezoned from A-1 to MU and approximately three acres from R-1 to MU. The proposal would incorporate the new land into the larger Pinnacle Prairie Mixed Use District and update the master plan appropriately. She displayed a revised concept for Pinnacle Prairie East and the view of the area proposed for rezoning to MU and discussed the plans for those areas. She discussed the street network and traffic circulation as well as alternate routes and adjustments that may need to be made. Ms. Howard noted that a preliminary and final plat will be required prior to any land sales within the master planned area and a new developmental procedures agreement will need to be drafted and signed prior to setting a public hearing at City Council. Staff recommends approval of the request to rezone property from A-1 and R-1 to MU, and to update the Pinnacle Prairie Master Plan accordingly, subject to a new or amended development agreement that addresses the specific issues outlined in the staff report.

Carrie Hansen, Schoppe Design Associates, spoke about the connection of Prairie View out to Cedar Heights and the location of Huntington where the new roundabout is planned to go. She stated that if this is not possible they have agreed to relocate it to another portion of the proposed multi-family area. She noted that they have met their obligations for the Goldenrod and Prairie Parkway roundabout improvement that had been noted previously. They have also submitted a revised development procedures agreement that addresses many of the items in staff's report and will continue to work with staff to finalize those documents.

Mr. Holst made a motion to approve the item. Ms. Lynch seconded the motion. The motion was approved unanimously with 9 ayes (Hartley, Holst, Larson, Leeper, Lynch, Prideaux, Saul, Schrad and Sears), and 0 nays.

- 5.) The next item of business was zoning code text amendments relative to downtown character district regulations. Chair Leeper introduced the item and entertained a motion to move it to the end of the agenda.

Ms. Lynch made a motion to approve moving the item to the end of the agenda. Ms. Saul seconded the motion. All voted aye.

- 6.) The next item for consideration by the Commission was wheatpasting murals in the Central Business District Overlay. Chair Leeper introduced the item and Mr. Atodaria provided background information. He explained that there is a proposal the place temporary wheatpasting murals sourced from historic photographs at different locations downtown. The murals are based on cultural memory, family snapshots and ephemeral street art and will be made of biodegradable, non-destructive wheat pasting art that will not permanently alter the facades of the building. He displayed images that are proposed for the various locations. He noted that the propose façade plan meets all of the Central Business Overlay Zoning District and Zoning Ordinance requirements and would be a positive community building effort. Staff recommends approval.

Isaac Campbell, 2009 University Drive Apt G4, explained that this project is a main component of his masters thesis and that the photos are to explore what getting back together means post-Covid-19. It is also a community building effort to get people involved in volunteering to install the art on the buildings.

Mr. Schrad stated that he feels that this is a wonderful idea and asked if we could explore more photos with more diversity. Mr. Campbell noted that there was a conscious effort to include several images that show people of diverse backgrounds, but wished there could be more. He explained that the photos are provided from Fortepan Iowa that are collected on a donated basis. The project hasn't grown enough to provide many diverse images yet, but they are working to add those photos.

Ms. Saul asked how long the wheatpasted images last. Mr. Campbell explained that it varies depending on weather conditions and other environmental factors. In his experience they can last up to a year. He is confident they would last well through the summer and into the fall.

Mr. Leeper asked if there have been any discussion about permanent installations of this kind. Mr. Campbell noted that he has been asked that question and noted that this particular art form is temporary in nature. However, the project could be a catalyst to

build interest in more permanent murals in the downtown. He noted that a much of the benefit of the wheatpasting is the community building aspect and the social interaction that it generates.

Kim Bear, 3815 Union Road, spoke to show support of the project from Community Main Street.

Ms. Prideaux made a motion to approve the item. Mr. Schrad seconded the motion. The motion was approved unanimously with 9 ayes (Hartley, Holst, Larson, Leeper, Lynch, Prideaux, Saul, Schrad and Sears), and 0 nays.

- 7.) The Commission then considered a College Hill Neighborhood Overlay review for 704-706 W. 28th Street. Chair Leeper introduced the item and Mr. Sevy provided background information. He explained that the request involves a remodel on the above-mentioned property and gave a brief review of the intent and purpose of the overlay. The proposal is to add bedrooms and other appropriate updates with the intent to raise the rental occupancy by one bedroom per unit. He noted that a similar request to add bedrooms was considered several months ago. This proposal is to add 1 bedroom per unit versus adding 2 bedrooms. The applicant modified the request based on the denial of his last request, which was deemed too dense. The property currently provides sufficient parking if counted in tandem, which is allowed. He discussed the density of the project with respect to the density of surrounding properties and noted that it fits with the neighborhood. Staff recommends approval due to sufficient parking, and consistency with the intent of the College Hill Overlay and occupancy standards outlined in the rental code. Mr. Sevy noted that he received communication from two of the neighbors who were not in favor of the density increase, and a third felt that the occupancy should not be limited.

Wes Geisler, 5373 S. Hudson Road, stated that he feels that the proposed siding and exterior upgrades, as well as the new driveway and landscaping will add value to the neighborhood.

Mr. Schrad stated that he likes the changes that were made in compromise and that he is in favor of the project. Mr. Holst agreed.

Mr. Holst made a motion to approve the item. Ms. Saul seconded the motion. The motion was approved unanimously with 9 ayes (Hartley, Holst, Larson, Leeper, Lynch, Prideaux, Saul, Schrad and Sears), and 0 nays.

- 8.) The next item of business was a minor subdivision plat on Lot 2 of Blain's Corner 2nd Addition. Chair Leeper introduced the item and Mr. Atodaria provided background information. He explained that property is located at 219 Brandilynn Boulevard and that it is proposed to divide the parcel into two lots and build an Aldi's grocery store on the new lot. The introduction of this minor plat is for discussion and public comment purposes only at this time. Staff recommends approval with the stipulations that any comments or direction by the Commission are followed and that there is conformance with all city staff recommendations and technical requirements.

Ryan Anderson, Civil Engineer with ISG and project manager, stated that Aldi has been looking for another site in the area for a while and feels that it will be a nice partnership with Blain's. He made himself available for any questions.

As staff still has a few technical changes to work out with the applicant, the item was

continued to the next meeting.

- 9.) The Commission then considered a HWY-1 site plan for Aldi's grocery store. Chair Leeper introduced the item and Mr. Atodaria provided background information. He explained that the proposal is to develop a 20,299 square foot Aldi's grocery store which will be constructed on the new lot created with the Blain's Corner 2nd addition minor plat. He discussed the basic information regarding the site plan, including setbacks, access points, lot lines and the trash location. He explained the requirements with regard to parking and open/green space, as well as the proposed sidewalk and landscaping plans. Mr. Atodaria provided renderings of the proposed signage and where it would be located if approved, as well as the design review, which includes proportion, roof shape/pitch/direction, pattern, materials, color and architectural features. He discussed the technical comments that still need to be addressed by the applicant and noted that they believe they will be completed by the next Commission meeting. At this time the item is just for discussion and public comment.

Mr. Schrad asked if the proposed retention area meets the requirements for the square footage of the parking lot. Mr. Atodaria explained that it has been met.

Mr. Larson asked what the technical issues are that still need to be resolved. Mr. Atodaria explained that they include the trash enclosure, updating the labeling of the water main, and general engineering comments to be reflected on the plan. The Commission continued the discussion to the next meeting.

- 10.) Chair Leeper brought back the agenda item for the zoning code text amendments relative to downtown character district. Ms. Howard explained that the code has been available for public review for over a month, the Commission has reviewed the code during separate work sessions, and a number of emails and phone inquiries have been received from people within the study area. Staff and the consultants have highlighted any requests for amendments to the draft code in the decision matrix provided in the packet. Chair Leeper opened up the hearing to the public for comments.

Jessie Crisman, 1003 Main Street, asked for more clarification on how the properties will be impacted by changes being made to Main Street and the flow of traffic and how that will impact the safety of children in the neighborhood. Ms. Howard noted that the reconstruction of Main Street is not a part of zoning code changes, but with regard to the changes in the zoning code for that area, Ms. Howard explained that in that particular area would allow for a mix of uses like it does today, but it will also keep existing single-family houses conforming.

Melissa Sander, daughter of Joyce Anderson of 1117 Main Street, noted that her mother is concerned with the traffic coming from 12th Street, particularly with the high school nearby. She is also concerned with potential loss of parking. Mr. Leeper explained that the questions about the road are not part of the current discussion regarding rezoning. Those things are being discussed at City Council, but it isn't part of this discussion.

Jim Benda, 315 W. 2nd Street, stated that he would propose that commercial development be allowed for the entire block depth between 1st and 2nd Streets, because he is concerned that the area is too small otherwise for commercial development. He gave McDonald's as an example. Ms. Howard discussed the vision plan for that area and how the regulating plan does allow adjustments if needed to accommodate potential projects and discussed how the higher intensity Urban General does extend further into the block,

but designates the south sides of those blocks as Neighborhood frontage . She noted that this was one of the requests for amendments that is included in the decision matrix, so would be discussed in more detail later in the meeting.

Hillery Oberle, 2508 Franklin Street, voiced general support for the overall downtown zoning revision and applauds the effort that has been put into this process.

Kim Bear, Community Main Street, commended the City on the whole process and how citizens have been included in the progression of the updates.

As there were no more comments from the public, Ms. Howard displayed the matrix of proposed amendments for discussion and covered each item to allow for comment from the Commission.

The first item was a change to the building form standards to allow the private open area to be above grade for lots with less than 70' of depth. The Commission agreed that the change made sense.

The second item was a change to the required building line on the change of the Required Building Line (RBL) on the Downtown Regulating Plan, on the north side of W. 2nd Street from Franklin Street to the western border of the District. Staff/consultants recommend the RBL should be moved forward an additional 5 ft. from 15 ft. to 10 ft. off the front property line to allow for redevelopment on these shallow depth lots. The Commission agreed that the change made sense.

The next item was to insure consistency of terms between the new proposed Section 26-140 and proposed Section 26-197, as well as clarifying language in Character District Use Table introductory paragraph concerning additional standards that apply. This will essentially make the terms match in each Section. The Commission was in agreement with the changes.

The fourth item was to correct the outline format as needed throughout the document. The Commission agreed.

The fifth item was a request from the Historical Society to add them as a Civic Building designation in the Regulating Plan. Staff is also looking to change other similar buildings to that designation as well. The Commission agreed with the changes.

The next item was a change to Section 26-140 to distinguish between small and large commercial assembly uses in the use classification section. The Commission agreed with this change.

The seventh item was to change the Regulating Plan designated building frontage on west side of Overman Park from Neighborhood small to Urban General 2 to accommodate existing businesses located along Franklin Street. Or alternatively, a request from Tom and Dorinda Pounds who would like assurance that their business can continue, but that the home could also be converted back to residential use in the future should that be desired. They would like an approach that would better accommodate existing businesses while maintaining the residential character and scale of the area. Staff suggests adding language to state that all existing businesses in the Neighborhood frontages at the time of Code adoption would be considered conforming, however no new businesses would be permitted. The Commission agreed to Option 2 as outlined in the matrix.

The eighth item includes a design review process or role for the Planning and Zoning Commission. Ms. Howard discussed the pros and cons of the additional guidance proposed. Staff/consultants are not recommending adoption of a public design review process at this time. Mr. Larson would like to know more about the staff body that would be doing the architectural review and how the process works. Ms. Howard described the review process and the zoning review committee and the intent to assist developers in ensuring development projects meet all the new standards in the code. She noted that the committee can also consult with any other technical staff as needed and site plans would have to go through the Technical Review process as well. The Zoning Review Committee includes the planning manager, building official and a planner. She noted that this was a major goal of the zoning update to create a code that has clear and objective standards – to get rid of the gray area in the code, so projects could be reviewed administratively and to streamline the development review process. Ms. Saul asks what happens if someone doesn't like the project. Ms. Howard stated that the code is clear and objective on standards so the staff has to follow those standards. There is not a lot of discretion with the new standards. Mr. Leeper noted that he would like to see some kind of process to be available to staff to send to the Commission to review and to approve or disapprove a project when something doesn't seem right. There was more discussion by the Commission on the pros and cons of requiring this extra design review process. Director Sheetz noted that there were quite a few zones in the City where site plans are approved administratively already. There was further discussion on the matter and it was decided to keep the draft the same without a legislative review process and see how it works over time, noting that it could be reconsidered in the future if additional layer of review is needed.

Item nine was brought forward by Kevin Harberts who owns properties along 2nd Street. It is to change the Regulating Plan so that the General Urban frontage designation goes from the 1st Street frontage to 2nd Street frontage. The requestor would like the option to create larger through lots for commercial uses that extend the full depth of the block from 1st to 2nd Streets. Ms. Howard noted that this was what Mr. Benda was also requesting earlier in the meeting. The pros and cons were discussed. Staff/consultants do not recommend this change as it would create a poor transition to the residential neighborhood along 2nd Street and would not be consistent with the adopted Downtown Vision Plan, which illustrated how this transition could be accomplished. The regulating plan already allows deeper space to accommodate commercial redevelopment along 1st Street. The Commission agreed that there should be no change to the regulating plan.

The next item was to consider the inclusion of vinyl siding as an approved wall material in neighborhood frontages. The pros and cons were discussed and options were given for alternative siding choices and the Commission had a great deal of discussion. The Commission came to a consensus to move forward with the first, second and third options noted on the decision matrix:

1. Maintain the prohibition of vinyl siding for new construction
2. Permit the use of vinyl siding to replace or repair existing vinyl siding and for additions to existing buildings that already have vinyl siding.
3. Permit use of vinyl siding that meets higher minimum standards for quality, maintenance, and durability, based on industry standards to replace or cover over other types of siding on existing single-family dwellings.

The next item that was considered was lifting the prohibition of using higher quality foam products for architectural detail. Ms. Howard explained that the verbiage could be updated

to allow for that kind of foam and the staff/consultants felt that would be appropriate. The Commission agreed.

The 12th item on the draft review was the provision of more direction on ADU's. After brief explanation, the commission agreed with this change.

The final item was the prohibition of conversion of existing single unit dwellings into duplexes or multi-unit dwellings, similar to the current prohibition in the R1 and R2 Zones. Staff recommends this change in order to help stabilize these neighborhoods, while allowing new housing types that meet all the new standards in the code. There was brief discussion and the Commission agreed with making this change.

Mr. Leeper asked what the next steps would be. Howard explained that the Commission could continue the hearing as long as they feel is needed to cover any questions or suggestions for changes to the draft. She noted that staff anticipated that at least one additional meeting would be warranted and then if no further changes or discussion was needed, the Commission would make a recommendation to Council. In response to a question, she noted that variety of notifications and press releases have gone out to keep the public informed of the opportunity to participate.

- 11.) As there were no further comments, Mr. Holst made a motion to adjourn. Ms. Saul seconded the motion. The motion was approved unanimously with 9 ayes (Hartley, Holst, Larson, Leeper, Lynch, Prideaux, Saul, Schrad and Sears), and 0 nays.

The meeting adjourned at 8:00 p.m.

Respectfully submitted,

Karen Howard
Community Services Manager

Joanne Goodrich
Administrative Assistant

Cedar Falls Planning and Zoning Commission Work Session

**March 17, 2021
City Hall via Videoconference
Cedar Falls, Iowa**

The Cedar Falls Planning and Zoning Commission met in special work session on March 17, 2021 at 7:00 p.m. by videoconference. The following Commission members were present: Hartley, Holst, Larson, Saul, and Schrad. Leeper, Lynch, Prideaux and Sears were absent. Stephanie Houk Sheetz, Director of Community Development, Karen Howard, Community Services Manager, and Thom Weintraut, Planner III, were in attendance. Elizabeth Garvin and Mary Madden, both consultants, were also present.

Mr. Larson opened the work session. Ms. Howard noted that a hard copy of proposed new code was provided to each Commissioner and explained that the staff broke down the review of code into four work sessions.

Ms. Garvin gave an overview of the organization of the uses into larger categories. She also stated there is a process provided for identifying uses that are not easily identified in a use category. If a new use is proposed that does not fit into one of the proposed categories, the process would be to do a zoning code update to add the use to a category.

Ms. Saul asked who the Zoning Administrator is. Ms. Howard stated the Planning and Community Service Manager is the Zoning Administrator.

Ms. Saul asked about the Zoning Review Committee and the Technical Review Committee. Ms. Howard stated these are staff committees to review development applications to ensure compliance with the code. The staff is also there to help applicants understand the code and help address any issues that arise.

Ms. Saul asked what would be the role of the Planning and Zoning Commission when the new code is adopted. Ms. Garvin stated the role of the Commission is as a recommending body to the City Council for larger legislative decisions such as rezonings, changes to the zoning code, and consideration of comprehensive and neighborhood plans.

Ms. Garvin explained the larger categories of uses; Residential, Civic and Institutional, Commercial, Industrial, Transportation and Utilities, and Agriculture. Each Category will have a description and will be broken down into subcategories. Ms. Howard stated by adding the classifications, it will make managing the code easier and will provide a tie to the character districts.

Mr. Larson asked if the use categories pertaining to Downtown Code and future updates have to be adjusted within each Character District to insure the uses are adaptable and not be rendered non-conforming. Ms. Garvin stated the intent is not to make any properties nonconforming and as the development of other sections are being done, there will be cross referencing of each section to insure the Code aligns across all sections and creates the least amount of change, unless change is desired.

Mr. Larson – Will there be a process for public outreach similar to the Downtown and College Hill changes for the rest of the code update? Ms. Howard stated there would be a process, but it may not be the same for all areas of the city as form based districts may not work well for all areas. Staff will look to City Council for guidance.

Mr. Larson asked if there are any specific properties in the Downtown that might be made non-conforming. Ms. Fadden stated consideration was made for Viking Pump and a section was added for industrial uses allowing existing industrial to remain but no new industrial uses would be allowed. Ms. Howard stated another category was auto repair services. Ms. Fadden also pointed to the section pertaining to the Shopfront frontages along the Parkade and stated these should be active space in the front 30 feet of the space, but other uses such as office spaces could be located behind in the interior of the lot.

Ms. Saul stated there are buildings along the Parkade that don't meet the Shopfront requirements and what would happen if the building is sold? Ms. Fadden stated as long as there were no changes to the use or the exterior facades, they would be grandfathered and may continue as they are now. If changes are proposed then there are standards that apply proportionally to the changes to a building.

Ms. Garvin stated the code has an administration section, which codifies the procedure for reviewing site plans, including consideration of whether a project submittal meets the submittal requirements. The section also lets an applicant know what can be expected as part of the review process and how the process moves forward. This section spells out the application procedures, the decision criteria, and clarifies that zoning approval does not imply approval by any other City departments. Site plans are binding to a property and site plan approval expires after one-year.

Ms. Saul if there were projects that were previously approved but never constructed, what is the process for completion? Ms. Howard stated currently site plans do not expire.

Mr. Larson asked why one year. Ms. Garvin stated one year is usually sufficient to get financing, all necessary permits and begin construction. She added there is a mechanism to allow applicants to request a one-year extension. Ms. Howard said the intent is to keep projects current in the event the code changes.

Mr. Larson asked what the timeline is for preliminary plat approval. Ms. Howard stated it was two years. Mr. Larson asked if site plan approval could follow a similar approval period. Ms. Howard state these are two different processes. Ms. Garvin responded that an applicant would just need to obtain a building permit to meet the approval time period. Howard clarified that the project does not have to be constructed within a year, the applicant just needs to get a building permit approved.

Mr. Holst asked if the administrative review process would reduce the number of site plan coming to the Commission. Ms. Howard confirmed that it would.

Ms. Garvin explained the process of the proportionate compliance when a building in the downtown is being altered structurally. New construction would be required to meet the standards, but if an addition is proposed, there are different thresholds of development which would determine what standards would be met. Maintenance and minimal changes to a façade would not trigger compliance with the standards.

Ms. Saul asked how historic character requirements play into the new Code. Ms. Howard stated the intent of this process would require an applicant who wished to change the character of a façade to go through a review process for approval. Mr. Schrad asked if these regulations would impact Historic Preservation requirements. Ms. Howard stated there is nothing in the proposed code that would be contradictory to the Department of Interior standards.

Ms. Garvin presented information on the section regarding minor adjustment to the Code and the standards which are consider for an adjustment, such as setbacks for elements, adjustments for equivalent or better quality materials, and access issues for properties that cannot obtain access from an alley. Decision criteria are included for granting a minor modification to help outline the process.

Mr. Larson asked about material requirements and was concerned the residential areas are not allowed to use vinyl siding as a material. Ms. Fadden stated this requirement was a starting point based on input from the community, but the Commission can consider other requirements. Mr. Larson said consideration should be made additions to an existing building with vinyl siding because it could impact property rehabilitation. Mr. Schrad also stated concern about a prohibition on vinyl siding may impact on whether a property owner choses to improve the exterior of a building. Ms. Howard stated further discussion should be made regarding allow building materials.

Mr. Larson had a question regarding the use of the word alteration. Ms. Fadden stated the intent was to allow the replacement of materials as part of maintenance and not changing the openings or proportions.

Mr. Larson asked about the ten year timeline and how to track cumulative changes and if it applies to the current owner or subsequent owners. Ms. Fadden stated that it would apply to property, not owner specific.

Mr. Larson asked if the sale of a property terminated a non-conforming use. Ms. Howard stated if a building changes hands, but the use continues, it would be grandfathered in as non-conforming. Ms. Fadden mention if a use is abandoned for a period of six months the property has to be brought into compliance with use.

Ms. Saul asked Mr. Holst, as an architect, his thoughts on the proposed code. Mr. Holst replied he in general it was good. Ms. Howard stated someone from Mr. Holst office was part of a workshop group of profession to gather thoughts on the plan and someone from Mr. Holst office brought up an exterior foam material, Fypon, which is a quality product. Ms. Howard state this material change has been placed that on the City's list of changes to the Code.

Ms. Howard encouraged the Commission to continue to review and provide thoughts or comments.

Respectfully submitted,

Karen Howard
Planning & Community Services Manager

Thomas A. Weintraut, Jr.
Planner III



DEPARTMENT OF COMMUNITY DEVELOPMENT

City of Cedar Falls
 220 Clay Street
 Cedar Falls, Iowa 50613
 Phone: 319-273-8600
 Fax: 319-273-8610
 www.cedarfalls.com

MEMORANDUM

Planning & Community Services Division

TO: Planning and Zoning Commission
FROM: Jaydevsinh Atodaria (JD), Planner I
 Ben Claypool, PhD, EI, Civil Engineer II
DATE: April 22, 2021
SUBJECT: Blain's Corner 2nd Addition Minor Plat

REQUEST: Request to approve the Blain's Corner 2nd Addition Minor Plat
 (Case # MP21-001)

PETITIONER: Davenport Farm and Fleet INC, Owner; Andrea Rand (ISG), Engineer

LOCATION: 219 Brandilynn Blvd

PROPOSAL

The current property owner of the lot addressed as 219 Brandilynn Blvd. proposes to divide the property into two commercial lots, which will convert the existing lot into two commercial developable lots. The application intends is to subdivide the existing parcel in Blain's Subdivision into two lots and develop the newly created lot by proposing a new Aldi grocery store. A minor plat is required to split the original single lot into two lots. The subject parcel is within the HWY-1 Highway Commercial Zoning District.

BACKGROUND

The parcel was created by Blain's Corner Addition to Cedar Falls, Iowa in 1998. As shown below, the subject parcel to be divided is the Blain's Farm and Fleet store which sits on Lot 2 of Blain's Addition, which is now the only parcel in the subdivision. Over time there have been a lot of reconfigurations of lots in this subdivision. Lot 1 of original Blain's addition is now called as T & L Plaza addition and has been further divided into 4 lots. And Tract B of the original Blain's addition is now owned by the City of Cedar Falls and is being operated as a public street.

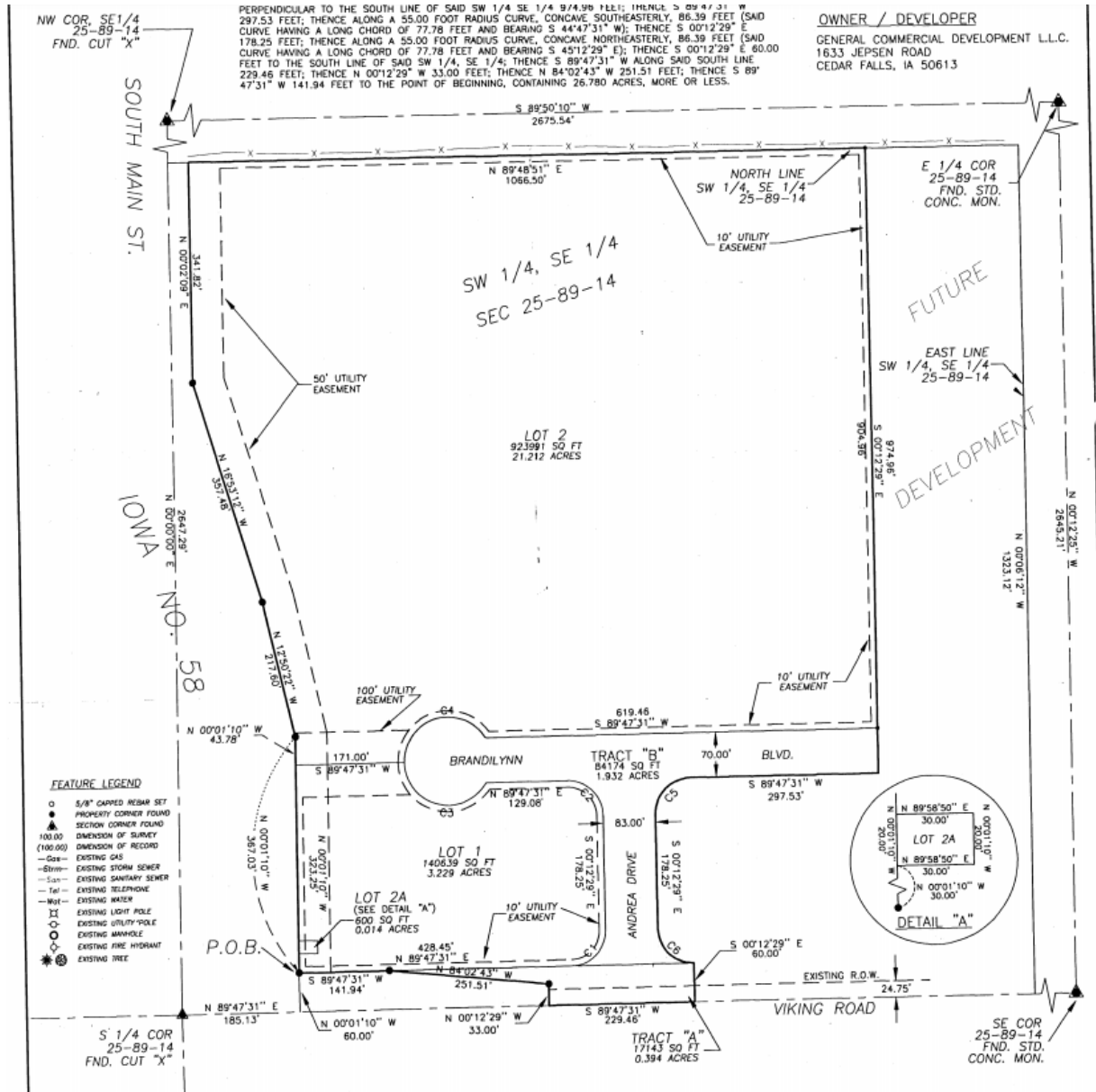

Applicant requests dividing the only remaining lot in the Blain’s Corner Addition into two parcels which will allow Blain’s Farm and Fleet store to continue operating on one lot and proposes to develop the other lot by adding a new Aldi’s grocery store.

ANALYSIS

219 Brandilynn Blvd property is located in the HWY-1 Highway Commercial Zoning District. Currently the lot measures approx. 21.21 acre which houses Blain’s Farm and Fleet. With the proposal of a minor plat, this lot will be divided into Parcel V (16.46 acres approx.) and Parcel W (4.41 acres approx.) Parcel V will continue the use of the site with Blain’s Farm and Fleet and the applicant proposes to put a New Aldi’s store in the newly created Parcel W. Currently, Blain’s site is accessed by three access points through Brandilynn Blvd. and to provide access to the newly created Parcel W (or New Aldi’s building), there will be a shared access agreement over the eastern entrance to the lot. There will be a shared access easement to allow ingress/egress to the newly created parcels.

The drawing below graphically depicts the lot split and building locations. The building setbacks in the HWY-1 Highway Commercial Zoning District require a 20-foot setback consisting of landscape material that shall be established around the perimeter of the district. No interior side setback is enforced when two buildings are side by side. The setback in the proposed plat does meet the City's Zoning Code requirement. However, the applicant also proposes 10 feet setback from the shared side lot line, placing the new proposed building at 20 feet from the existing Blain's Farm and Fleet building. The proposed minor plat includes a private access easement that would allow access to the newly created Parcel W. Proposed minor plat also corresponds to 10 feet utility easement along the south, east and north property line as per the original Blain's addition. Besides, the proposed plat includes a public sidewalk easement along the north property line that would allow the addition of 5 feet wide public sidewalk extending eastward to the eastern lot line of the plat from the existing Cedar Prairie Trail.

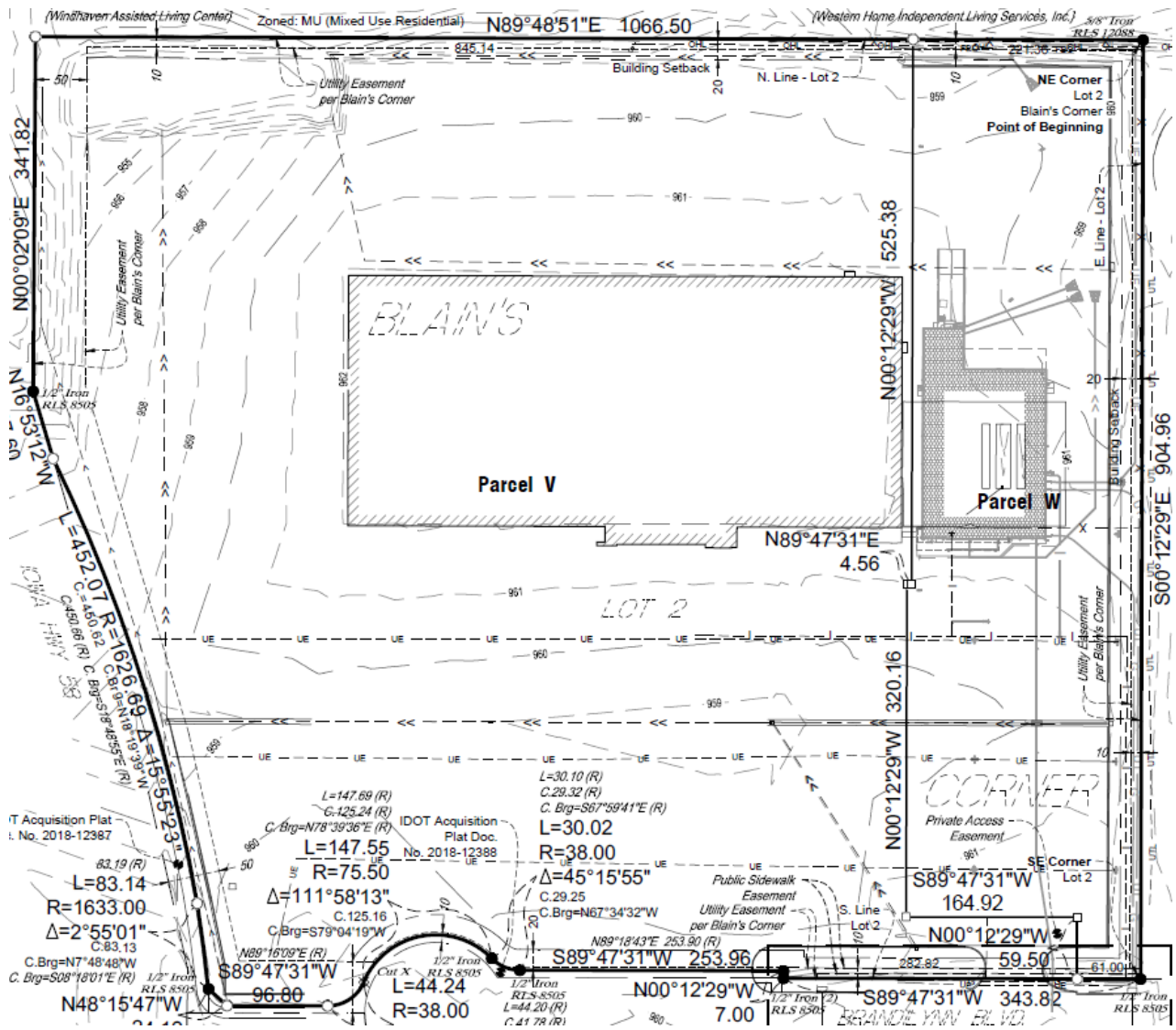

New proposed Aldi's building and lot size will be a lot smaller in the area as compared to the Blain's building and site area. And the two newly created parcels V and W both meet all the zoning ordinance requirements.

TECHNICAL COMMENTS

Cedar Falls Utilities (CFU) has reviewed the Minor Plat Hwy 1 Site Plan for the proposed Aldi's.

Water, electric, gas, and communications utility services are available in accordance with the service policies of CFU. Water is available from a privately owned 12” water main in front of the proposed Aldi’s that serves two fire hydrants, one on the east side and one on the south side of Blain’s. The plat shows 10 feet wide utility easement along the south and east property line, shows 5 feet wide Public Sidewalk easement along the south property line, and a private access easement along the south-east corner of the plat to provide access to Aldi’s site (Parcel W) from Blain’s lot (Parcel V) through Brandilynn Blvd.

The property is located outside the floodplain overlay district.

City staff has attached the revisions to Minor Plat but notes that some minor corrections are still pending. As per the applicant, the staff will get the revisions as requested before the Planning and Zoning Meeting. Staff also has attached the draft for the deed of dedication for review. City staff notes that language about adding a public sidewalk bordering the south lot line of Parcel V and Parcel W be added as public improvements and language about public sidewalk easement be added in the deed of dedication. City staff notes that all the legal documents of the Minor plat will be required signed and stamped as per the application checklist and subdivision code requirements before taking the case to City Council.

A courtesy mailing was sent to the neighboring property owners on April 6, 2021

STAFF RECOMMENDATION

The Community Development Department has reviewed the proposed Minor case #MP21-001, and recommends approval with the following stipulations:

1. Any comments or direction specified by the Planning and Zoning Commission.
2. Conformance with all city staff recommendations and technical requirements.

Staff notes that the case if approved tonight by the Planning and Zoning Commission, the case will be presented to the City Council, once staff receives all the legal paper work with required signatures and stamps.

PLANNING & ZONING COMMISSION

Discussion 4/14/2021 Chair Leeper introduced the item and Mr. Atodaria provided background information. He explained that property is located at 219 Brandilynn Boulevard and that it is proposed to divide the parcel and build an Aldi store. The introduction of this minor plat is for discussion and public comment purposes only at this time. Staff recommends approval with the stipulations that any comments or direction by the Commission are followed and that there is conformance with all city staff recommendations and technical requirements.

Ryan Anderson, Civil Engineer with ISG and project manager, stated that Aldi has been looking for another site in the area for a while and feels that it will be a nice partnership with Blain’s. He made himself available for any questions.

As staff still has a few technical changes to work out with the applicant, the item was continued to the next meeting.

Discussion & Vote
4/28/2021

Cedar Falls Planning and Zoning Commission

April 28, 2021

Item 3.

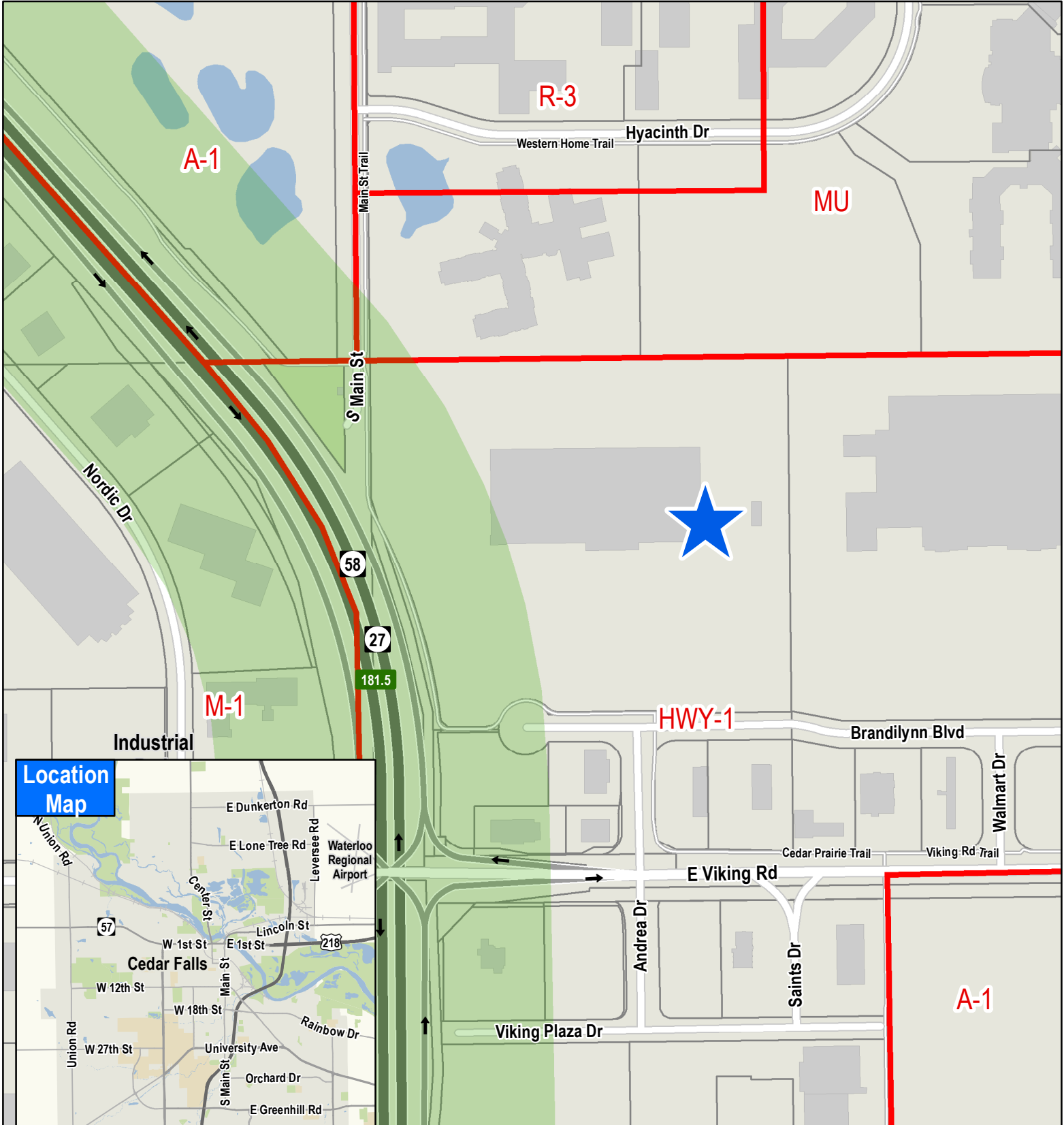

Location Map

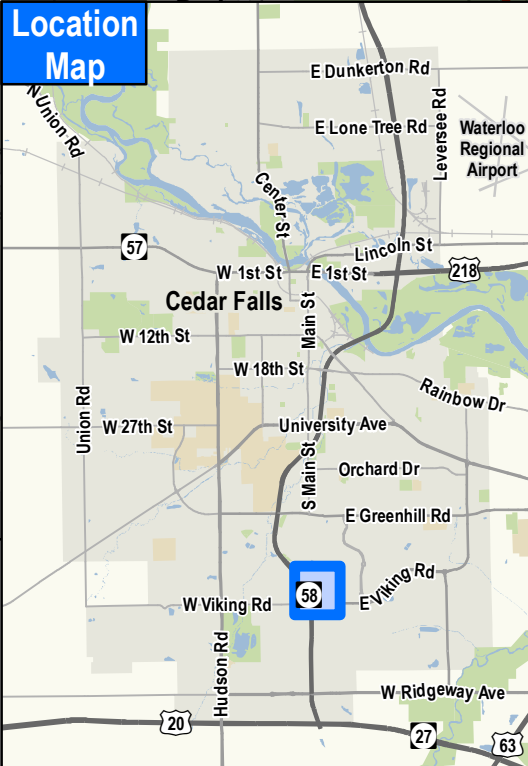

**Blain's Corner 2nd Addition Minor Plat
219 Brandilynn Blvd.**

INDEX LEGEND
PLAT OF SURVEY
GENERAL DESCRIPTION: Part of Lot 2, Blain's Corner, Cedar Falls
PROPRIETOR: Davenport Farm and Fleet, Inc.
PLAT PREPARED FOR: Aldi, Inc.
PLAT PREPARED BY: Daniel L. Stueber
COMPANY NAME: ISG
OFFICE ADDRESS: 115 E. Hickory St. Suite 300 Mankato, MN 56001
PHONE: 507-387-6651

PLAT OF SURVEY

BLAIN'S CORNER 2ND ADDITION MINOR SUBDIVISION PLAT

Part of Lot 2, Blain's Corner
Cedar Falls, Iowa
Black Hawk County, Iowa

NOTES:

- The basis of bearing for this Plat of Survey is the east line of Lot 2, Blain's Corner, said line bears South 00 degrees 12 minutes 29 seconds East.
- Owner/Subdivider:
Davenport Farm and Fleet, Inc.
PO Box 5391
Janesville, WI 53547
- Zoning: HWY-1 (Highway Commercial District)
Setbacks
Building
Front - 20 feet
Side - 20 feet (City staff indicated no interior side setbacks enforced)
Rear - 20 feet
- The error of closure is better than 1:10,000
- Address of Parcel V - 219 Brandilynn Blvd.

AREA TABLE

Parcel V: 716,932 sq. ft. - 16.46 acres
Parcel W: 192,247 sq. ft. - 4.41 acres

This plat or Subdivision has been reviewed by the City of Cedar Falls, Iowa.

LEGAL DESCRIPTION PARCEL V:

Lot 2, Blain's Corner to Cedar Falls, Black Hawk County, Iowa, except that part conveyed to the State of Iowa in Doc. #2018-12387 and except that part conveyed to City of Cedar Falls in Doc. #2018-12388

ALSO EXCEPT

That part of Lot 2, Blain's Corner to Cedar Falls, Black Hawk County, Iowa, described as follows:

Beginning at the northeast corner of said Lot 2; thence South 00 degrees 12 minutes 29 seconds East (assumed bearing) on the east line of said Lot 2, a distance of 904.96 feet to the southeast corner of said Lot 2; thence South 89 degrees 47 minutes 31 seconds West on the south line of said Lot 2, a distance of 61.00 feet; thence North 00 degrees 12 minutes 29 seconds West, 59.50 feet; thence South 89 degrees 47 minutes 31 seconds West, 164.92 feet; thence North 00 degrees 12 minutes 29 seconds West, 320.16 feet; thence North 89 degrees 47 minutes 31 seconds East, 4.56 feet; thence North 00 degrees 12 minutes 29 seconds West, 525.38 feet to a point on the north line of said Lot 2; thence North 89 degrees 48 minutes 51 seconds East on said north line, 221.36 feet to the point of beginning.

LEGAL DESCRIPTION PARCEL W:

That part of Lot 2, Blain's Corner to Cedar Falls, Black Hawk County, Iowa, described as follows:

Beginning at the northeast corner of said Lot 2; thence South 00 degrees 12 minutes 29 seconds East (assumed bearing) on the east line of said Lot 2, a distance of 904.96 feet to the southeast corner of said Lot 2; thence South 89 degrees 47 minutes 31 seconds West on the south line of said Lot 2, a distance of 61.00 feet; thence North 00 degrees 12 minutes 29 seconds West, 59.50 feet; thence South 89 degrees 47 minutes 31 seconds West, 164.92 feet; thence North 00 degrees 12 minutes 29 seconds West, 320.16 feet; thence North 89 degrees 47 minutes 31 seconds East, 4.56 feet; thence North 00 degrees 12 minutes 29 seconds West, 525.38 feet to a point on the north line of said Lot 2; thence North 89 degrees 48 minutes 51 seconds East on said north line, 221.36 feet to the point of beginning.

VICINITY MAP

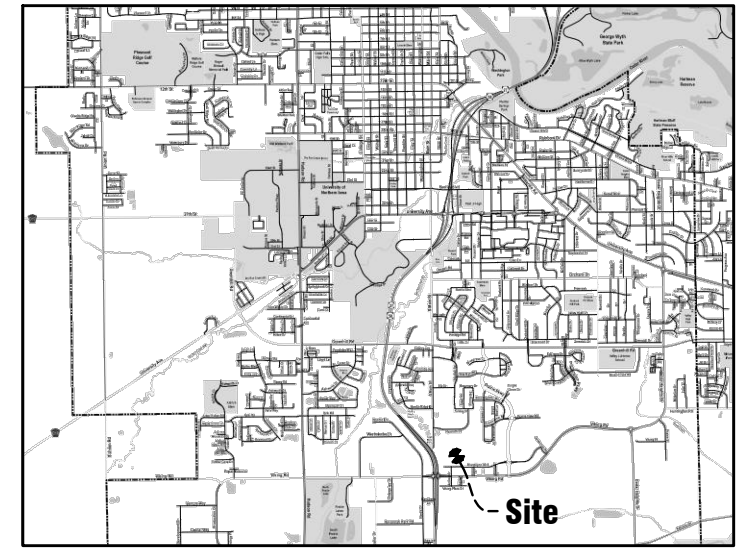

Cedar Falls, Iowa

Signature of City of Cedar Falls Zoning Ordinance Administrator _____ Date _____

DETAIL
1"=60'

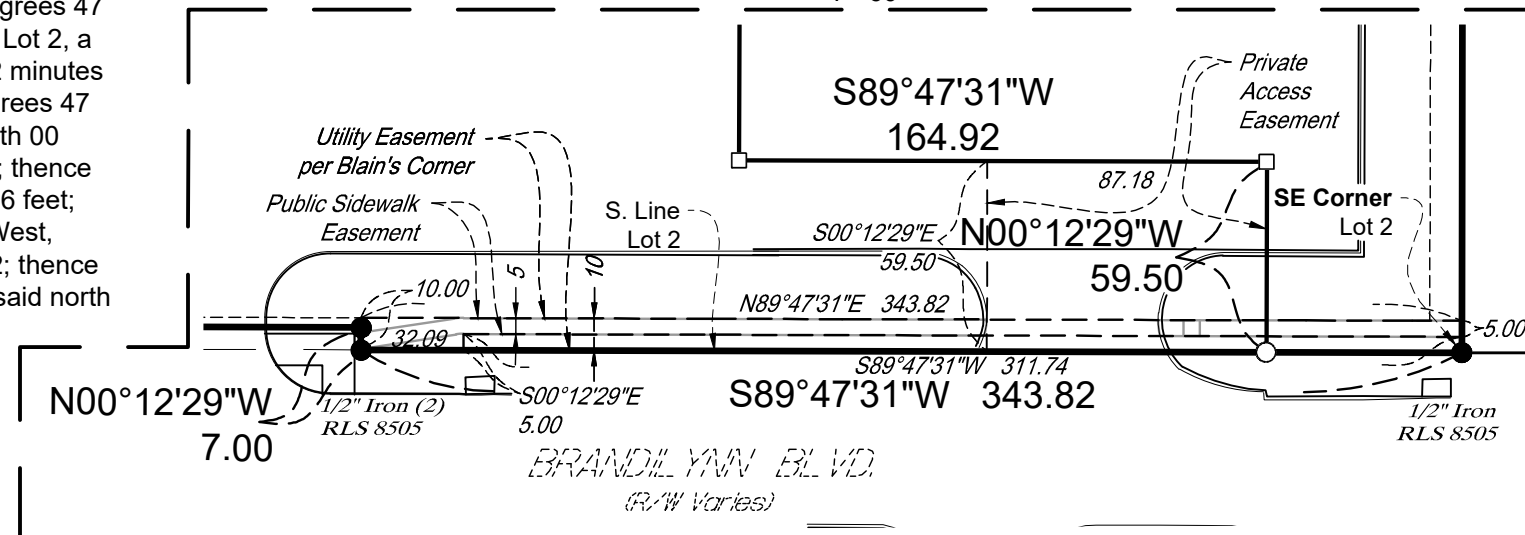

I hereby certify that this land surveying document was prepared by me and the related survey work was performed by me or under my direct personal supervision and that I am a duly licensed Land Surveyor under the laws of the State of Iowa.

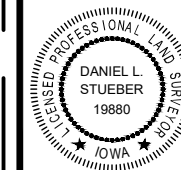

DLS
DANIEL L. STUEBER Date: 2/18/21
License Number 19880
My License renewal date is 12/31/21
Pages covered by this seal 3

ISG
PN: 16-19997
Sheet 1 OF 3
Surveyed by: DLS
Survey Date: 2/18/21
Rev. Date: 4/20/21

DRAWN BY: KJ CAD FILE NAME: 188P.PLT PLOT DATE: 4/20/21

PLAT OF SURVEY BLAIN'S CORNER 2ND ADDITION MINOR SUBDIVISION PLAT

Part of Lot 2, Blain's Corner
Cedar Falls, Iowa
Black Hawk County, Iowa

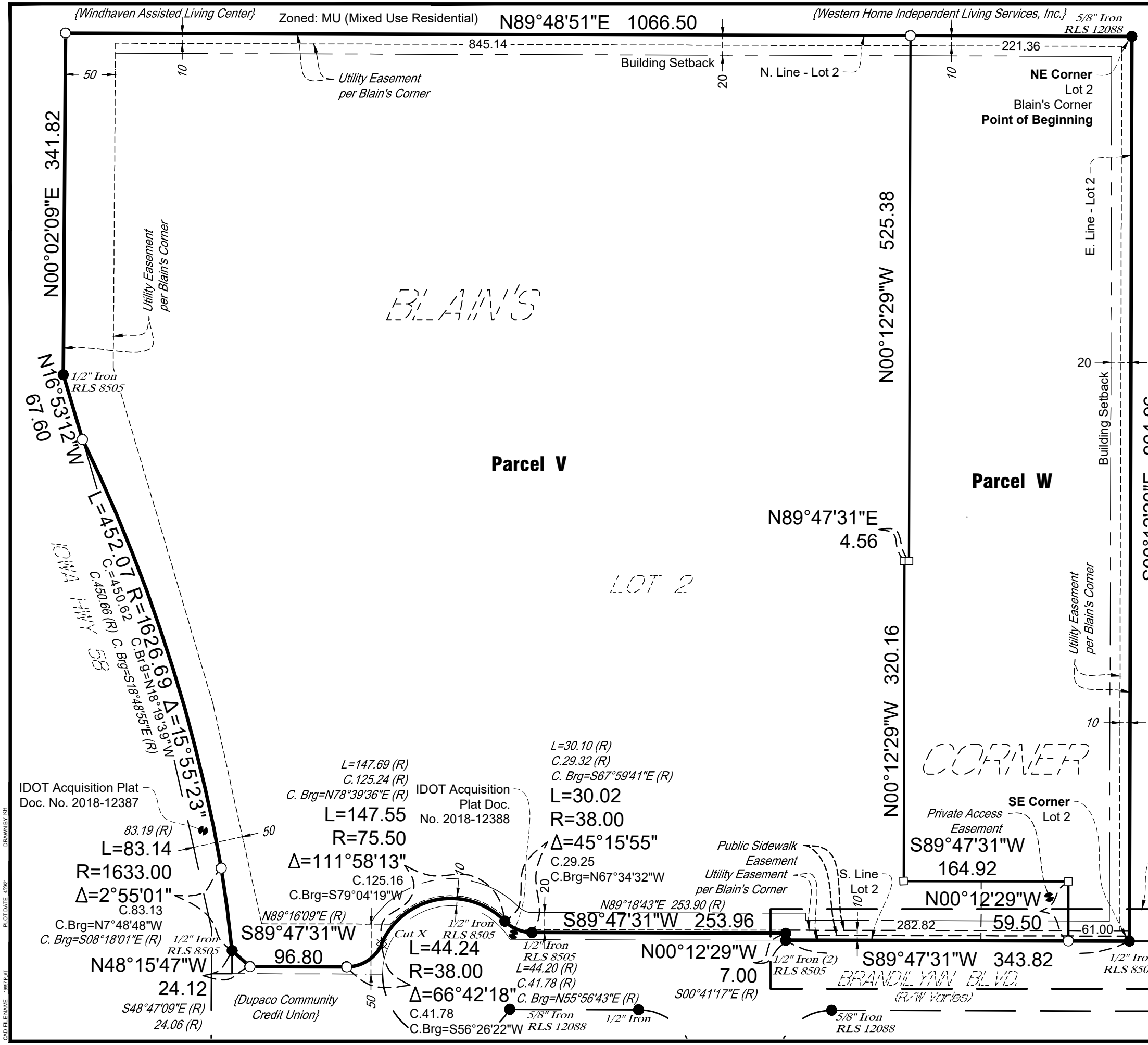
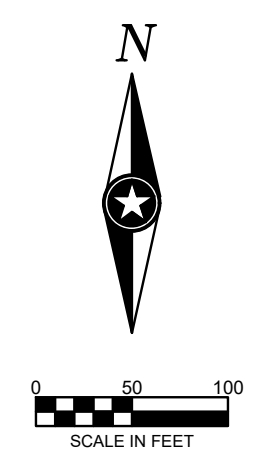

GENCOM
LOT 5
ADDITION

SEE DETAIL SHEET 1

LEGEND OF SYMBOLS/ABBREVIATIONS	
●	CORNER FOUND (monuments as described)
○	CORNER SET (1/2" iron w/gpc no. 19880)
□	CORNER SET (magnetic nail)
▲	SECTION CORNER FOUND (monuments as described)
100.00	MEASURED
100.00 (R)	RECORD
gpc	GREEN PLASTIC CAP

ISG

PN: 16-19997
Sheet 3 OF 3
Surveyed by: DLS
Survey Date: 2/18/
Rev. Date: 4/20/21

DRAWN BY: K4
PLOT DATE: 4/20/21
CAD FILE NAME: 1999.PLT

Prepared by and return to:
Kooperman Mentel Ferguson Yaross
100 S. Fourth Street, Suite 100
Columbus, Ohio 43215
Attn.: Ryan Crossley, Esq.

EASEMENT AND RESTRICTION AGREEMENT

THIS EASEMENT AND RESTRICTION AGREEMENT (this "**Agreement**") is executed, delivered and made effective as of this ____ day of _____, 2021 (the "**Effective Date**"), by and between **Davenport Farm & Fleet, Inc.**, an Iowa corporation ("**DFF**"), and **Aldi Inc.**, an Illinois corporation ("**Aldi**").

Background Information

A. Aldi and DFF each own certain parcels of real property located on Brandilynn Boulevard, Cedar Falls, Iowa. A copy of a site plan that generally depicts the properties owned by each of the Parties is attached hereto and made a part hereof as **Exhibit A**.

B. Aldi’s parcel, containing approximately 4.39 acres and located at 219 Brandilynn Boulevard, Cedar Falls, Iowa, is more particularly described on **Exhibit B**, attached hereto and made a part hereof (the "**Aldi Property**").

C. DFF’s parcel, containing approximately ____ acres located adjacent to the Aldi Property, and located at _____ Brandilynn Boulevard, Cedar Falls, Iowa and is more particularly described on **Exhibit C**, attached hereto and made a part hereof (the "**DFF Property**"; collectively, the Aldi Property and the DFF Property are sometimes referred to as the "**Properties**" and individually sometimes as a "**Property**").

D. In order to provide for, among other things, the coordinated development and operation of the Properties, the Parties have agreed to grant to the other certain easements upon

the terms and conditions specifically provided for herein. In addition, the Parties have agreed to subject the DFF Property to certain restrictions on use and development, as hereinafter set forth.

AGREEMENT

NOW, THEREFORE, in consideration of the premises, as set forth in the foregoing Background Information, and of the mutual promises herein set forth, and other good and valuable consideration paid, the Parties do hereby agree as follows:

ARTICLE I
Easements

1.01. Ingress/Egress Easement to Aldi. Subject to the terms and conditions set forth in this Agreement, DFF hereby grants and conveys to Aldi and its successors and assigns (including without limitation Aldi's employees, agents and customers), as a perpetual, non-exclusive easement from DFF, appurtenant to and for the benefit of the Aldi Property, over and across the driveways and walkways on the DFF Property identified as the "**Critical Access Drives**" depicted on **Exhibit A**, which pursuant to the terms of this Section 1.01 DFF shall not materially alter or relocate without the prior written consent of Aldi, such consent not to be unreasonably withheld), for the purpose of vehicular (including Aldi's delivery tractor trailers) and pedestrian ingress, egress and access between and among the Aldi Property, the DFF Property and the public roads. DFF shall have the right to relocate the Critical Access Drives upon no less than thirty (30) days' prior written notice to Aldi, provided that DFF at all times provides substantially similar and reasonably direct, paved access to and from the Aldi Property and the DFF Property and public roads. Notwithstanding the foregoing to the contrary, use of the DFF Property by Aldi's tractor trailers shall be limited to the area shown on **Exhibit A**, which for avoidance of doubt shall be the western most curb cut onto Brandilynn Boulevard and the portion of the DFF Property between such curb cut and the Aldi Property;

1.02 Ingress/Egress Easement to DFF. Subject to the terms and conditions set forth in this Agreement, Aldi hereby grants and conveys to DFF and its successors and assigns (including without limitation DFF's employees, agents and customers), as a perpetual, non-exclusive easement from DFF, for the benefit of and appurtenant to the DFF Property, over and across the driveways and walkways that are situated on the Aldi Property, for the purpose of vehicular and pedestrian ingress, egress and access between and among the Aldi Property, the DFF Property and the public roads.

1.03 Utility Easement to Aldi. Subject to the terms and conditions set forth in this Agreement, DFF hereby grants and conveys to Aldi and its successors and assigns, as an easement appurtenant to the Aldi Property, a non-exclusive easement over, under and across the DFF Property as may be necessary for the purposes of installing, using, maintaining, repairing and replacing service lines, connections and related improvements to provide utility services to the Aldi Property. Any such utilities infrastructure shall be installed, maintained, and operated by Aldi at Aldi's sole cost and expense, while minimizing disruption to the Aldi Property. Aldi shall at its sole cost restore any portion of the DFF Property disturbed by the exercise of such rights to the condition existing prior to such entry.

1.04. Sign Easement to Aldi. Subject to the terms and conditions set forth in this Agreement, DFF hereby grants and conveys to Aldi and its successors and assigns, as an

easement appurtenant to the Aldi Property, a perpetual right to (a) alter DFF’s shared sign in the general location shown on **Exhibit A** (the “**Shared Pylon Sign**”) as necessary to accommodate Aldi panels, and (b) install on the Shared Pylon Sign, Aldi’s two sided panels and the right to maintain, repair and replace such panels as determined necessary by Aldi. The panels to be installed on Shared Pylon Sign, as well as any modifications to Shared Pylon Sign necessary to permit the installation of such panels, shall be subject to the prior review and approval of DFF, and shall be of the same quality, nature, and appearance as the remainder of Shared Pylon Sign and shall not be modified or altered without the prior written consent of DFF, which shall not be unreasonably withheld, conditioned or delayed. Any modifications to Shared Pylon Sign, the two-sided panels, and any maintenance, repair, or replacement to the modifications to Shared Pylon Sign and Aldi’s panels shall be at Aldi’s sole cost and expense.

1.05 No Build Area. A perpetual, non-exclusive easement and restriction over and across (1) the DFF Property for the benefit of the Aldi Property and (2) the Aldi Property for the benefit of the DFF Property, for the purpose of maintaining the visibility of each party’s respective Property, whereby the area generally depicted on **Exhibit A**, as the “**No Build Area**” shall be restricted against future construction of or use for any above ground improvements except for curbs, sidewalks, light poles, paving, signage, landscaping and street signage, all of which shall be located to reasonably avoid or limit the obstructions to the view of each respective building from adjacent public roads. Further, except in the case of an emergency or necessary maintenance or repairs, no material construction activity shall occur on the exterior of the Aldi Property during the months of November, December or January if such work would interfere with the business operations on the DFF Property.

1.06 Parking Easements. There shall be parking easements and rights between the Aldi Property and the DFF Property, as such parking areas exist from time to time, provided, however, that except for certain reasonably areas marked off for curbside pickup or the like, neither party shall erect signs indicating parking is for only customers of such owner’s property.

1.07 Temporary Construction Easement. A non-exclusive temporary construction easement appurtenant to and for the benefit of the Aldi Property on, over, across a portion of the DFF Property (the “**Construction Easement**”). The area of the Construction Easement shall not unreasonably interfere with the DFF’s operation of its store on the DFF Property. All construction activities undertaken by Aldi shall be conducted so as to minimize interference with the business activities conducted on the Properties. The term of the Construction Easement shall terminate upon the issuance of a permanent occupancy certificate for the building to be constructed by Aldi on the Aldi Property (the “**Construction Easement Termination Date**”). Weather permitting, within thirty (30) days of the Construction Easement Termination Date, Aldi shall restore the Construction Easement area to the condition that existed prior to Aldi’s use thereof, including without limitation grading and seeding any disturbed topsoil or vegetation and restoring any excessively worn, cracked, or impacted paved areas damaged by Aldi. In the event Aldi fails to timely restore the Construction Easement area as required pursuant to the terms of this Section 1.07, DFF may undertake such restoration and provide an invoice for the actual and reasonable costs of such restoration to Aldi for reimbursement. Aldi shall reimburse DFF for such actual, reasonable, and documented costs within ten (10) business days of demand therefor, and any amounts not so reimbursed shall accrue interest at the rate of ten percent (10%) per annum. For the duration of construction on the Aldi Property, Aldi shall keep the portions of the Aldi Property and the DFF Property subject to the Construction Easement protected by

fencing (provided for clarity such fencing may be limited to the portions being actively used by workers, vehicles, and equipment) and in a good and slightly condition.

ARTICLE II
Restrictions

2.01. Use Restrictions on the DFF Property. DFF, for itself, its successors and assigns, hereby declares and imposes on the DFF Property, for the benefit of the Aldi Property, the restrictions on use set forth on **Exhibit D-1**, attached hereto and made a part hereof. Aldi, for itself, its successors and assigns, hereby declares and imposes on the Aldi Property, for the benefit of the DFF Property, the restrictions on use set forth on **Exhibit D-2**, attached hereto and made a part hereof.

ARTICLE III
Maintenance Obligations

3.01. Construction, Maintenance and Repair of the Properties. Subject to the provisions hereinafter set forth:

(a) DFF shall be responsible for the annual maintenance, repair and operation of the Critical Access Drives; provided, however, the costs of the same shall be shared by all owners of parcels of the Properties, pro-rata, based on the relative square footage of each such parcel. Notwithstanding the foregoing to the contrary, (i) Aldi shall be responsible for reimbursing DFF for DFF's costs and expenses incurred in connection with repairs (excluding normal wear and tear) to the Critical Access Drives caused by or resulting from Aldi's violation of this Agreement or any use of the DFF Property by any construction vehicles, construction machinery, or tractor trailers except to the extent expressly permitted pursuant to this Agreement; and (ii) DFF shall be responsible for reimbursing Aldi for Aldi's costs and expenses incurred in connection with repairs (excluding normal wear and tear) to the Critical Access Drives caused by or resulting from DFF's violation of this Agreement or any use of the Aldi Property by any construction vehicles, construction machinery, or tractor trailers except to the extent expressly permitted pursuant to this Agreement.

(b) Except as set forth in Section 3.01 (a), DFF shall, at its sole cost, maintain or cause to be maintained the DFF Property and all of the improvements thereon, at all times, in a good and safe condition and state of repair.

(c) Except as set forth in Section 3.01 (a), Aldi shall, at its sole cost, maintain or cause to be maintained the Aldi Property and shall construct and maintain all of the improvements thereon, at all times, in a good and safe condition and state of repair.

(d) While any portion of the Properties remains undeveloped, the owner thereof shall keep such portion in slightly condition.

ARTICLE IV
Insurance; Indemnification

_____ / _____

4.01. Insurance. Each Party shall, at its own expense, obtain, carry and keep in force commercial general liability insurance against any liability or claim for personal injury, wrongful death or property damage for which the Party is responsible to the other under this Agreement or by law, with financially responsible insurers authorized to transact insurance business in the State of Iowa, with a combined single limit of not less than \$1,000,000.00 per occurrence. Such insurance shall include all of the coverage typically provided by the Broad Form Comprehensive General Liability Endorsement. Such insurance may be written by additional premises endorsement on any master policy of insurance which may cover other property in addition to the Properties which form the subject of this Agreement; provided that the insurer shall provide a schedule to each Party showing that the coverage provided by such policy shall (a) meet the requirements of this Agreement; (b) not be reduced by any claims made with respect to other properties; and (c) be in such amount as will preclude the insureds from being held to be co-insurers. The policies shall name Aldi and DFF as additional insureds (as their interests may appear) and shall provide that they may not be canceled without 30 days' prior written notice to both insureds. Upon request, each Party shall provide to the other a certificate of insurance evidencing such coverage. Notwithstanding the foregoing provisions hereof to the contrary, Aldi shall have the right to self-insure so long as the tangible net worth of Aldi or the entity which owns a controlling interest of Aldi exceeds \$50,000,000, and the self-insuring party is consistently able to meet its financial obligations as they mature.

4.02. Indemnification.

(a) By DFF. Except for injuries, deaths, losses, damages, or other matters resulting from the acts or omissions of Aldi or of Aldi's agents, employees, servants, contractors and licensees, DFF shall indemnify Aldi and save it harmless from and against all loss, liability, damage, actions, causes of action, or claims for injury, death, loss or damage of whatever nature to any person, property or business interest caused by or resulting from an act or omission of DFF or of DFF's agents, employees, servants, contractors or licensees arising out of DFF's use and occupancy of the DFF Property, and from and against any and all costs, expenses or liabilities (including reasonable fees of attorneys, paralegals, experts, court reporters and others) incurred by Aldi in connection with any claim, action or proceeding in respect of any such loss, liability, damage or claim.

(b) By Aldi. Except for injuries, deaths, losses, damages, or other matters resulting from the acts or omissions of DFF or of DFF's agents, employees, servants, contractors and licensees, Aldi shall indemnify DFF and save it harmless from and against all loss, liability, damage, actions, causes of action, or claims for injury, death, loss or damage of whatever nature to any person, property or business interest caused by or resulting from an act or omission of Aldi or of Aldi's agents, employees, servants, contractors or licensees arising out of Aldi's use and occupancy of the Aldi Property, and from and against any and all costs, expenses or liabilities (including reasonable fees of attorneys, paralegals, experts, court reporters and others) incurred by DFF in connection with any claim, action or proceeding in respect of any such loss, liability, damage or claim.

4.03. Lien Removal. If, as a result of either Party's (the "**Contracting Party's**") exercise of any of the rights granted to it in this Agreement to enter onto and/or perform work upon the other Party's Property, a lien is filed by any contractor, subcontractor, laborer or materialman, then the Contracting Party shall discharge, bond or otherwise remove each such lien within 30 days following written notice from the other Party. If the Contracting Party fails to so discharge,

bond or otherwise remove any such lien within such period of time, the other Party may do so and the Contracting Party shall reimburse the other Party upon demand therefor for the reasonable cost thereof, including, without limitation, reasonable attorney fees incurred in discharging such lien, and Interest (as defined in Section 6.02(a) below).

ARTICLE V
Damage and Destruction

5.01. The Aldi Improvements. In the event the improvements on the Aldi Property (the "**Aldi Improvements**") are either destroyed or damaged by fire, flood, earthquake, or other casualty, Aldi shall have no obligation, under this Agreement, to repair, rebuild or restore the Aldi Improvements. However, if Aldi elects to repair, rebuild or restore the Aldi Improvements after any such damage or destruction, all construction activities undertaken in connection therewith shall be conducted so as to minimize interference with DFF use of its Property and the rights granted to it under this Agreement. If Aldi elects not to repair, rebuild or restore the Aldi Improvements after any such damage or destruction, Aldi shall raze the damaged improvements and either pave or seed and maintain such area and the easements granted to DFF pursuant to Article I hereof shall continue in full force and effect.

5.02. The DFF Improvements. In the event the improvements on the DFF Property (the "**DFF Improvements**") are either damaged or destroyed by fire, flood, earthquake, or other casualty, DFF shall have no obligation, under this Agreement, to repair, rebuild or restore the DFF Improvements. However, if DFF elects to repair, rebuild or restore the DFF Improvements after any such damage or destruction, all construction activities undertaken in connection therewith shall be conducted so as to minimize interference with Aldi's use of its Property and the rights granted to it under this Agreement. If DFF elects not to repair, rebuild or restore the DFF Improvements after any such damage or destruction, DFF shall raze the damaged improvements and either pave or seed and maintain such area and the easements granted to Aldi pursuant to Article I hereof shall continue in full force and effect.

ARTICLE VI
Defaults and Remedies

6.01. Defaults. If any Party (the "**defaulting Party**") should fail to observe any of the terms, conditions, restrictions or provisions of, or should fail to perform any of its covenants or obligations under this Agreement within a period of 30 days after the other Party (the "**non-defaulting Party**") has given to the defaulting Party written notice thereof, then the defaulting Party shall be in default under this Agreement; provided that if the obligation is of such a nature that the same cannot, with due diligence, be reasonably performed within such 30-day period, then such default shall be deemed to have been cured if the defaulting Party commences such performance within such 30-day period and thereafter undertakes and proceeds with due diligence to complete the same and does complete the same within a reasonable time. If a default has occurred and is not cured within the time period specified in this Section 6.01, then the non-defaulting Party shall have all of the rights and remedies afforded to it by law and also all of the rights and remedies set forth in Section 6.02 hereof (whether or not they are expressly provided by statute or recognized by judicial precedent), any one or more of which may be exercised and enforced independently or concurrently at any time that such default remains uncured, without waiving any of the non-defaulting Party's other rights and remedies, and all of which shall, to the extent applicable, survive the termination of any right granted in this Agreement.

6.02. Remedies.

(a) Cure. Following the expiration of the applicable cure period, the non-defaulting Party may, at its election, cure any default of the defaulting Party under this Agreement; and if the non-defaulting Party should do so, then it shall be entitled to be reimbursed for all reasonable and documented costs and expenses expended by it in connection therewith, together with interest ("**Interest**") thereon at the lower of (i) the rate of 10% per annum, or (ii) the maximum rate permissible from time to time under applicable law, from the date of the expenditure or the date when it shall have become due to the date of payment in full. Such costs, expenses and Interest shall be payable upon demand and presentation of such documentation. Any provision of this Agreement to the contrary notwithstanding, all sums due from a Party under the provisions of Article VI of this Agreement shall be in all respects subject and subordinate to the lien of any mortgages or deeds of trust at any time or from time to time encumbering the real property of the defaulting Party, and to the rights of the holder or holders of any indebtedness secured by the same.

(b) Civil Actions. Following the expiration of the applicable cure period, the non-defaulting Party may bring an action against the defaulting Party for the specific performance of any obligation undertaken by the defaulting Party in this Agreement, for injunctive or other equitable relief, or for damages in any court of competent jurisdiction for Black Hawk County, Iowa or such other jurisdiction as may be agreed to between the Parties, in order to enforce the rights and remedies available to the non-defaulting Party.

6.03. Obstruction Events. Notwithstanding anything to the contrary contained in this Agreement, in the event vehicular access to the Aldi Property is obstructed due to an obstruction on the DFF Property (including, but not limited to, the Critical Access Drives) or an activity of an DFF Permittee (each such event, a "**DFF Obstruction Default**"), Aldi may notify DFF by any means reasonable under the circumstances, including via email or telephone, of the DFF Obstruction Default and demand that the DFF Obstruction Default be remedied. If, after 2 hours after such notice has been provided, DFF has not remedied the DFF Obstruction Default or commenced to remedy the DFF Obstruction Default, Aldi shall have the right (but not the obligation) to remedy the DFF Obstruction Default (including the right to enter upon the DFF Property) and shall be reimbursed by DFF for the reasonable costs for such remedy in accordance with the provisions of Section 6.02(a) above. Further and notwithstanding anything to the contrary contained in this Agreement, in the event vehicular access to the DFF Property is completely obstructed due to an obstruction on the Aldi Property or an activity of an Aldi Permittee (each such event, an "**Aldi Obstruction Default**"), DFF may notify Aldi by any means reasonable under the circumstances, including via email or telephone, of the Aldi Obstruction Default and demand that the Aldi Obstruction Default be remedied. If, after 2 hours after such notice has been provided, Aldi has not remedied the Aldi Obstruction Default or commenced to remedy the Aldi Obstruction Default, DFF shall have the right (but not the obligation) to remedy the Aldi Obstruction Default (including the right to enter upon the Aldi Property) and shall be reimbursed by Aldi for the reasonable costs for such remedy in accordance with the provisions of Section 6.02(a) above.

ARTICLE VII

Notices; Notice of Transfer

7.01. Notices. Any notice or other communication required or permitted to be given to a Party under this Agreement shall be in writing and shall be deemed effective upon delivery (or refusal of delivery) when transmitted by one of the following methods to such Party at the address

set forth at the end of this Section 7.01: (a) via a nationally recognized overnight delivery service (such as FedEx or UPS); or (b) by certified mail, postage prepaid, return receipt requested. Either Party may change its address for notice by giving written notice thereof to the other Party at least ten (10) business days prior to the effective date of such change of address. The address of each Party for notice initially is as follows:

(a) If intended for DFF, to:

Davenport Farm & Fleet, Inc.,
3507 E. Racine Street
Janesville, WI 53546
Attn: Sara Iverson Smith

With a copy to:

Michael Best & Friedrich LLP
One South Pinckney Street, Suite 700
Madison, WI 53703
Attn: Porter J. Martin

(b) If intended for Aldi, to:

Aldi Inc., c/o Aldi Inc. (Minnesota)
Attn: Andrew Mack, Director of Real Estate
4201 Bagley Ave. N.
Faribault, Minnesota 55021

With a copy to:
Kooperman Mentel Ferguson Yaross
Attn.: Ryan Crossley, Esq.
100 S. Fourth Street, Suite 100
Columbus, Ohio 43215

7.02. Notice of Conveyance. If a Party (a "**Conveying Party**") should convey its fee interest in and to its Property (or any portion thereof) to another Person, it shall promptly notify the other Party of such conveyance in the manner provided in Section 7.01 hereof. Such notice shall contain the name of the grantee and the address of such grantee for purposes of receiving notices hereunder. Unless and until a Conveying Party notifies the other of a conveyance of its fee interest in and to its Property as provided for herein, notices addressed to the Conveying Party as provided for in Section 7.01 shall continue to be effective, but the other Party may also send notices that shall be deemed effective hereunder to such grantee at the tax mailing address listed for such grantee on the books of the County Assessor of Property, until such time as the grantee has notified the other Party of a different notice address in the manner provided in Section 7.01 hereof.

ARTICLE VIII Miscellaneous Provisions

8.01. Successors and Assigns. This Agreement shall inure to the benefit of and be binding upon the respective successors and assigns (including successive, as well as immediate,

successors and assigns) of the Parties.

8.02. Governing Law. This Agreement shall be governed by and construed in accordance with the laws of the state in which the Properties are situated. For all litigation, disputes and controversies which may arise out of or in connection with this Agreement, the undersigned hereby waive the right to trial by jury and consent to the jurisdiction of the courts in the state in which the Properties are situated. In the event either party hereto brings or commences legal proceedings to enforce any of the terms of this Agreement, the successful party shall then be entitled to receive from the other party(s), in every such action commenced, a reasonable sum as attorneys' fees and costs, including all fees and costs incurred upon any appeals, to be fixed by the court in the same action.

8.03. Restoration. If, as a result of the exercise of any easement rights created under this Agreement, a Party shall damage or disturb the improvements of another Party, the Party causing such damage or disturbance shall, at its sole expense, promptly repair or restore the real property of such other Party to, as nearly as possible, the condition existing prior to such damage or disturbance.

8.04. Duplicate Originals. This Agreement may be executed in one or more counterparts, each of which shall be deemed to be a duplicate original, but all of which, taken together, shall constitute a single instrument. Signature pages may be detached from multiple separate counterparts and attached to a single counterpart so that all signature pages are physically attached to the same document.

8.05. Article and Section Captions. The Article and Section captions contained in this Agreement are included only for convenience of reference and do not define, limit, explain or modify this Agreement or its interpretation, construction or meaning and are in no way to be construed as a part of this Agreement.

8.06. Severability. If any provision of this Agreement or the application of any provision to any Person or any circumstance shall be determined to be invalid or unenforceable, then such determination shall not affect any other provision of this Agreement or the application of said provision to any other Person or circumstance, all of which other provision shall remain in full force and effect.

8.07. Amendments in Writing. No change, amendment, termination or attempted waiver of any of the provisions of this Agreement shall be binding upon any Party unless in writing and signed by the Parties.

8.08. Agreement for Exclusive Benefit of Parties. The provisions of this Agreement are for the exclusive benefit of the Properties, the Parties (and their successors and assigns) and the Permittees of the Parties and not for the benefit of any other Persons, and this Agreement shall not be deemed to have conferred any rights, express or implied, upon any other Persons.

8.09. No Partnership, Joint Venture or Principal-Agency Relationship. Neither anything contained in this Agreement nor any acts of the Parties shall be deemed or construed by the Parties, or either of them, or by any third Person, to create the relationship of principal and agent, or of partnership, or of joint venture, or of any association between the Parties to this Agreement.

8.10. Reasonableness of Consent or Approval. Whenever a Party is entitled to exercise some right under this Agreement, only with the prior consent or approval of another Party, such consent or approval shall not be unreasonably withheld or delayed.

8.11. Covenants Run With the Land. It is intended that the covenants, easements, agreements, promises and duties of each Party, as set forth in this Agreement, shall be construed as covenants and not as conditions and that all such covenants shall (subject to the provisions of Section 8.14 hereof) be enforceable against the covenantor and shall also run with the land or constitute equitable servitudes as between the real property of the respective covenantor, as the servient tenement, and the real property of the respective covenantee, as the dominant tenement. If a Property is subdivided and sold, any obligation or expense attributed to a subdivided parcel shall be deemed an expense of such subdivided parcel and the then owner thereof. Any owner of a Property which is the subject hereof may grant the benefit of, or allow the use of, any right, easement or interest hereunder to any Permittee of any owner from time to time; provided that any such Permittee shall have no greater rights than its permittor and shall look solely to its permittor (or to such permittor's successors or assigns), in each case, for the enforcement of the provision of this Agreement.

8.12. No Merger. All of the provisions of this Agreement are for the mutual benefit and protection of the present and all future owners of the Properties; and if there should at any time be common ownership of any of the Properties, or any estate therein then it is the intention of the Parties that there be no merger into the respective fee simple estates of the rights and benefits and the obligations and burdens of this Agreement, but rather that such rights and benefits and such obligations and burdens shall be separately preserved for the benefit of all future owners of the fee simple estates in the Properties.

8.13. No Dedication. Nothing in this Agreement shall be deemed to constitute a gift, grant or dedication of any portion of the Aldi Property or the DFF Property to the general public or for any public purpose; provided that the Parties shall have the right to extend the benefit of any of the easements granted herein to any governmental unit, public body and/or utility company for the purpose of the construction, installation, operation, maintenance, repair, relocation, modification, extension or alteration of Utility Lines and related facilities, but such grant shall be subject to the terms and conditions hereof.

8.14. Termination of Liability Upon Transfer. If the owner of a Property should transfer its fee simple interest (or any portion thereof) in and ownership of such Property, then the obligation and liability of the transferor for the performance or breach of any covenant or provision contained in this Agreement, occurring after the date of such transfer, shall automatically be terminated; and the transferee, by the acceptance of the conveyance of such fee simple interest, shall automatically be deemed to have accepted, assumed and agreed to observe or perform all such covenants or provisions after the date of such transfer.

8.15. Definition of Certain Terms. As used in this Agreement, the term "**Person**" means a corporation, association, partnership, limited liability company, trust, estate, governmental agency or other entity, as well as an individual or natural person, unless the context otherwise requires, the term "**Permittee**" means the respective employees, agents, customers, contractors, licensees, guests and invitees of Aldi and DFF, and the term "**Party**" means Aldi or DFF individually (or "**Parties**" shall mean Aldi and DFF collectively) and their respective successors and assigns. The term "business day" when used herein shall mean a weekday, Monday through

Friday, except a legal holiday or a day on which banking institutions in the State of Iowa are authorized by law to be closed.

8.16. Index of Exhibits. The following exhibits attached to this Agreement are hereby incorporated herein:

- Exhibit A – Site Plan
- Exhibit B – Aldi Property Legal Description
- Exhibit C – DFF Property Legal Description
- Exhibit D-1 – Use Restrictions on the DFF Property
- Exhibit D-2 – Use Restrictions on the Aldi Property

IN WITNESS WHEREOF, the Parties have caused this Agreement to be executed by their duly authorized representatives, to be effective as of the date first above written.

[REMAINDER OF THIS PAGE INTENTIONALLY LEFT BLANK]
Signature and Acknowledgment Pages Follow

EASEMENT AND RESTRICTION AGREEMENT
(DFF Signature and Acknowledgment)

DFF:

Davenport Farm & Fleet, Inc.,
an Iowa corporation

By: _____
Jane Blain Gilbertson,
President / CEO

STATE OF _____)
)
COUNTY OF _____)

ACKNOWLEDGMENT

The foregoing instrument was acknowledged before me this _____ day of _____, 2021, by Jane Blain Gilbertson, President / CEO of **Davenport Farm & Fleet, Inc.**, an Iowa corporation, on behalf of said corporation.

Notary Public for _____

My Commission expires: _____

EASEMENT AND RESTRICTION AGREEMENT
(Aldi Signature and Acknowledgment Page)

Aldi Inc.,
an Illinois corporation

By: _____
Matt Lilla, Divisional Vice President

STATE OF MINNESOTA)
)
COUNTY OF RICE)

ACKNOWLEDGMENT

The foregoing instrument was acknowledged before me this _____ day of _____, 2021, by Matt Lilla, Divisional Vice President of **Aldi Inc.**, an Illinois corporation, on behalf of said corporation.

Notary Public for _____

My Commission expires: _____

EXHIBIT A
Site Plan
Page 1 of 3

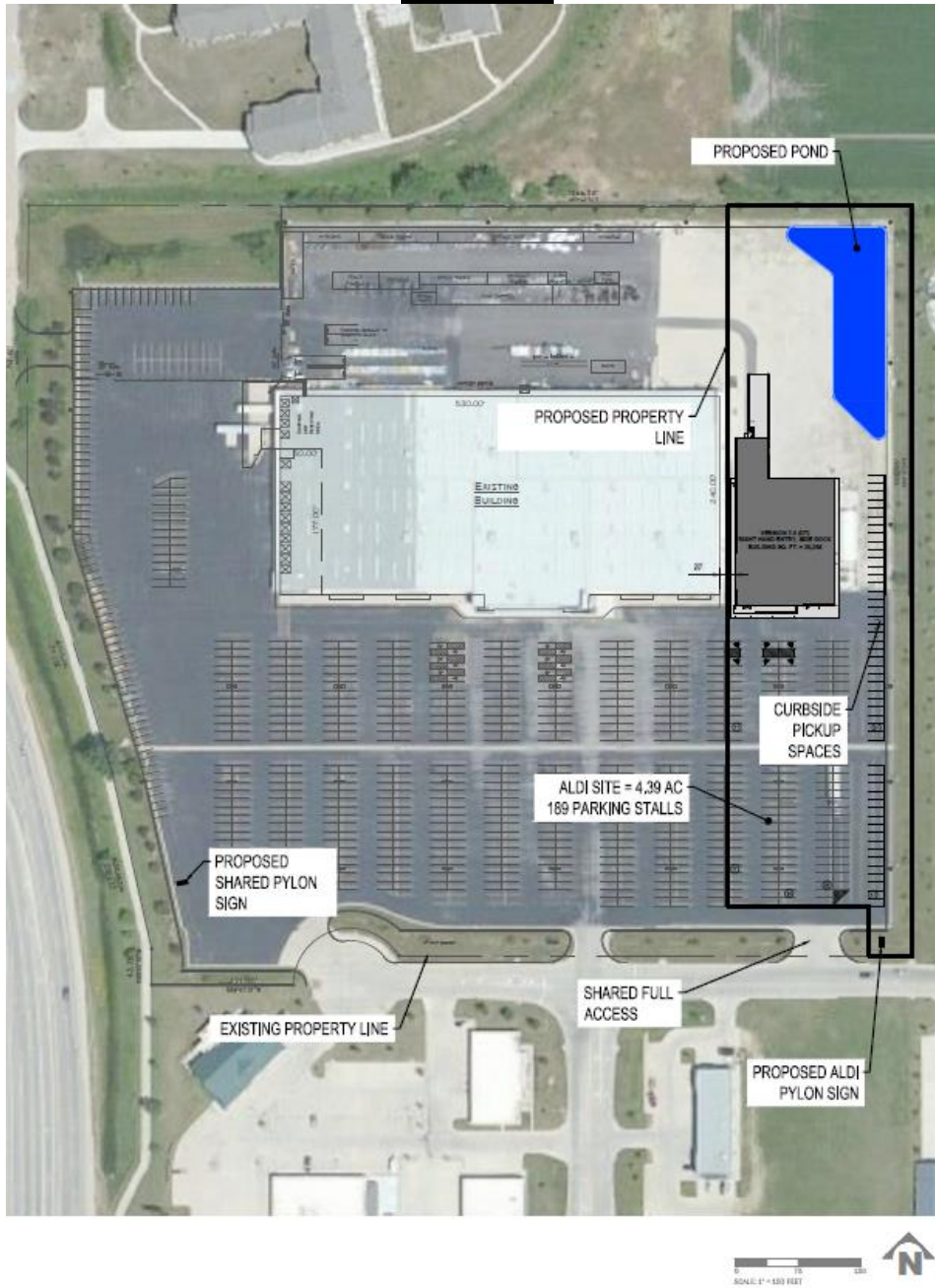

EXHIBIT A
Site Plan
Page 2 of 3

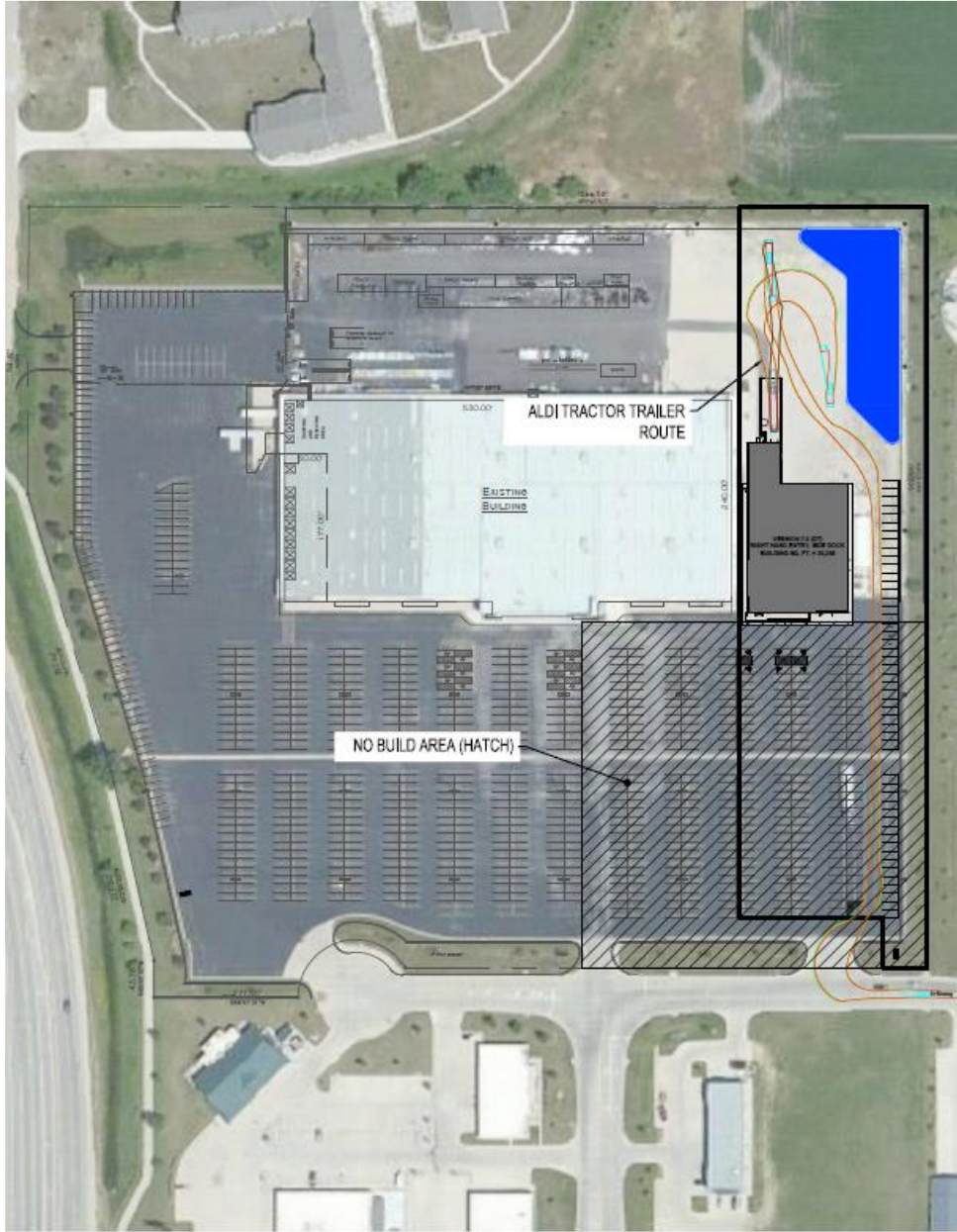

EXHIBIT A
Site Plan
Page 3 of 3

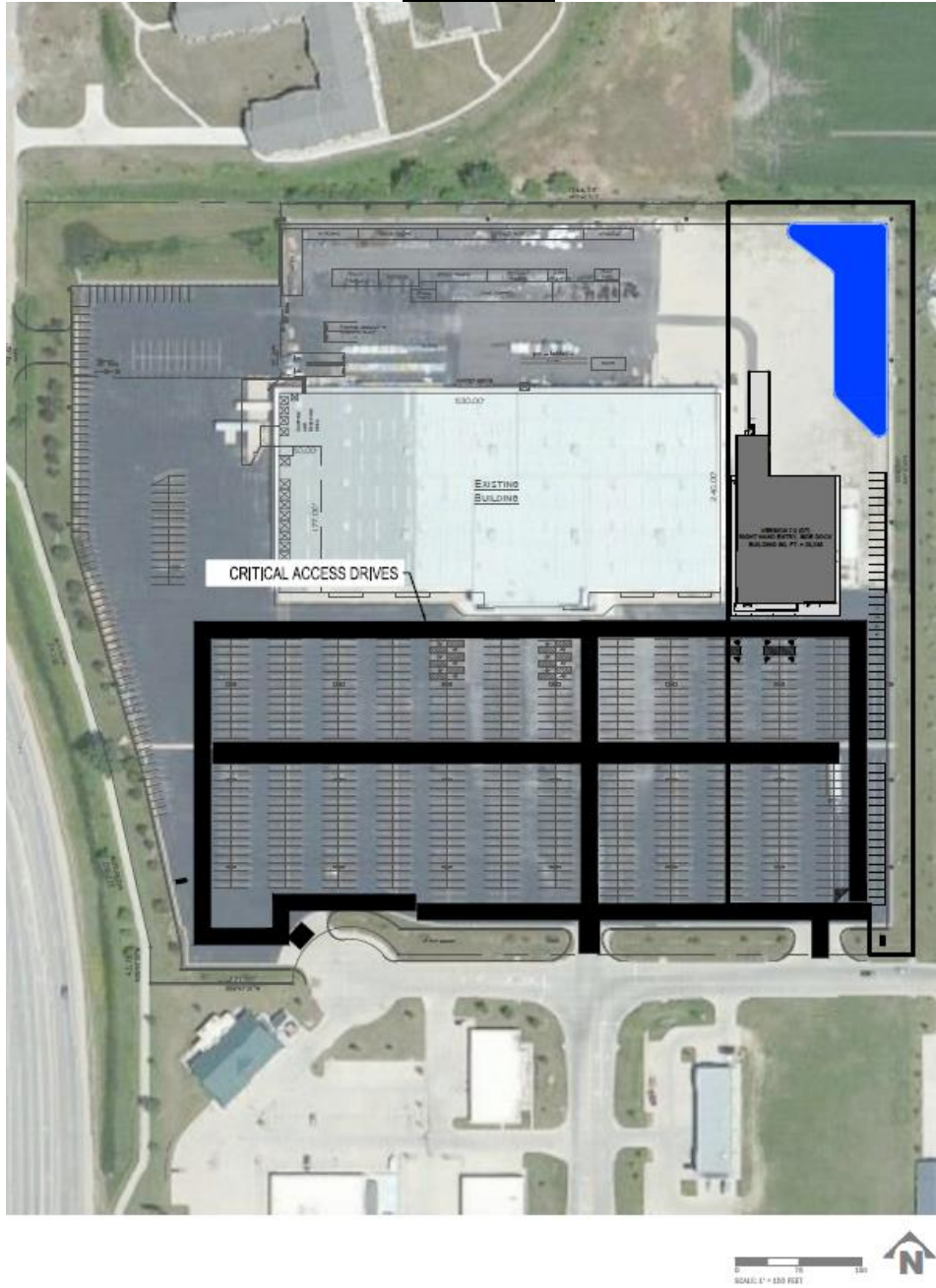

EXHIBIT B
Aldi Property Legal Description

EXHIBIT C
DFF Property Legal Description

Exhibit D-1
Use Restrictions on the DFF Property

No portion of the DFF Property may be used for any of the following purposes:

(a) a Retail Grocery Store. The term "Retail Grocery Store" means a supermarket, a meat market, a grocery store, a fruit and vegetable store or stand, a frozen or otherwise processed food store, and any other store where more than 2,500 square feet (including adjacent aisle space) is used for the sale of grocery items. "Retail Grocery Store" shall also include the operation of a grocery pick-up service (e.g. Clicklist, Curbside Pickup or similar service) anywhere on the DFF Property, whether or not the premises from which the service is offered is also used for the sale and display of grocery items. "Retail Grocery Store" does not include a delicatessen or any restaurant wherein prepared food is sold for on-premises or "take-out" consumption; This restriction will not apply to the operation of Blain's Farm & Fleet store on DFF Property and will expire if Aldi ceases to operate permanently for a consecutive period of 365 days, excluding periods of initial construction, renovation, remodeling, casualty, condemnation and Force Majeure.

(b) Any operation primarily used as a storage warehouse operation, and any assembling, manufacturing, distilling, refining, smelting, agricultural, or mining operation;

(c) Any "second hand" store or pawnshop, including Goodwill, Salvation Army, and the likes, other than national or regional retailers such as Savers, Play it Again Sports, and the like;

(d) Any fire sale, bankruptcy sale (unless pursuant to a court order) or auction house operation;

(e) A billiard or bingo parlor;

(f) A flea market;

(g) A funeral home;

(h) A facility for the sale of paraphernalia for use with illicit drugs or a marijuana dispensary;

(i) A facility for the sale or display of pornographic material (as determined by community standards for the area in which the DFF Property is located);

(j) An off-track betting parlor;

(k) A carnival, amusement park or circus;

(l) A facility for any use which is illegal or dangerous;

(m) An abortion or reproductive health clinic or blood bank;

(n) A dry-cleaning plant, central laundry or laundromat;

(o) A skating rink;

(p) A training or educational facility (including, without limitation, a beauty school, barber college, reading room, school or other facility catering primarily to students or trainees rather than customers); provided, however, this prohibition shall not be applicable to on-site employee training by an owner or occupant incidental to the conduct of its business at the DFF Property; or

(q) A school, church, or other place of worship;

(r) An adult video store and adult bookstore;

(s) An adult entertainment club or night club;

(t) A tattoo parlor or body piercing establishment;

(u) A hotel, motel or other place of residence;

(v) A junk yard; or

(w) An animal facility, provided the foregoing shall not restrict DFF from selling chicks seasonally and ancillary to its operation of a Blain's Farm & Fleet store.

EXHIBIT D-2
Use Restrictions on the Aldi Property

No portion of the Aldi Property may be used for any of the following purposes:

(a) a “farm & home” type retailer; Examples of “farm and home” retailers include Mill’s Fleet Farm, Big R, Family Farm & Home, Rural King, & Theisen’s, Tractor Supply, muffler store, tire store, oil change facility, auto parts store, hardware store, paint store, lawn and garden store, apparel store, pet supply stores, and footwear store will also be restricted.

(b) Any operation primarily used as a storage warehouse operation, and any assembling, manufacturing, distilling, refining, smelting, agricultural, or mining operation;

(c) Any “second hand” store or pawnshop, including Goodwill, Salvation Army, and the likes, other than national or regional retailers such as Savers, Play it Again Sports, and the like;

(d) Any fire sale, bankruptcy sale (unless pursuant to a court order) or auction house operation;

(e) A billiard or bingo parlor;

(f) A flea market;

(g) A funeral home;

(h) A facility for the sale of paraphernalia for use with illicit drugs or a marijuana dispensary;

(i) A facility for the sale or display of pornographic material (as determined by community standards for the area in which the Aldi Property is located);

(j) An off-track betting parlor;

(k) A carnival, amusement park or circus;

(l) A facility for any use which is illegal or dangerous;

(m) An abortion or reproductive health clinic or blood bank;

(n) A dry-cleaning plant, central laundry or laundromat;

(o) A skating rink;

(p) A training or educational facility (including, without limitation, a beauty school, barber college, reading room, school or other facility catering primarily to students or trainees rather than customers); provided, however, this prohibition shall not be applicable to on-site employee training by an owner or occupant incidental to the conduct of its business at the Aldi Property; or

- (q) A school, church, or other place of worship;
- (r) An adult video store and adult bookstore;
- (s) An adult entertainment club or night club;
- (t) A tattoo parlor or body piercing establishment;
- (u) A hotel, motel or other place of residence;
- (v) A junk yard; or
- (w) An animal facility.

DEPARTMENT OF COMMUNITY DEVELOPMENT



City of Cedar Falls
220 Clay Street
Cedar Falls, Iowa 50613
Phone: 319-273-8600
Fax: 319-273-8610
www.cedarfalls.com

MEMORANDUM Planning & Community Services Division

TO: Planning & Zoning Commission
FROM: Jaydevsinh Atodaria (JD), City Planner I
Ben Claypool, PhD, EI, Civil Engineer II
DATE: April 22, 2021
SUBJECT: Aldi's Grocery Store Site Plan

REQUEST: Site plan approval for construction of a new Aldi's.(Case # SP21-005)

PETITIONER: Davenport Farm and Fleet INC, Owner ; Andrea Rand (ISG), Engineer

LOCATION: 315 Brandilynn Boulevard

PROPOSAL

The applicant proposes to construct up to two-story, 20,288 square foot grocery store, a locally recognized Aldi's store, on 315 Brandilynn Boulevard. The proposal is following the approval of the proposed Blain's Corner 2nd addition Minor plat. The proposal includes some site improvements, new signage, landscaping improvements, parking lot alterations, and a new building accommodating Aldi's Grocery store. The proposed layout of the building sits on about 4.41

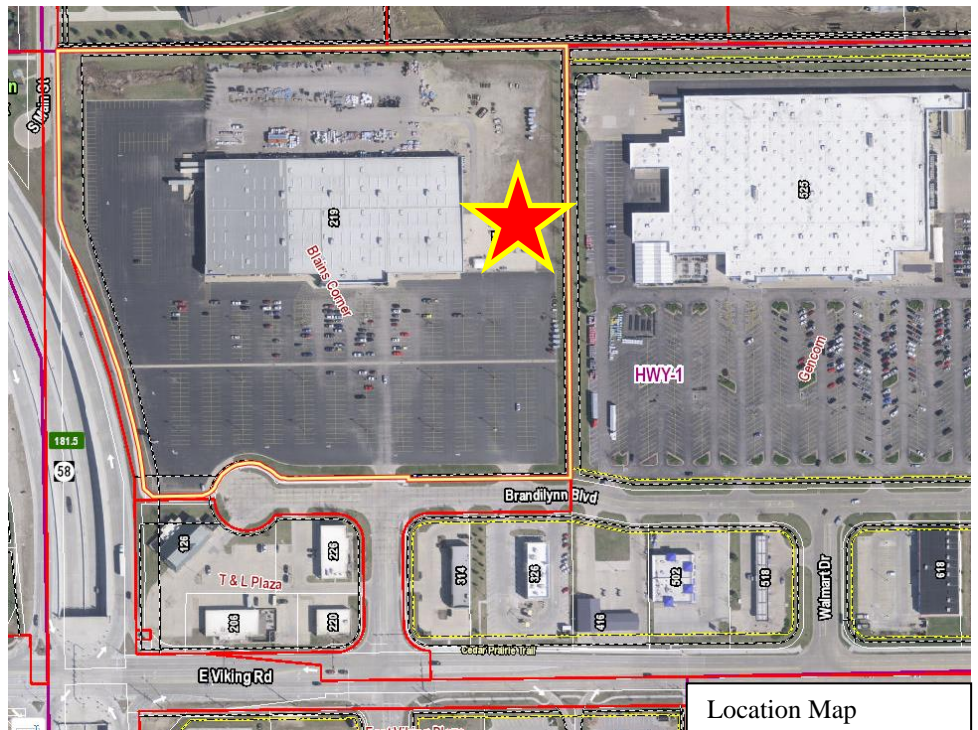

Location Map

acres of land located on Brandilynn Blvd. and will be placed just east of the existing Blain's Farm and Fleet store. This project will include the removal of the excess storage area to the east of the existing Blain's building, where the proposed Aldi's store would sit.

BACKGROUND

The parcel was created by Blain's Corner Addition to Cedar Falls, Iowa in 1998. The property is in the HWY-1, Highway Commercial Zoning District.

This proposal is to develop Aldi's grocery store on parcel "W" which will be created after the approval of the proposed Blain's Corner 2nd addition Minor plat which aims to convert the existing Blain's lot into two commercial developable lots. The two commercial developable lots will then include a chunk of 16.47 acres utilized by the existing Blain's Farm and Fleet store and the rest 4.41 acres utilized by the proposed Aldi's grocery store.

ANALYSIS

The proposed site plan development is in the HWY-1 Highway Commercial Zoning District. The HWY-1 District is intended to promote and facilitate comprehensively planned commercial developments located adjacent to major transportation corridors and interchanges. The purpose of these regulations is to encourage high standards of building architecture, and site planning which will foster commercial development that maximizes pedestrian convenience, comfort and pleasure. The ordinance requires a detailed site plan review before approval to ensure that the development site satisfies several basic aesthetic standards. Attention to details such as parking, open green space, landscaping, signage, building design, and other similar factors help to ensure orderly development in the entire area.

Following is a review of the zoning ordinance requirements for the proposed development:

- 1) Use: A grocery store serving traveling public or a regional customer base is a permitted use in the HWY-1 District. **Use is allowed.**
- 2) Building Location: The proposed new Aldi grocery store will be located on "Parcel W", after the approval of submitted Blain's Corner 2nd Addition Minor Plat. The proposed new building will be placed in line with the existing Blain's Farm and Fleet store to the west. As per code, a 20-foot setback consisting of landscape material shall be established around the perimeter of the district. This 20-foot setback should be free of any structure or parking areas. The proposed site plan follows the required 20 feet setback along the south, east, and north property line by the provision of required landscaping. In addition, a 10-foot building setback is proposed along the west property line to break the visual barrier between Blain's and Aldi's building. The proposed building footprint is approximately 20,300 square feet, which is significantly less compared to the adjacent buildings to east

and west. The site plan shows that the building might be expanded northward in the future by extending the north wall.

The building will have two main public ingress/egress areas along the south wall of the building and will have a door each on the west, east, and north façade to access site areas for staff.

The site plan shows one access point to the proposed building and parking lot which will be part of the shared access easement from Blain’s site. The access point will be from Brandilynn Boulevard. **Building setbacks are satisfied.**

- 3) Parking: The parking requirement for the new building is 92 parking stalls (4.5 stalls per 1000 square feet of gross floor area). The provided site plan shows 172 parking stalls, which includes 6 ADA stalls. Parking is provided in the south and east areas of the lot. The site plan shows minor adjustments to accommodate additional green space, landscaped islands, and other landscaped buffer areas. The parking meets the zoning standards with 9’ x 19’ stalls and 22’ wide aisles. **The amount and dimension of the parking stalls and drives are met.**
- 4) Open Space Requirements: This property is located within the HWY-1 Highway Commercial Zoning District. This zoning district requires that open space/landscaping requirements be provided at the rate of 10% of the total development site area excluding the perimeter setback area. Following is a summary of the landscape plan that details how this provision is met.

New Development Site	192,252 SF	
Required Open/Green Space	19,225 SF	10%
Provided Open/Green Space	64,144 SF	34%

Landscaping is shown throughout the site, both around the building as well as within the parking lot, and along the streets within required setbacks.

The open green space exceeds the minimum requirement and is well distributed.

- 5) Landscaping: The HWY-1 Highway Commercial Zoning District requires minimum landscaping at the rate of 0.02 points per sq. ft. of total development site area as far as zoning district requirement is concerned. This can be achieved with the planting a combination of trees and shrubbery. A minimum of 0.75 points per linear foot of street frontage shall be planted with Street tree plantings. Besides, tree plantings and other landscape treatments shall be required within designated parking areas to provide shade and visual relief in large parking areas.

Parking Lot Improvisation Requirement: Peripheral landscaping and internal landscaping are also required if existing off-street parking lots are altered or enlarged, in whole or in part. Peripheral landscaping requirements include

placement of continuous landscaped strip not less than 5 feet in width and at least three feet in height, and one tree for every 50 lineal feet of landscaping barrier to screen the parking areas from the public streets and abutting lots. And Internal landscaping requirement includes placement of one overstory tree for every 21 parking stalls to shade the internal parking areas.

Overall, the total required landscaping points is 3,940 points which include 3,775 Site area points and 165 street frontage points. In response, the applicant proposes landscaping points summing to 4,020 Points (3,780 site points & 240 street frontage points). Planting point details can be seen in the attached landscaping plan for review.

Also, about 12 parking lot trees are required as per calculation, in response applicant proposes 12 parking lot trees including 2 existing site trees.

Overall, landscaping on the site is well distributed on all three sides of the building including parking lot screening with shrubs and trees along the east lot line, landscaping islands with trees and ground cover. **Landscaping requirements are met.**

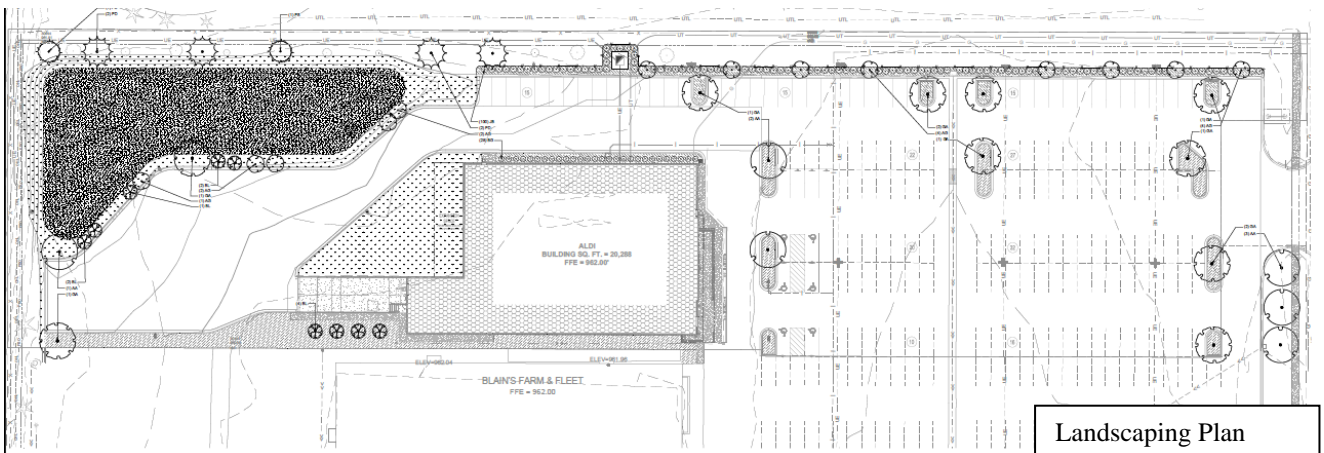

Landscaping Plan

- 6) **Design Review:** As per HWY-1 Highway Commercial Zoning district, all structures established within the district shall be reviewed for architectural compatibility with surrounding structures. The review must also focus on building materials, exterior materials on all sides, coloration, roof-line, size, and location of windows and doors, facades, and signage. The elements in the code are noted below with a review of how each is addressed. **Overall, staff finds that the proposed building design meets the zoning standards based on the following analysis.**

Proportion: The relationship between the width and height of the front elevations of adjacent buildings shall be considered in the construction or alteration of a building; the relationship of width to height of windows and doors of adjacent buildings shall be considered in the construction or alteration of a building.



The scale and proportion of the new building will be slightly smaller than the adjacent building to the west and east, which includes Wal-Mart and Blain's Farm and Fleet Store. And the proposal will be slightly bigger than the commercial building to the south, which houses a couple of retail stores. Both the buildings to the west and east are about two stories in height, the proposed building will also look somewhat similar with only the south façade extending at an angle to emphasize the look of the building. The maximum height of the proposed building is about 29 feet, which just extends on the southwest section of the building. Rest

all the building facades are no taller than 19 feet in height. The width of the face is comparatively smaller to the Wal-Mart store to the east and Blain's store to the west, as the building area is a lot smaller than the big box stores in the surrounding. **Staff finds that the proposal is consistent with neighboring buildings and with the height allowances in the zoning district.**

Roof shape, pitch, and direction: The similarity or compatibility of the shape, pitch, and direction of roofs in the immediate area shall be considered in the construction or alteration of a building.

The adjacent buildings utilize flat roofs with a parapet around the edge and enhanced entrance features like adding more massing and heights than the entire building. The new building will likewise utilize a flat roof with metal coping around the edge and will highlight the entrance area of the building by extending the south face of the building from 19 feet to 29 feet that will span the one-way inclined roof over the entrance. The roofing style of the proposed building matches the existing roofing styles of the neighboring building. An enhanced entrance area with the inclined roof will be enhancing the store façade.

Pattern: Alternating solids and openings (wall to windows and doors) in the front facade and sides and rear of a building create a rhythm observable to viewers. This pattern of solids and openings shall be considered in the construction or alteration of a building.

The new building will feature an aluminum curtain wall system and glass on the south façade of the building as few openings. The rest of the facades will be mostly blank with few door openings to access outdoor site areas. Because of the nature of the use of the store, most of the facades are blank except for the south façade, which is the entrance to the building. Overall, the building materials and patterns meet the city's standards.

Materials and texture: Materials and texture. The similarity or compatibility of existing materials and textures on the exterior walls and roofs of buildings in the immediate area shall be considered in the construction or alteration of a building. A building or alteration shall be considered compatible if the materials and texture used are appropriate in the context of other buildings in the immediate area.

Glass, Curtain Wall, Glass, brick masonry, aluminum composite panels, and fiber cement exterior cladding are the exterior materials proposed for the new building. Most of the materials will provide a slightly rough texture as the majority of the building facades are finished with brick masonry. Several smooth finishes will be observed along the south building façade as there are different materials and textures used to enhance the entrance of the building. In total, approximately 70% of the building will be made up of brick masonry, 15% mixture of aluminum composite panels and fiber cement cladding, and 15% glass.

The adjacent buildings are constructed almost entirely of concrete masonry or fiber cement sidings. Staff finds the proposed building materials will enhance the building and will create a distinctive look.

Color: The similarity or compatibility of existing colors of exterior walls and roofs of buildings in the area shall be considered in the construction or alteration of a building.

The new building will primarily include dark chocolate/grey tone as part of brick masonry while the contrasting tones of silver colors will be seen along the south façade of the building. To enhance the entrance a wooden color fiber cement cladding will be seen along the entrance area.

Architectural features: Architectural features, including but not limited to, cornices, entablatures, doors, windows, shutters, and fanlights, prevailing in the immediate area, shall be considered in the construction or alteration of a building. It is not intended that the details of existing buildings be duplicated precisely, but those features should be regarded as suggestive of the extent, nature, and scale of details that would be appropriate on new buildings or alterations.

The architectural style is similar to traditional big-box store design in nature. Architectural features of the new building include an inclined roof over the heightened entrance area of the building located along the south wall. The building will mostly utilize a flat roof except for the entrance area. Rooflines are similar to the surrounding building except for the increased heightened area on the south-west corner of the building, which provides a unique identity to the building. The color choice also stands out while the materials are generally consistent with the neighbors.

7) Trash Dumpster Site: The dumpster enclosure is located behind the building, along the North wall of Aldi’s building. Trash dumpster is about 6.5 feet in height (as shown to the right) and will be placed in loading dock area, with the lower half completely covered and upper half will be covered partially with 3.5 feet high galvanized steel guard rail details.

Staff finds no major concern with the placement of the dumpster.

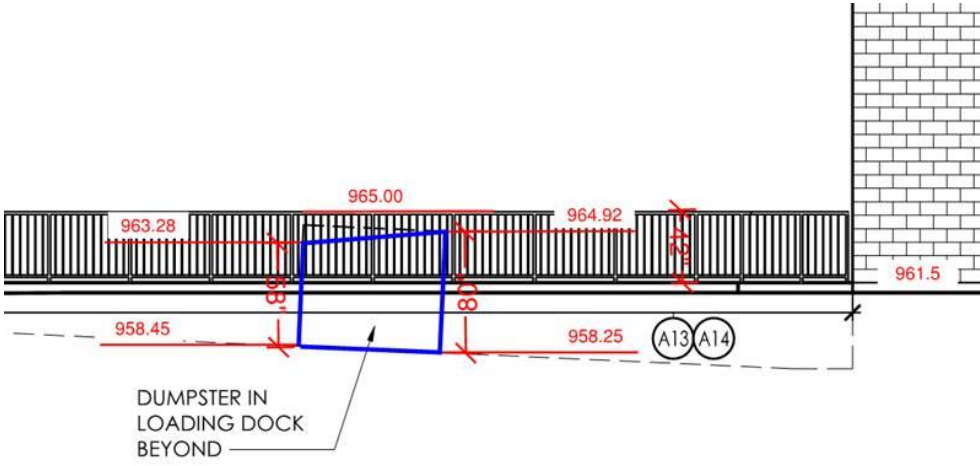

- 8) Lighting: The HWY-1 District regulations do not have specific lighting design guidelines. The applicant has proposed both wall mount lights to highlight the building on all three sides and pole lights with a single head, triple head, and quad head that highlight the parking lot on the site. All the lights are downcast and their illumination will not be bothering neighboring properties. A detailed site lighting plan and light fixture schedule have been attached to the packet for review. **Lighting is acceptable.**
- 9) Signage: For the proposed new building, two wall signs are illustrated on the building; one facing south and another facing east. As per code, wall sign areas cannot exceed 20 percent of the surface area of the single wall to which it is affixed. No more than two wall surfaces of any single structure may be utilized for sign displays. Both wall sign areas meet the code requirement.

Besides, the applicant is proposing a free-standing sign to highlight the new Aldi's grocery store in the south-eastern part of the lot. As per code, the maximum allowable square footage for all free-standing signs combined is 250 square feet and the allowable sign height is 40 feet. The proposed freestanding sign is 40 feet in height and 120 square feet in area, meeting the code requirements. This signage will be placed 10 feet northward from the south property line as required by the code. No single-use is permitted more than one 40-foot tall. Also, the applicant is also proposing to remove the existing Blain's free-standing sign advertising "Blain's Farm and Fleet" along Highway 58 and want to replace it with a new free-standing sign that advertises both "Aldi's" and "Blain's Farm and Fleet" meeting all the code requirements. An off-premise sign is usually not allowed in HWY-1 zone but because Blain's site is in HCG Highway Corridor and Greenbelt Overlay Zoning district and staff finds this a reasonable request as this sign would allow attracting traffic from the Highway and Intersection. Staff notes that no new free-standing sign will be allowed on Blain's site as they have used the maximum sign area allowance on site. Both freestanding signs proposed meet the code requirement, sign details have been attached with the packet for additional review. **Proposed Signage is acceptable.**

- 10) Sidewalks: There is a 5-foot-wide PCC sidewalk proposed in the site plan which will extend the portion of Cedar Prairie Trail to the eastern lot line from its existing location. This will allow pedestrian traffic to access the building. This sidewalk will be placed 5 feet north to the south property line and will be over the existing 10 feet utility easement. To accommodate the sidewalk, a 5 feet wide public pedestrian access easement has been noted on both the minor plat and the site plan. The sidewalk proposed provides good pedestrian circulation and meets City standards.
- 11) Storm Water Management: The stormwater management for this site will be taking the northeast corner of redevelopment and applying the current post-construction stormwater controls before this stormwater entering the existing stormwater facilities for the Blain's Farm and Fleet site. With storm sewer piping and a detention basin in the very NE corner, the full capture of the 100-year rainfall event will be released at a rate less than the existing 2-year storm, while also controlling water quality through

a control structure with two operating weirs. In the event of a storm exceeding the 100-year event, there is an additional 1.05 feet of freeboard within the detention basin and outlet structure that will allow the temporary on-site capacity. **The stormwater management plan meets City requirements and will be approved by the engineering division with the Maintenance and Repair Agreement.**

TECHNICAL COMMENTS

Cedar Falls Utilities (CFU) has reviewed the Hwy 1 Site Plan for the proposed Aldi's. Water, electric, gas, and communications utility services are available in accordance with the service policies of CFU. Water is available from a privately owned 12" water main in front of the proposed Aldi's that serves two fire hydrants, one on the east side and one on the south side of Blain's. The Aldi's preliminary construction plans incorrectly show this 12" water main as a 6" main. The construction plans show relocating the east fire hydrant. Existing valving will require the interruption of the fire protection during this hydrant relocation work. Gas services are owned, installed, and maintained by CFU. If the primary heat source for the new building is natural gas, CFU will install the gas service at no cost to the owner. Plans show the proposed electric transformer location east of the proposed building. The building electrical contractor will install the conduits and electric service from the building to the transformer. High speed fiber service for internet, cable TV, and phone is available to the building site. CFU suggests the electric construction contractor install an additional conduit from the building to the electric transformer site for future fiber installation. Please have the general contractor contact CFU for coordination of utility service locations.

All technical errors have been addressed in the revised drawing submitted for review. City staff has attached revisions for review in the packet.

A courtesy notice to surrounding property owners was mailed on April 7, 2021.

STAFF RECOMMENDATION

The Community Development Department has reviewed the proposed site plan for Aldi' grocery store and recommends approval, subject to the following conditions:

1. The developer must address all comments and directions specified by the Planning and Zoning Commission.
2. The developer's plan must conform to all city staff recommendations and technical requirements.

Staff notes that the case if approved tonight by the Planning and Zoning Commission, the case will be presented to the City Council, once staff receives all the legal paper work with required signatures and stamps for the Blain's Corner 2nd Addition Minor Plat, as the site plan cannot be approved prior approval of the Minor Plat.

PLANNING & ZONING COMMISSION

Discussion 4/14/2021	Chair Leeper introduced the item and Mr. Atodaria provided background information. He explained that the proposal is to develop a 20,299 square foot
-------------------------	------------------------------------------------------------------------------------------------------------------------------------------------------

Aldi grocery store which will be created after the approval of the proposed Blain's Corner 2nd addition minor plat. He discussed the basic information regarding the site plan, including setbacks, access points, lot lines and the trash location. He explained the requirements with regard to parking and open/green space, as well as the proposed sidewalk and landscaping plans. Mr. Atodaria provided renderings of the proposed signage and where it would be located if approved, as well as the design review, which includes proportion, roof shape/pitch/direction, pattern, materials, color and architectural features. He discussed the technical comments that still need to be addressed by the applicant and noted that they believe they will be completed by the next Commission meeting. At this time the item is just for discussion and public comment.

Mr. Schrad asked if the proposed detention area meets the requirements for the square footage of the parking lot. Mr. Atodaria explained that it has been met.

Mr. Larson asked what the technical issues are that still need to be resolved. Mr. Atodaria explained that they include the trash enclosure detail, updating the labeling of the water main, and technical comments to be reflected on the plan and the minor plat.

Discussion
& Vote
4/28/2021

Cedar Falls Planning and Zoning Commission

April 28, 2021

Item 4.

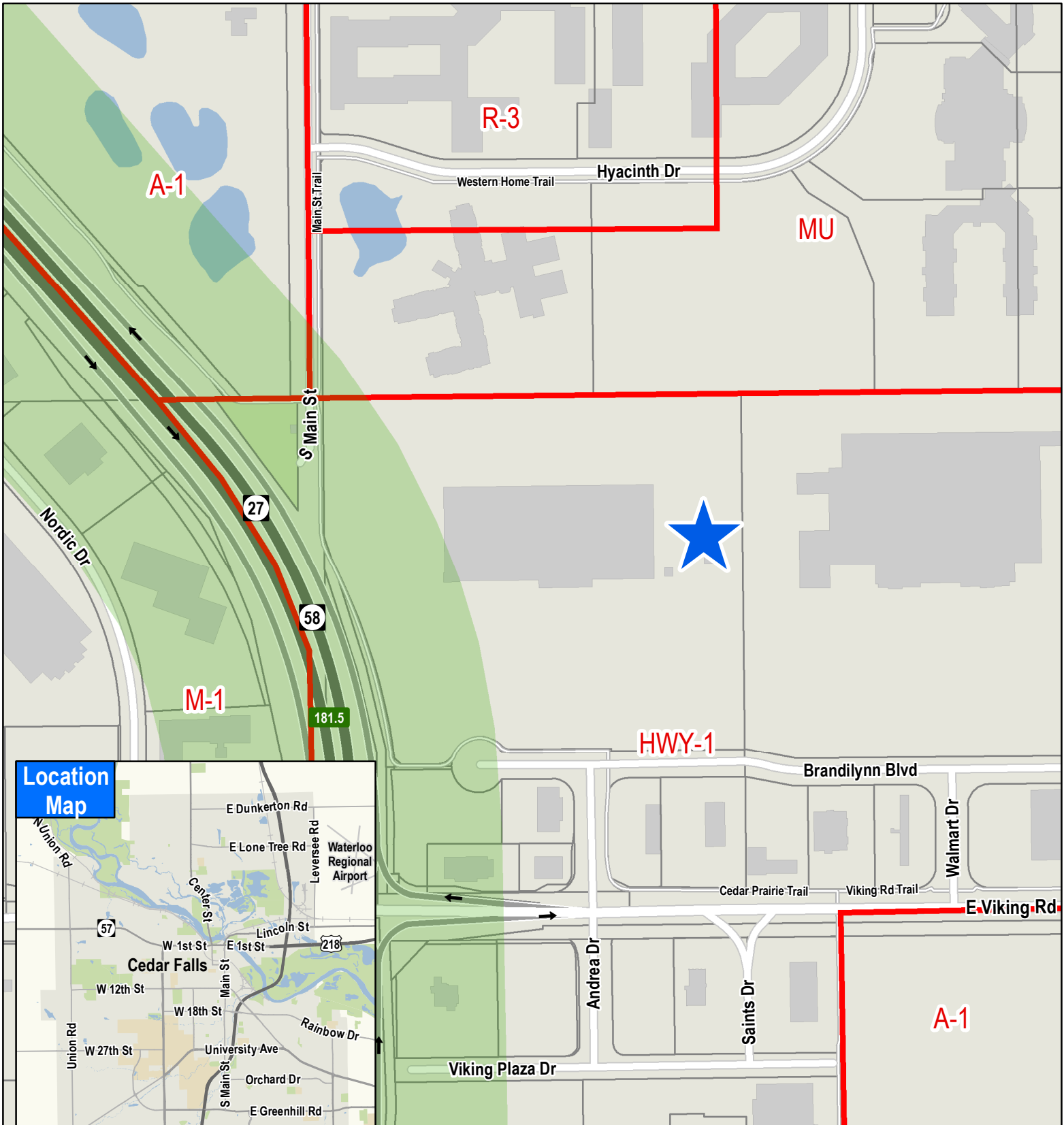

Location Map

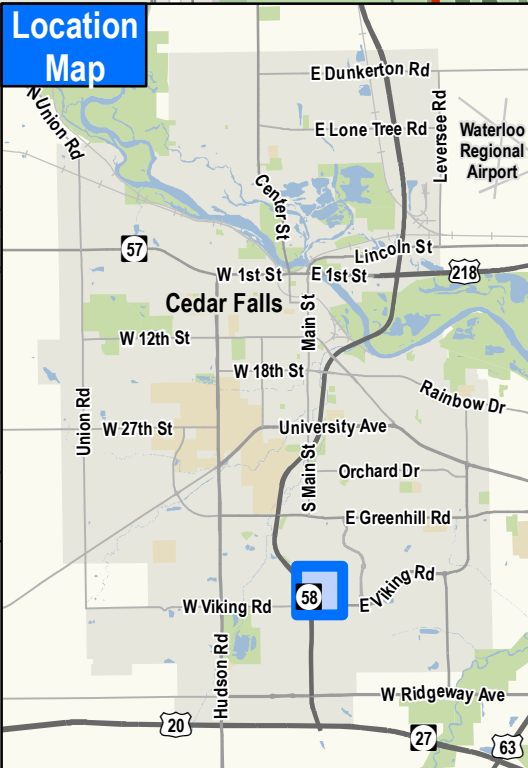

New Aldi's Grocery Store Site Plan

315 Brandilynn Blvd.



CITY OF CEDAR FALLS, IOWA

LOCATION MAP

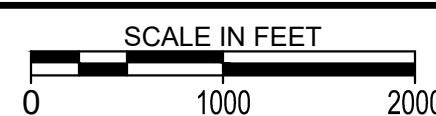

CIVIL PLAN ABBREVIATIONS:

AC	ACRE	CJ	CONTROL JOINT	EOF	EMERGENCY OVERFLOW	GPM	GALLONS PER MINUTE	J-BOX	JUNCTION BOX	OC	ON CENTER	REBAR	REINFORCING BAR	TRANS	TRANSFORMER
ADA	AMERICANS WITH DISABILITIES ACT	CL	CENTERLINE	EQ	EQUAL	GV	GATE VALVE	JT	JOINT	OCEW	ON CENTER EACH WAY	REM	REMOVE	TV	TELEVISION
ADD	ADDENDUM	CMP	CORRUGATED METAL PIPE	EX	EXISTING	HDPE	HIGH DENSITY POLYETHYLENE	LF	LINEAR FEET	OH	OVERHEAD	ROW	RIGHT OF WAY	T/W	TOP OF WALL
AFF	ABOVE FINISHED FLOOR	CO	CLEANOUT	FDC	FIRE DEPARTMENT CONNECTION	HD	HANDHOLE	LN	LINEAR	OHD	OVERHEAD DOOR	R/W	RIGHT OF WAY	TYP	TYPICAL
AGG	AGGREGATE	CONC	CONCRETE	FDN	FOUNDATION	HH	HANDHOLE	LPS	LOW PRESSURE STEAM	OZ	OUNCE	SAN	SANITARY	UT	UTILITY, UNDERGROUND
APPROX	APPROXIMATE	CONST	CONSTRUCTION	FFE	FINISHED FLOOR ELEVATION	HORIZ	HORIZONTAL	LS	LUMP SUM	PED	PEDESTAL, PEDESTRIAN	SCH	SCHEDULE	UT	UTILITY, UNDERGROUND
ARCH	ARCHITECT, ARCHITECTURAL	CONT	CONTINUOUS	PFM	FEET PER MINUTE	HR	HOUR	LSO	LOWEST STRUCTURAL OPENING	PERF	PERFORATED	SF	SQUARE FOOT	VCP	VITRIFIED CLAY PIPE
BFE	BASMENT FLOOR ELEVATION	CY	CUBIC YARD	FPS	FEET PER SECOND	HWL	HIGH WATER LEVEL	MAX	MAXIMUM	PL	PROPERTY LINE	SPEC	SPECIFICATION	W/O	WITHOUT
BIT	BITUMINOUS	C&G	CURB AND GUTTER	FT	FOOT, FEET	HWY	HIGHWAY	MB	MAIL BOX	PP	POLYPROPYLENE	SQ	SQUARE	W/	WITH
CAD	COMPUTER-AIDED DESIGN	DEMO	DEMOLITION	FTG	FOOTING	HYD	HYDRANT	MECH	MECHANICAL	PSI	POUNDS PER SQUARE INCH	STA	STATION	YD	YARD
CB	CATCH BASIN	DIA	DIAMETER	GAL	GALLON	IN	INCH	MH	MANHOLE	PVC	POLYVINYL CHLORIDE	SY	SQUARE YARD	YR	YEAR
CFS	CUBIC FEET PER SECOND	DIM	DIMENSION	GALV	GALVANIZED	MIN	MINIMUM	PVMT	PAVEMENT	QTY	QUANTITY	T/C	TOP OF CURB		
CF	CUBIC FOOT	DS	DOWNSPOUT	GC	GENERAL CONTRACTOR	IN	INCH	MISC	MISCELLANEOUS	RAD	RADIUS	TEL	TELEPHONE		
CI	CAST IRON	EA	EACH	GC	GENERAL CONTRACTOR	INV	INVERT	NO	NUMBER	RCP	REINFORCED CONCRETE PIPE	TEMP	TEMPORARY		
CIP	CAST IRON PIPE	ELEC	ELECTRICAL	GFE	GARAGE FLOOR ELEVATION	IP	IRON PIPE	NTS	NOT TO SCALE	RD	ROOF DRAIN	THRU	THROUGH		
CIPC	CAST IN PLACE CONCRETE	ELEV	ELEVATION	GL	GUTTER LINE	IPS	IRON PIPE SIZE	NWL	NORMAL WATER LEVEL			TNHF	TOP NUT OF FIRE HYDRANT		

PROJECT ADDRESS / LOCATION:

**219 BRANDILYNN BLVD
CEDAR FALLS, IOWA 50613**

**BLACKHAWK COUNTY
S25 T89N R14W**

SITE SUMMARY

ZONING:	HWY-1, HIGHWAY COMMERCIAL DISTRICT		
	ALDI SITE	BLAIN'S SITE	TOTAL SITE
SITE/LOT AREA:	192,252 SF / 4.413 AC.	731,739 SF / 16.799 AC.	923,991 SF / 21.212 AC.
IMPERVIOUS AREA:	128,066 SF / 2.940 AC.	634,974 SF / 14.577 AC.	763,040 SF / 17.517 AC.
GREENSPACE PROVIDED:	64,144 SF / 1.473 AC.	96,806 SF / 2.222 AC.	160,950 SF / 3.695 AC.
PARKING REQUIREMENTS (PER CITY CODE)			
TYPE	UNIT / AREA	STALLS REQUIRED	STALLS PROVIDED
10'x20'	4.5 / 1000 SF	92	166
ADA ACCESSIBLE		6	6
TOTAL:			172
SETBACKS			
		PARKING	BUILDING
FRONT YARD		20'-0"	30'-0"
SIDE YARD		20'-0"	20'-0"
REAR YARD		20'-0"	20'-0"

PROJECT GENERAL NOTES

- ALL WORK SHALL CONFORM TO THE CONTRACT DOCUMENTS, WHICH INCLUDE, BUT ARE NOT LIMITED TO, THE OWNER - CONTRACTOR AGREEMENT, THE PROJECT MANUAL (WHICH INCLUDES GENERAL SUPPLEMENTARY CONDITIONS AND SPECIFICATIONS), DRAWINGS OF ALL DISCIPLINES AND ALL ADDENDA, MODIFICATIONS AND CLARIFICATIONS ISSUED BY THE ARCHITECT/ENGINEER.
- CONTRACT DOCUMENTS SHALL BE ISSUED TO ALL SUBCONTRACTORS BY THE GENERAL CONTRACTOR IN COMPLETE SETS IN ORDER TO ACHIEVE THE FULL EXTENT AND COMPLETE COORDINATION OF ALL WORK.
- WRITTEN DIMENSIONS TAKE PRECEDENCE OVER SCALED DIMENSIONS. NOTIFY ENGINEER OF ANY DISCREPANCIES OR CONDITIONS REQUIRING INFORMATION OR CLARIFICATION BEFORE PROCEEDING WITH THE WORK.
- FIELD VERIFY ALL EXISTING CONDITIONS AND DIMENSIONS. NOTIFY ENGINEER OF ANY DISCREPANCIES OR CONDITIONS REQUIRING INFORMATION OR CLARIFICATION BEFORE PROCEEDING WITH THE WORK.
- DETAILS SHOWN ARE INTENDED TO BE INDICATIVE OF THE PROFILES AND TYPE OF DETAILING REQUIRED THROUGHOUT THE WORK. DETAILS NOT SHOWN ARE SIMILAR IN CHARACTER TO DETAILS SHOWN, WHERE SPECIFIC DIMENSIONS, DETAILS OR DESIGN INTENT CANNOT BE DETERMINED, NOTIFY ENGINEER BEFORE PROCEEDING WITH THE WORK.
- ALL MANUFACTURED ARTICLES, MATERIALS AND EQUIPMENT SHALL BE APPLIED, INSTALLED, CONNECTED, ERECTED, CLEANED AND CONDITIONED ACCORDING TO MANUFACTURERS' INSTRUCTIONS. IN CASE OF DISCREPANCIES BETWEEN MANUFACTURERS' INSTRUCTIONS AND THE CONTRACT DOCUMENTS, NOTIFY ENGINEER BEFORE PROCEEDING WITH THE WORK.
- ALL DISSIMILAR METALS SHALL BE EFFECTIVELY ISOLATED FROM EACH OTHER TO AVOID GALVANIC CORROSION.
- THE LOCATION AND TYPE OF ALL INPLACE UTILITIES SHOWN ON THE PLANS ARE FOR GENERAL INFORMATION ONLY AND ARE ACCURATE AND COMPLETE TO THE BEST OF THE KNOWLEDGE OF I & S GROUP, INC. (ISG). NO WARRANTY OR GUARANTEE IS IMPLIED. THE CONTRACTOR SHALL VERIFY THE SIZES, LOCATIONS AND ELEVATIONS OF ALL INPLACE UTILITIES PRIOR TO CONSTRUCTION. CONTRACTOR SHALL IMMEDIATELY NOTIFY ENGINEER OF ANY DISCREPANCIES OR VARIATIONS FROM PLAN.
- THE CONTRACTOR IS TO CONTACT "IOWA ONE CALL" FOR UTILITY LOCATIONS, MINIMUM 2 BUSINESS DAYS PRIOR TO ANY EXCAVATION / CONSTRUCTION (1-800-292-8989).

SPECIFICATIONS REFERENCE

ALL CONSTRUCTION SHALL COMPLY WITH THE CITY OF CEDAR FALLS REQUIREMENTS AND WITH THE 2018 EDITION OF THE STATEWIDE URBAN DESIGN AND SPECIFICATIONS (SUDAS) FOR PUBLIC IMPROVEMENTS, UNLESS DIRECTED OTHERWISE.

PROJECT DATUM

HORIZONTAL COORDINATES HAVE BEEN REFERENCED TO THE NORTH AMERICAN DATUM OF 1983 (NAD83), ZONE, ON THE IA RCS ZONE 5 COORDINATE SYSTEM, IN U.S. SURVEY FEET. ELEVATIONS HAVE BEEN REFERENCED TO THE NORTH AMERICAN VERTICAL DATUM OF 1988 (NAVD 88). RTK GPS METHODS WERE USED TO ESTABLISH HORIZONTAL AND VERTICAL COORDINATES FOR THIS PROJECT.

TOPOGRAPHIC SURVEY

THIS PROJECT'S TOPOGRAPHIC SURVEY CONSISTS OF DATA COLLECTED IN JANUARY / 2021 BY ISG, INC.

CONSTRUCTION STAKING

OWNER TO PROVIDE 10 TRIPS TO THE CONSTRUCTION SITE FOR STAKING PURPOSES. STAKING SHALL INCLUDE ANY COMBINATION OF THE FOLLOWING: GRIDLINES WITH OFFSETS, ROUGH GRADE STAKING, UTILITIES, CURB & GUTTER, LIGHT POLES, SIGNS, SIDEWALK. ANY ADDITIONAL SURVEY WORK NEEDED OR REQUIRED SHALL BE THE CONTRACTOR'S RESPONSIBILITY TO EMPLOY AND PAY ISG, INC. CONTACT RYAN ANDERSON WITH ISG, INC. AT (952) 426-0699 FOR PRICING INFORMATION.

B.M. ELEVATION=964.26

TNHF LOCATED 17 FEET BACK OF SOUTH CURB LINE OF BRANDILYNN BLVD. APPROXIMATELY 75 FEET SOUTH OF THE SOUTHEAST PROPERTY CORNER

LEGEND

EXISTING		CITY LIMITS
---		SECTION LINE
---		QUARTER SECTION LINE
---		RIGHT OF WAY LINE
---		PROPERTY / LOT LINE
---		EASEMENT LINE
---		ACCESS CONTROL
---		WATER EDGE
---		WETLAND BOUNDARY
---		WETLAND / MARSH
---		FENCE LINE
---		CULVERT
---		STORM SEWER
---		SANITARY SEWER
---		SANITARY SEWER FORCEMAIN
---		WATER
---		GAS
---		OVERHEAD ELECTRIC
---		UNDERGROUND ELECTRIC
---		UNDERGROUND TELEPHONE
---		UNDERGROUND TV
---		OVERHEAD UTILITY
---		UNDERGROUND UTILITY
---		UNDERGROUND FIBER OPTIC
---		CONTOUR (MAJOR)
---		CONTOUR (MINOR)
---		DECIDUOUS TREE
---		CONIFEROUS TREE
---		TREE LINE
---		MANHOLE/STRUCTURE
---		CATCH BASIN
---		HYDRANT
---		VALVE
---		CURB STOP
---		POWER POLE
---		UTILITY PEDESTAL / CABINET
PROPOSED		LOT LINE
---		RIGHT OF WAY
---		EASEMENT
---		CULVERT
---		STORM SEWER
---		STORM SEWER (PIPE WIDTH)
---		SANITARY SEWER
---		SANITARY SEWER (PIPE WIDTH)
---		WATER
---		GAS
---		OVERHEAD ELECTRIC
---		UNDERGROUND ELECTRIC
---		UNDERGROUND TV
---		CONTOUR
---		MANHOLE
---		CATCH BASIN
---		HYDRANT
---		VALVE

CIVIL SHEET INDEX

- C-010 SITE DATA
- C-020 SITE DETAILS
- C-021 SITE DETAILS
- C-022 SITE DETAILS
- C-023 SITE DETAILS
- C-024 SITE DETAILS
- C-025 PYLON SIGN DETAILS
- C-110 SITE EROSION CONTROL PLAN
- C-120 SITE EROSION CONTROL DETAILS
- C-210 EXISTING SITE & REMOVAL PLAN
- C-300 OVERALL SITE PLAN
- C-310 SITE PLAN
- C-320 SITE UTILITY PLAN
- C-321 BUILDING DETAIL PLAN
- C-410 SITE GRADING PLAN
- C-420 BUILDING GRADING PLAN
- C-510 SITE RESTORATION & PLANTING PLAN
- C-520 SITE PLANTING NOTES & DETAILS
- C-610 SITE LIGHTING PHOTOMETRICS PLAN
- C-620 SIGHT LIGHTING CATALOGUE PAGES

Issued: _____ Date: _____

A	SITE PLAN SUBMITTAL	02/19/21
B	PERMIT SET	03/19/21
C	BID SET	04/05/21
D		
E		

Revisions:	Date:
1	
2	
3	
4	
5	
6	
7	
8	
9	



MANAGING LOCATION:
MINNEAPOLIS / ST. PAUL OFFICE
7900 INTERNATIONAL DRIVE
INTERNATIONAL PLAZA, SUITE 550
MINNEAPOLIS, MN 55425
PHONE: 952.426.0699



ALDI Inc. Store #: 64
CEDAR FALLS, IA
219 BRANDILYNN BLVD
CEDAR FALLS, IA 50613
BLACKHAWK COUNTY
Project Name & Location:

SITE DATA

Drawing Name:	ISG Project No.
Type: v7.0 ER	16-19997
Drawn By: JMF	C-010
Designed By: JMF	Drawing No.
Reviewed By: RJA	

SEAL

I HEREBY CERTIFY THAT THIS ENGINEERING DOCUMENT WAS PREPARED BY ME OR UNDER MY DIRECT PERSONAL SUPERVISION AND THAT I AM A DULY LICENSED PROFESSIONAL ENGINEER UNDER THE LAWS OF THE STATE OF IOWA.

ANDREW T. BRANDEL

PRINTED SIGNATURE: _____ 04/20/21
SIGNATURE: *Andrew T. Brandel* SIGNATURE DATE

12-31-2021
REGISTRATION EXPIRES

SHEETS COVERED BY THIS SEAL C-010 - C-620

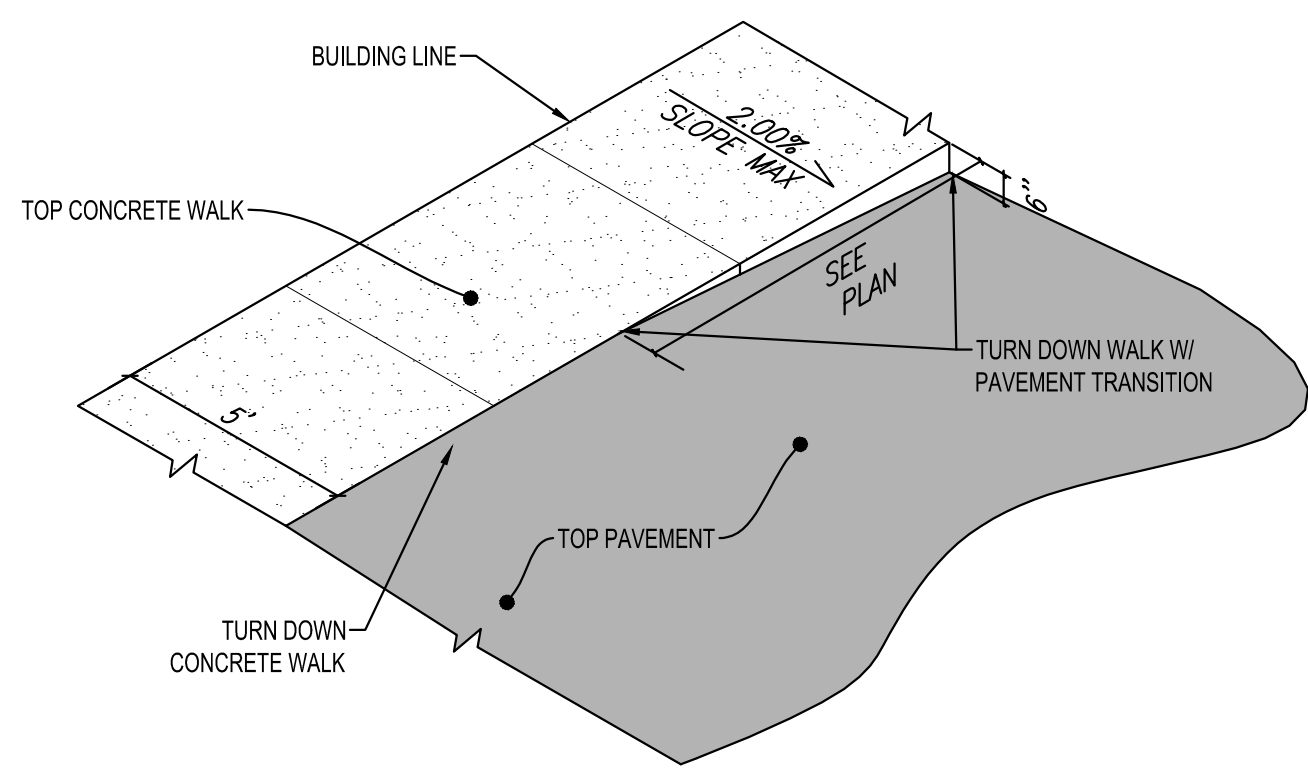

TURN DOWN WALK TRANSITION
N.T.S.

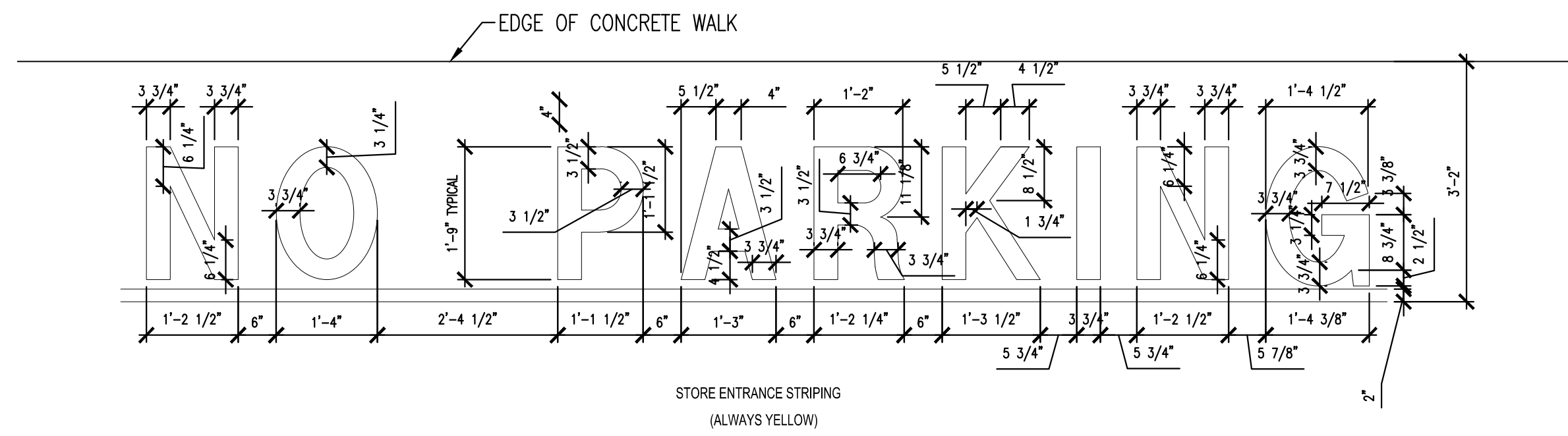

STORE ENTRANCE NO PARKING STRIPING DETAIL
N.T.S.

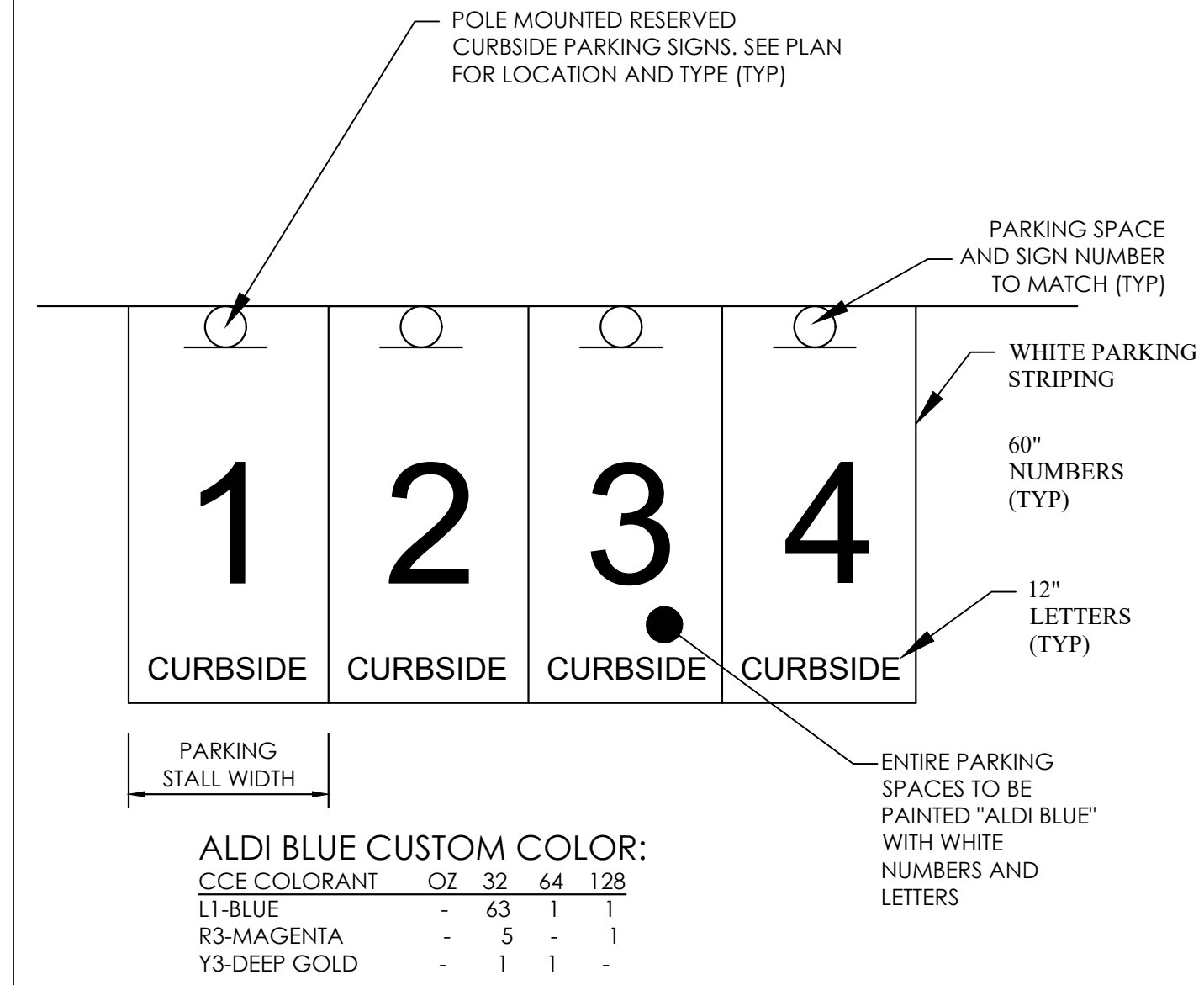

ALDI BLUE CUSTOM COLOR:
CCE COLORANT OZ 32 64 128
L1-BLUE - 63 1 1
R3-MAGENTA - 5 - 1
Y3-DEEP GOLD - 1 1 -

- ARIAL BOLD FONT SHALL BE USED FOR NUMBERS AND LETTERS
- PAINT SHALL BE SEALMASTERS 'COLOR PAVE' OR 'LIQUID THERMOPLASTIC' TRAFFIC MARKING PAINT OR AS APPROVED BY ALDI C.M. CONTACT ROCHESTER JET-BLACK, GARY ROSSBROOK, 585-441-4125 FOR ORDERING.
- a. COLOR PAVE SHALL BE USED FOR NEW PAVEMENT
- b. LIQUID THERMOPLASTIC SHALL BE USED FOR OLDER PAVEMENT THAT HAS BEEN SEALED WITH A COAL TAR SEALER.
- SURFACE PREPARATION SHALL COMPLY WITH MANUFACTURERS REQUIREMENTS.
- SIGNS, NUMBERS AND WORDING TO BE PLACED CENTERED

CURBSIDE PARKING DETAIL
N.T.S.

Issued:	Date:
A SITE PLAN SUBMITTAL	02/19/21
B PERMIT SET	03/19/21
C BID SET	04/05/21
D	
E	
Revisions:	Date:
1	
2	
3	
4	
5	
6	
7	
8	
9	



MANAGING LOCATION:
MINNEAPOLIS / ST. PAUL OFFICE
7900 INTERNATIONAL DRIVE
INTERNATIONAL PLAZA, SUITE 550
MINNEAPOLIS, MN 55425
PHONE: 952.426.0699



ALDI Inc. Store #: 64
CEDAR FALLS, IA
219 BRANDILYNN BLVD
CEDAR FALLS, IA 50613
BLACKHAWK COUNTY
Project Name & Location:

SITE DETAILS

Drawing Name:	ISG Project No.
Type: V7.0 ER	16-19997
Drawn By: JMF	
Designed By: JMF	C-020
Reviewed By: RJA	Drawing No.

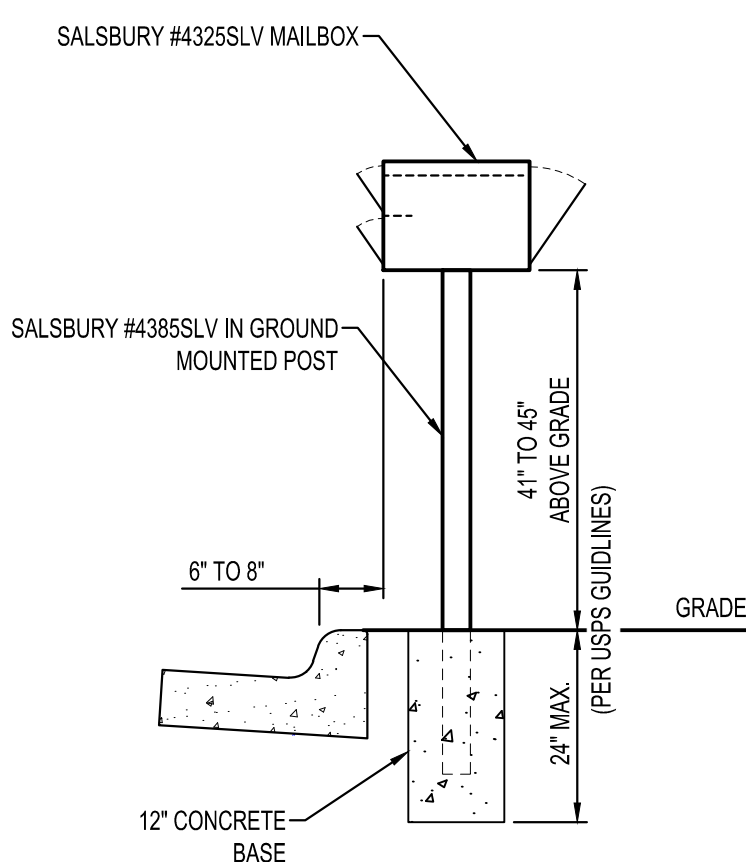

ALDI MAILBOX W/ POST
N.T.S.

*COORDINATE FINAL LOCATION WITH ALDI CONSTRUCTION MANAGER

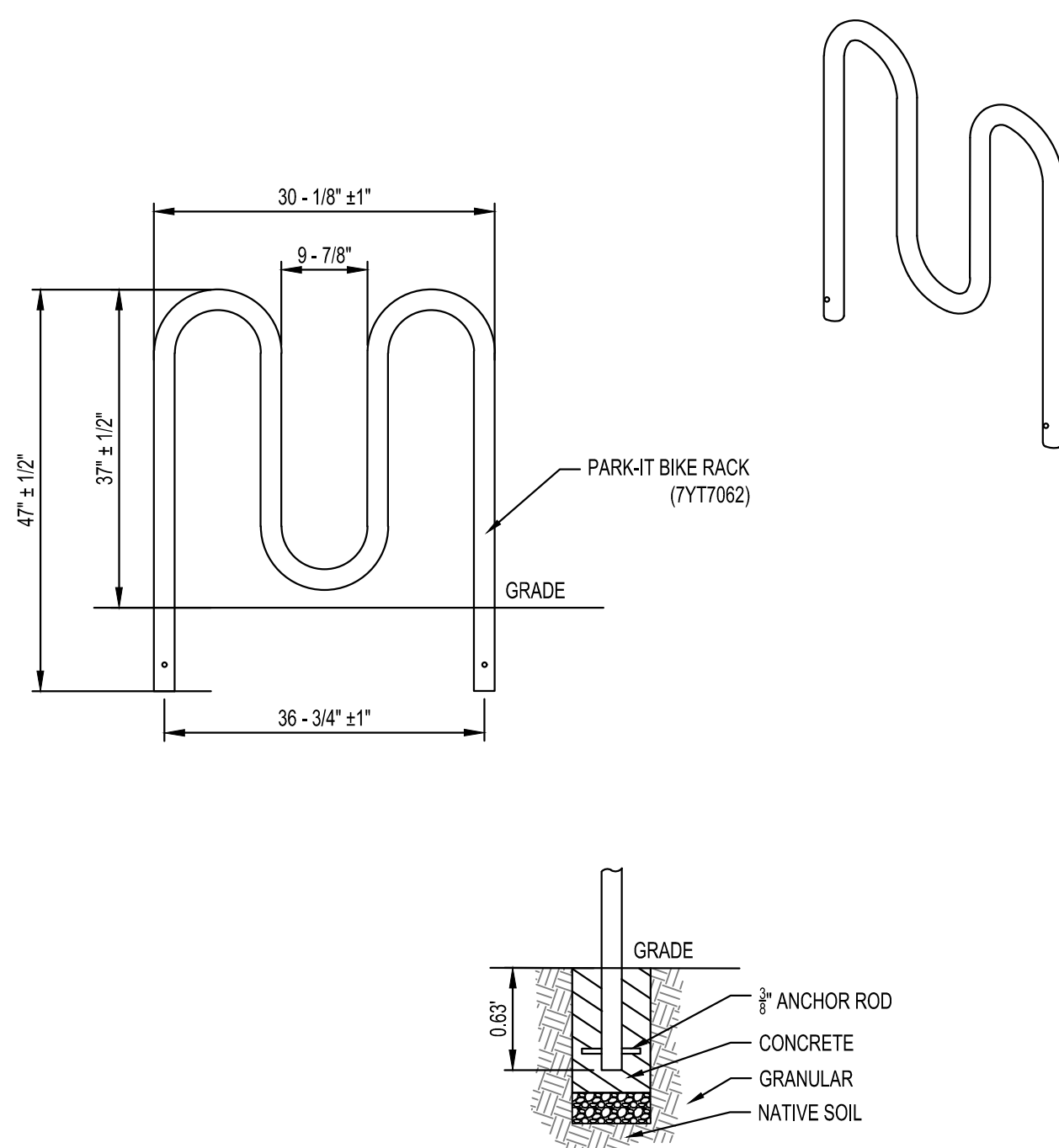

PARK-IT BIKE RACK (5 BIKES)
N.T.S.

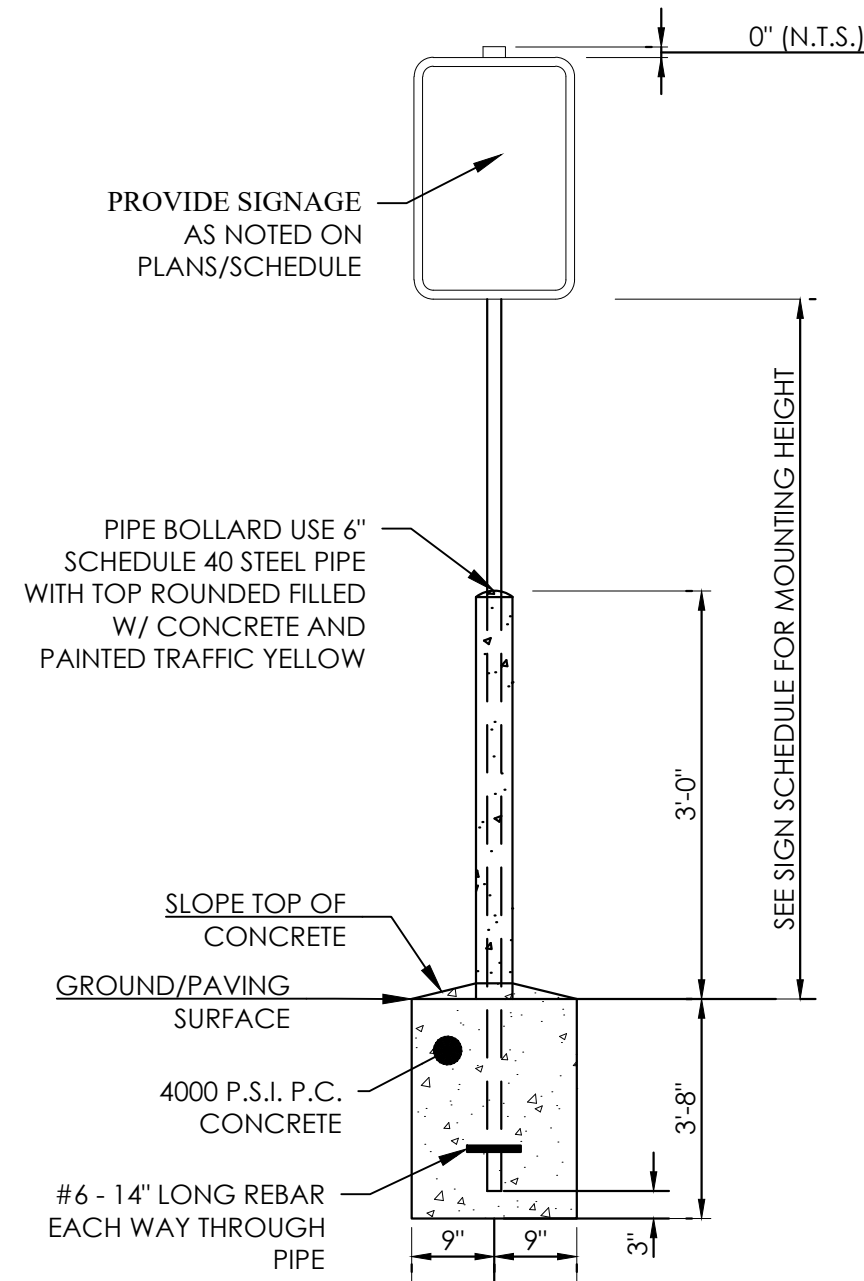

SIGN POST W/ BOLLARD DETAIL
N.T.S.

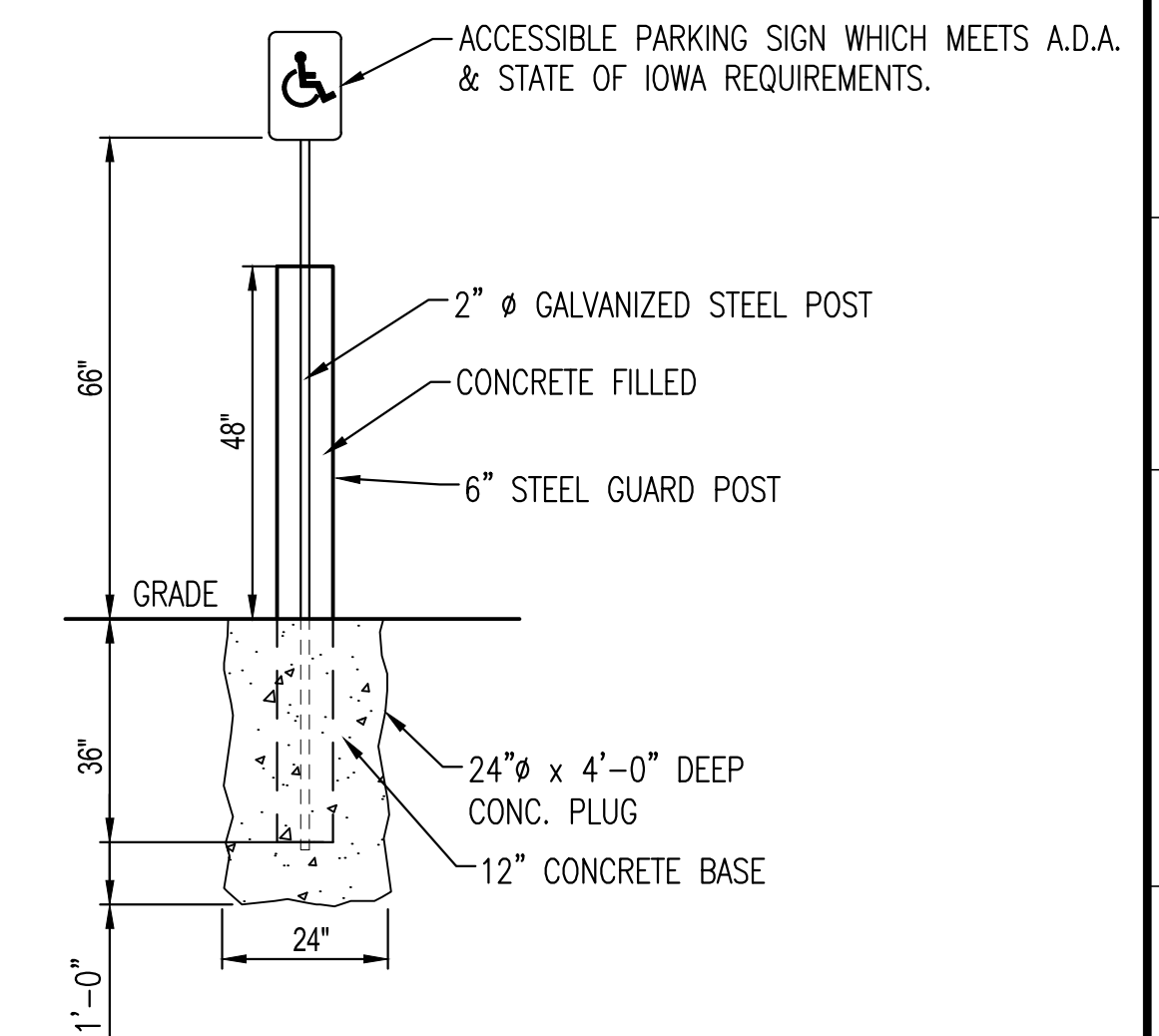

ACCESSIBLE PARKING SIGN POST W/BOLLARD
N.T.S.

Issued:	Date:
A SITE PLAN SUBMITTAL	02/19/21
B PERMIT SET	03/19/21
C BID SET	04/05/21
D	
E	
Revisions:	Date:
1	
2	
3	
4	
5	
6	
7	
8	
9	

NOTES:
 GRIND EXPOSED FIELD & SHOP WELDS FLUSH WITH ADJACENT SURFACES.
 AFTER FABRICATION, GALVANIZE STRUCTURAL SHAPES AND MISCELLANEOUS ITEMS IN ACCORDANCE WITH ASTM A123.
 REPAIR DAMAGED & SCRATCHED GALVANIZED COATINGS AFTER INSTALLATION
 GROUT AROUND ALL PIPES ON INSIDE AND OUTSIDE OF MANHOLE

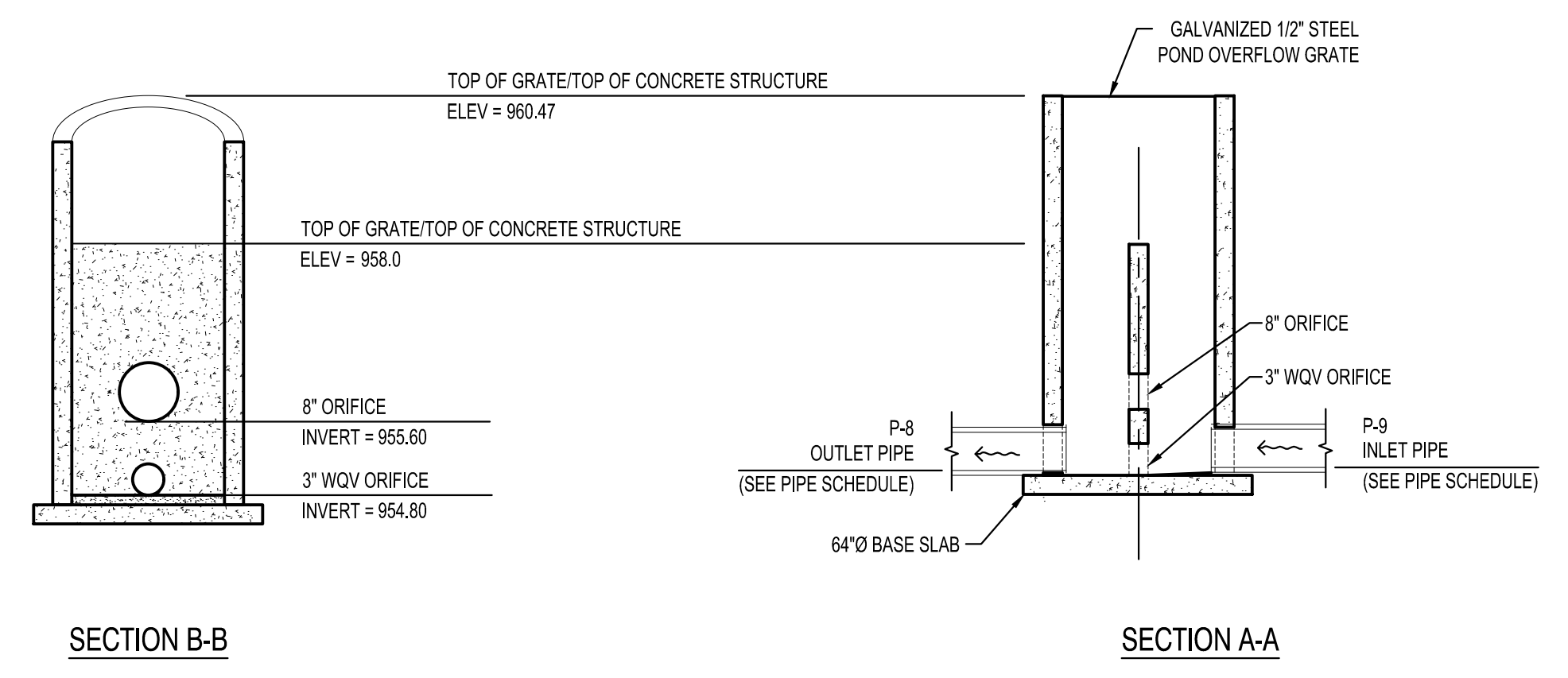
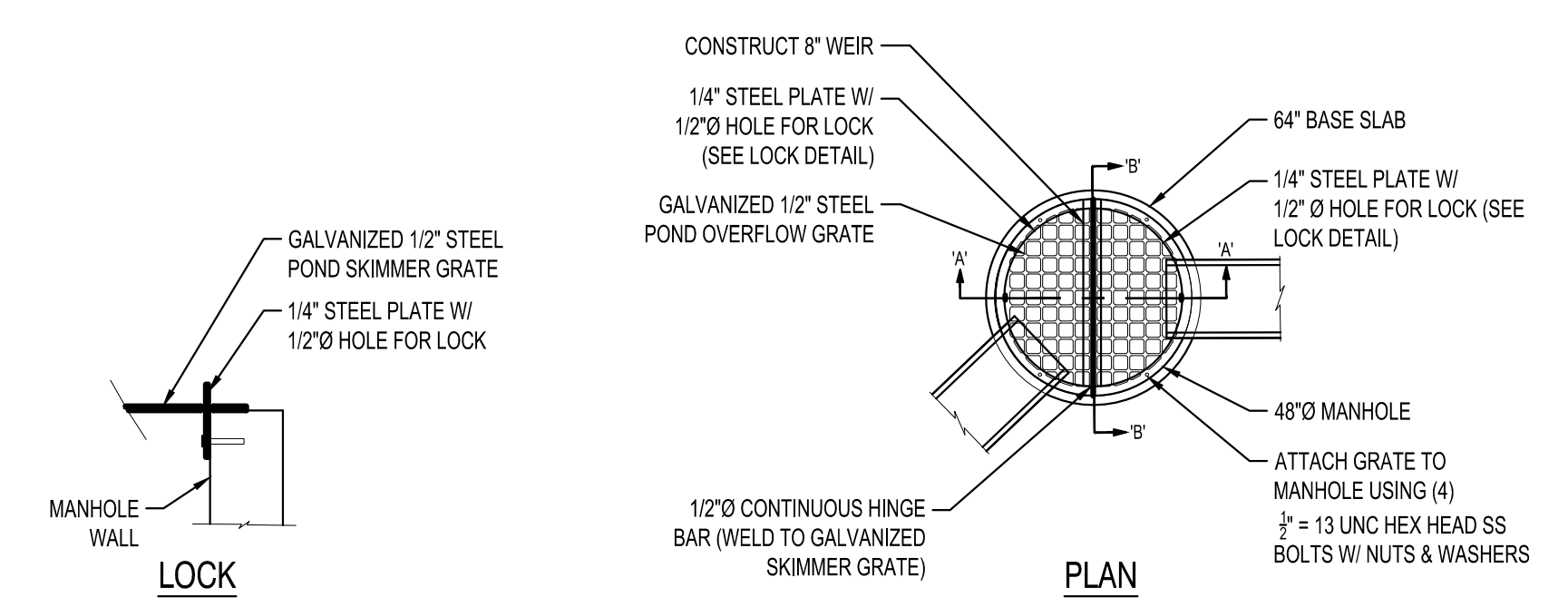

**A-3 (SW-401)
 POND OUTLET STRUCTURE**
 NTS

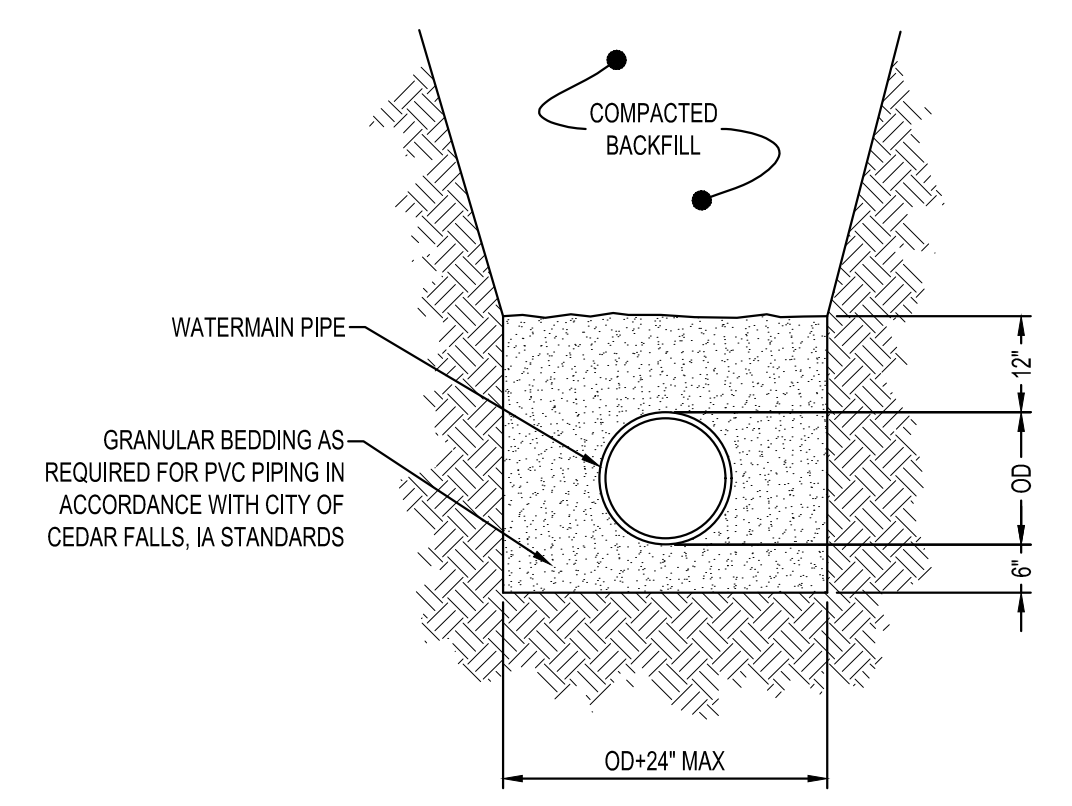

NOTE:
 GRANULAR BEDDING AND ENCASEMENT FOR WATERMAIN PIPES SHALL BE INCIDENTAL TO CONSTRUCTION

**PIPE BEDDING
 WATER MAIN**
 NTS WM300

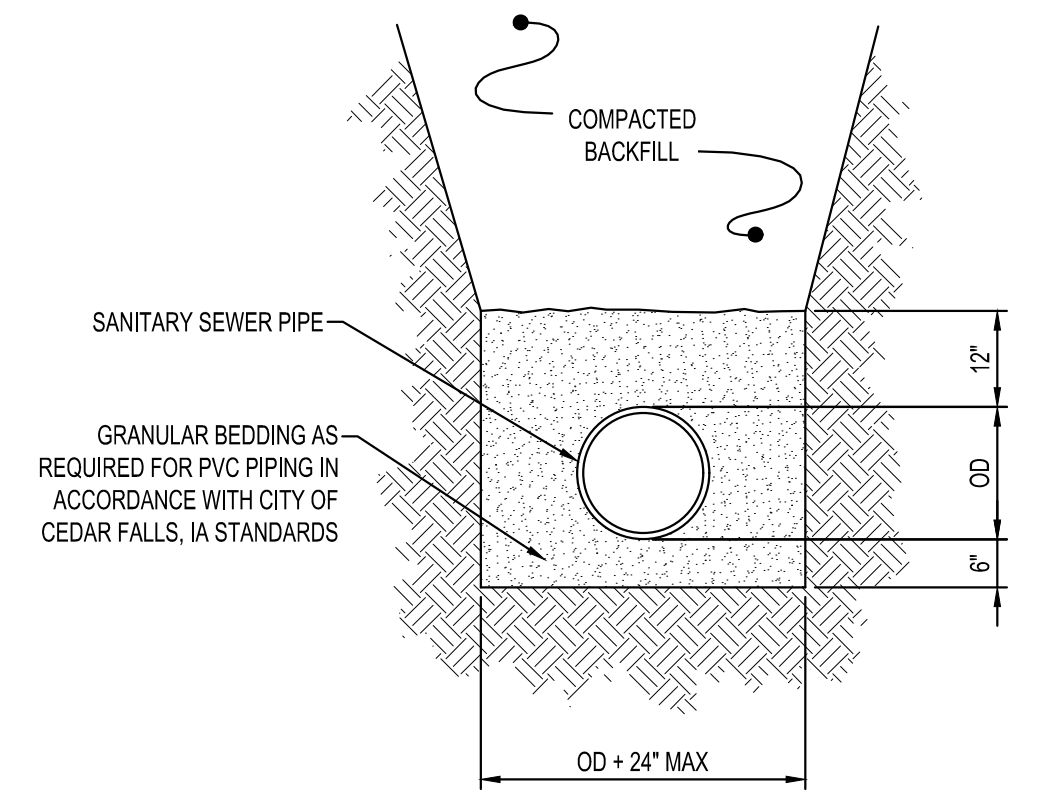

NOTES:
 GRANULAR BEDDING AND ENCASEMENT FOR SANITARY SEWER PIPES SHALL BE INCIDENTAL TO CONSTRUCTION

**PIPE BEDDING
 SANITARY SEWER**
 NTS SA400

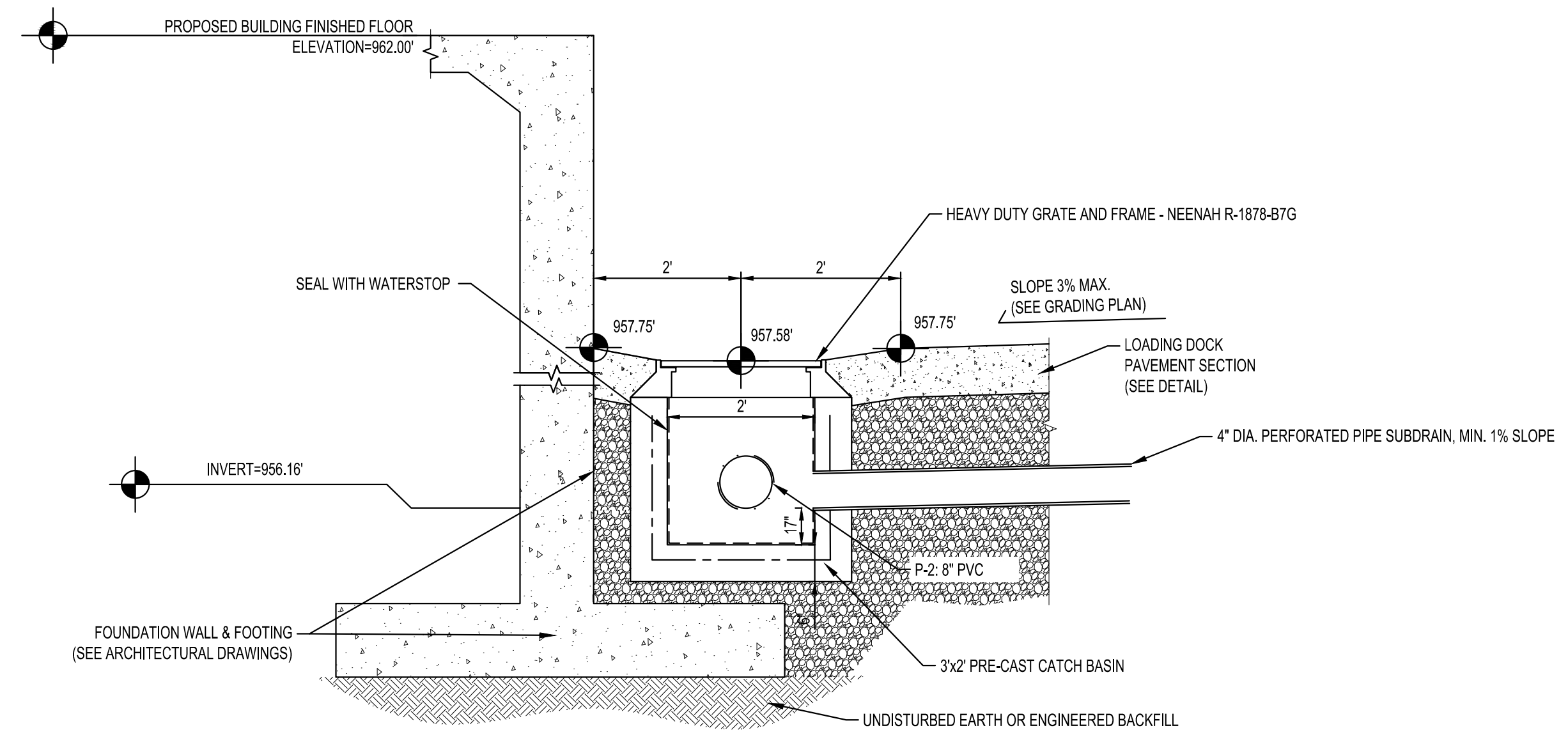

LOADING DOCK CATCH BASIN A-2 DETAIL
 N.T.S.

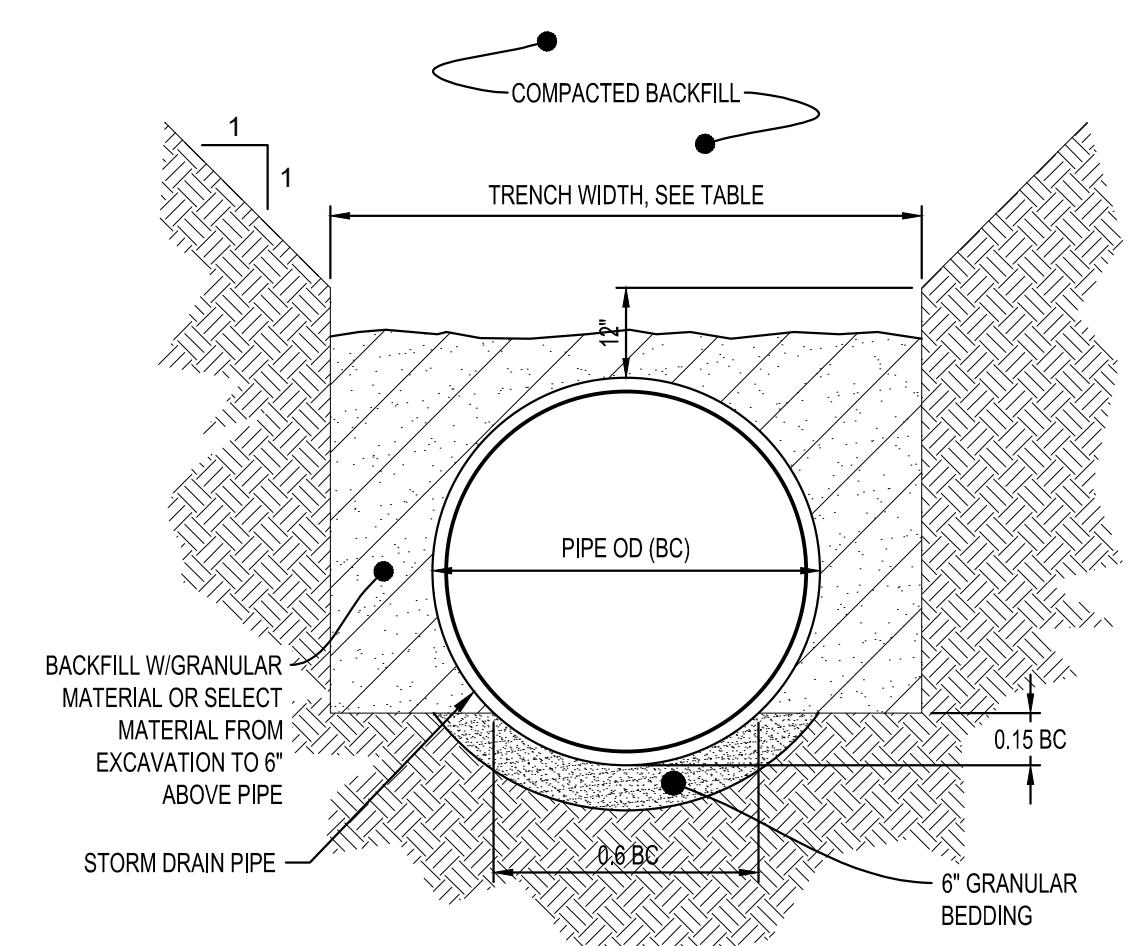

TRENCH WIDTH	
PIPE Ø	TRENCH WIDTH
36" OR LESS	BC + 24"
42" TO 54"	1.5 x BC
60" OR OVER	BC + 36"

NOTES:
 GRANULAR BEDDING AND BACKFILL FOR STORM DRAIN PIPES SHALL BE INCIDENTAL TO STORM DRAIN CONSTRUCTION

**NON-CONCRETE
 STORM DRAIN PIPE BEDDING**
 NTS SD600

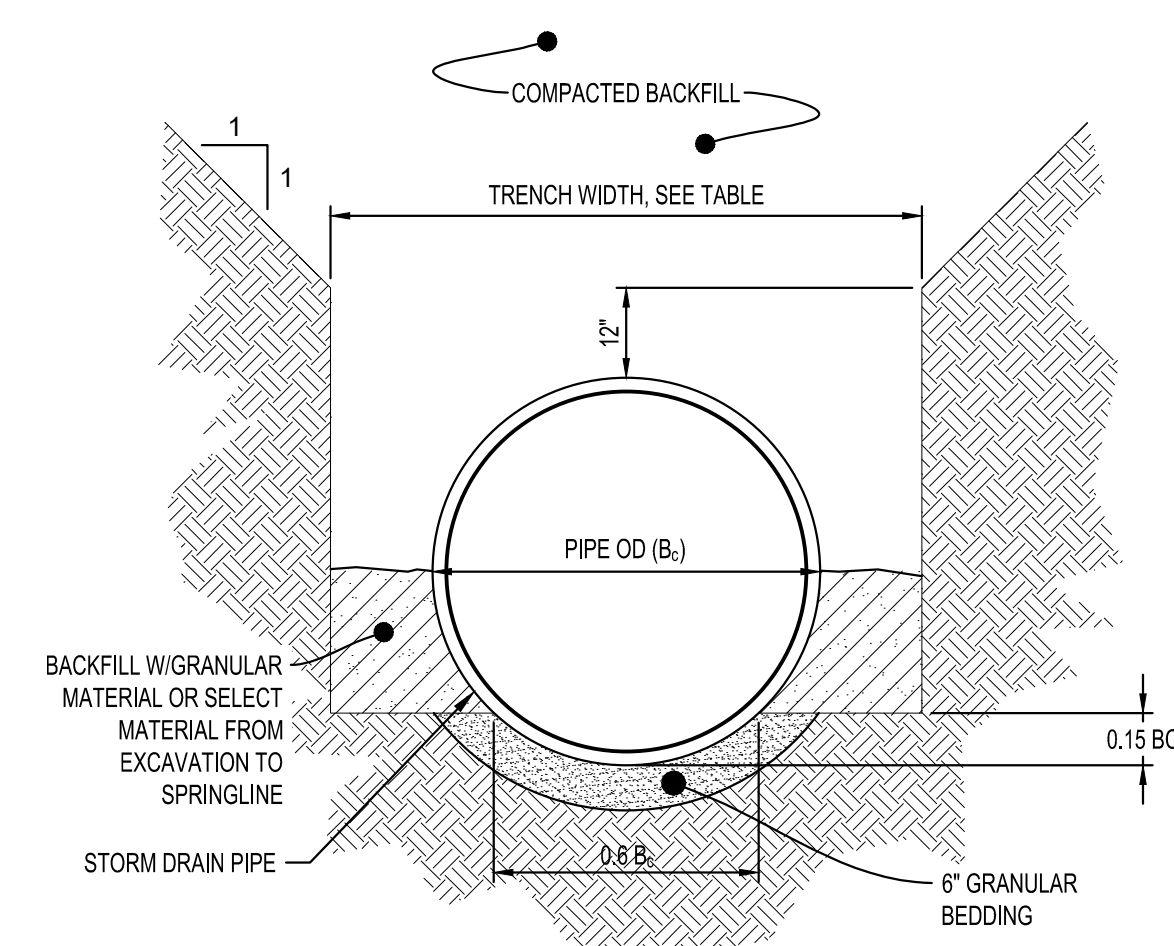

TRENCH WIDTH	
PIPE Ø	TRENCH WIDTH
36" OR LESS	B _c + 24"
42" TO 54"	1.5 x B _c
60" OR OVER	B _c + 36"

NOTES:
 GRANULAR BEDDING AND BACKFILL FOR STORM DRAIN PIPES SHALL BE INCIDENTAL TO STORM DRAIN CONSTRUCTION

**REINFORCED CONCRETE
 STORM DRAIN PIPE BEDDING**
 NTS SD601



MANAGING LOCATION:
MINNEAPOLIS / ST. PAUL OFFICE
 7900 INTERNATIONAL DRIVE
 INTERNATIONAL PLAZA, SUITE 550
 MINNEAPOLIS, MN 55425
 PHONE: 952.426.0699

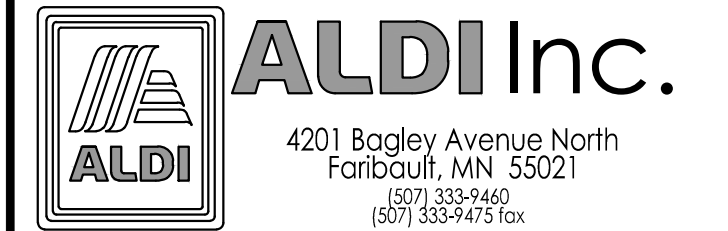

ALDI Inc. Store #: 64
CEDAR FALLS, IA
 219 BRANDILYNN BLVD
 CEDAR FALLS, IA 50613
 BLACKHAWK COUNTY
 Project Name & Location:

SITE DETAILS

Drawing Name:	ISG Project No.
Type: V7.0 ER	16-19997
Drawn By: JMF	
Designed By: JMF	C-021
Reviewed By: RJA	Drawing No.

Issued:		Date:
A	SITE PLAN SUBMITTAL	02/19/21
B	PERMIT SET	03/19/21
C	BID SET	04/05/21
D		
E		
Revisions:		Date:
1		
2		
3		
4		
5		
6		
7		
8		
9		

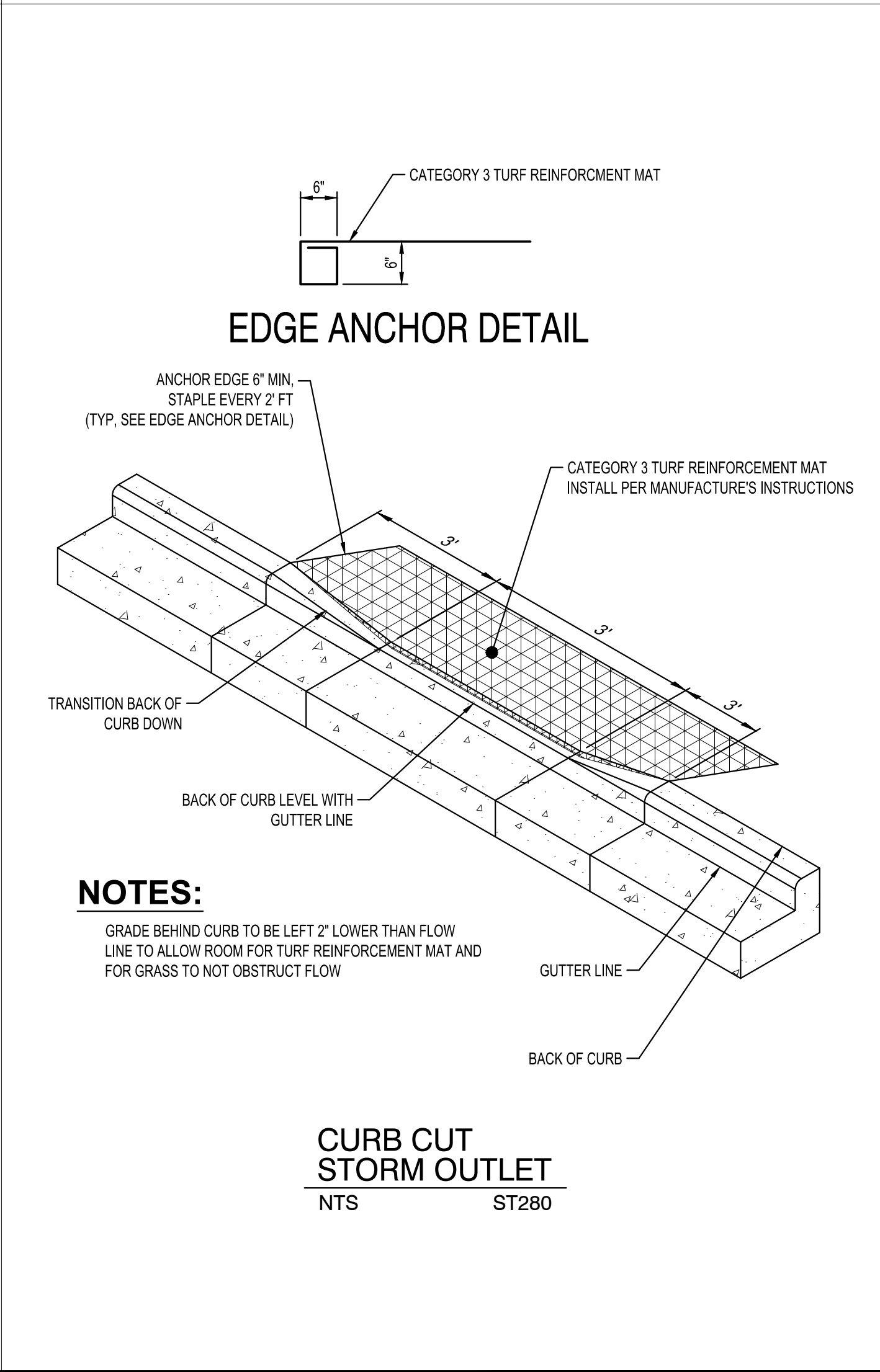
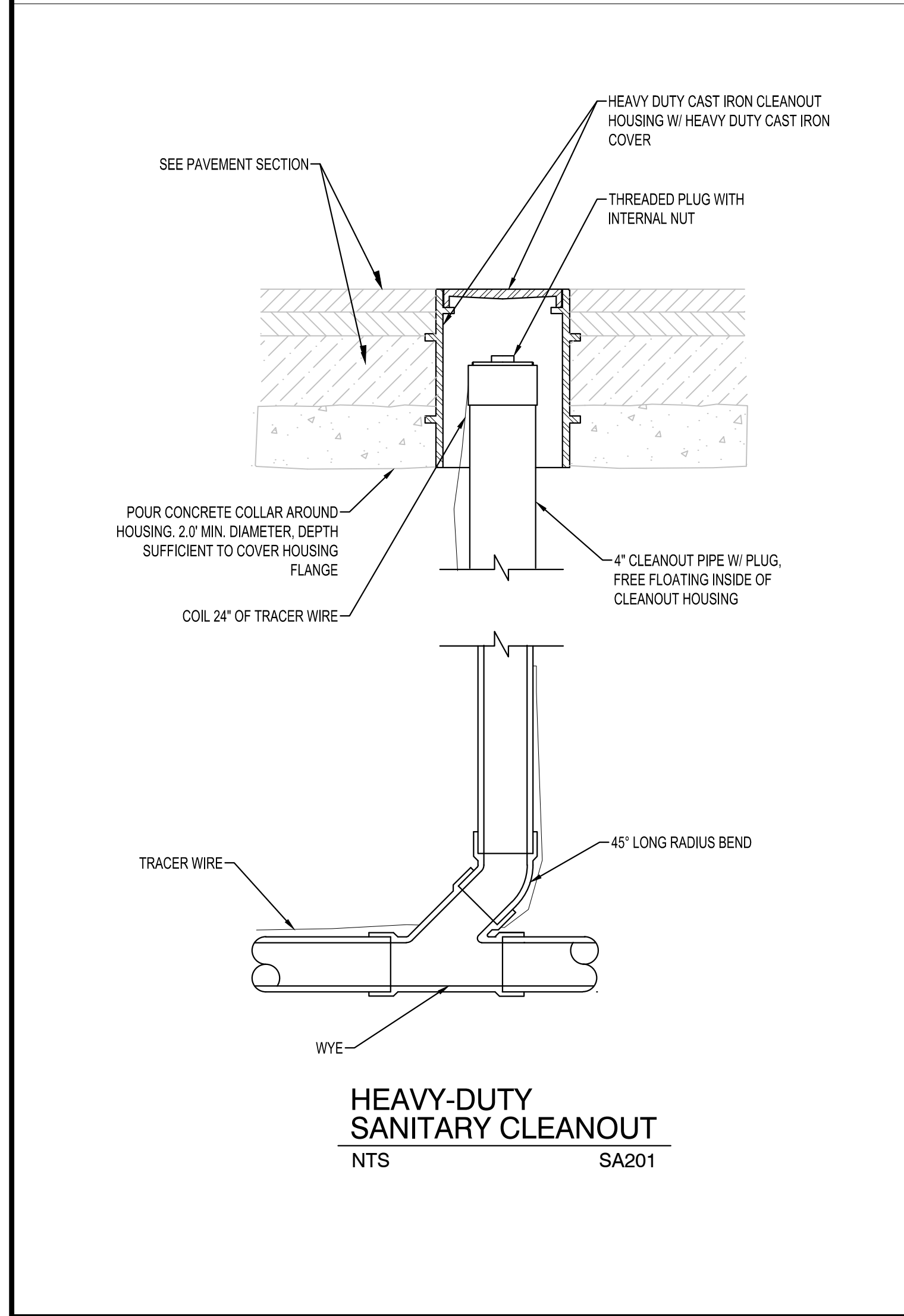
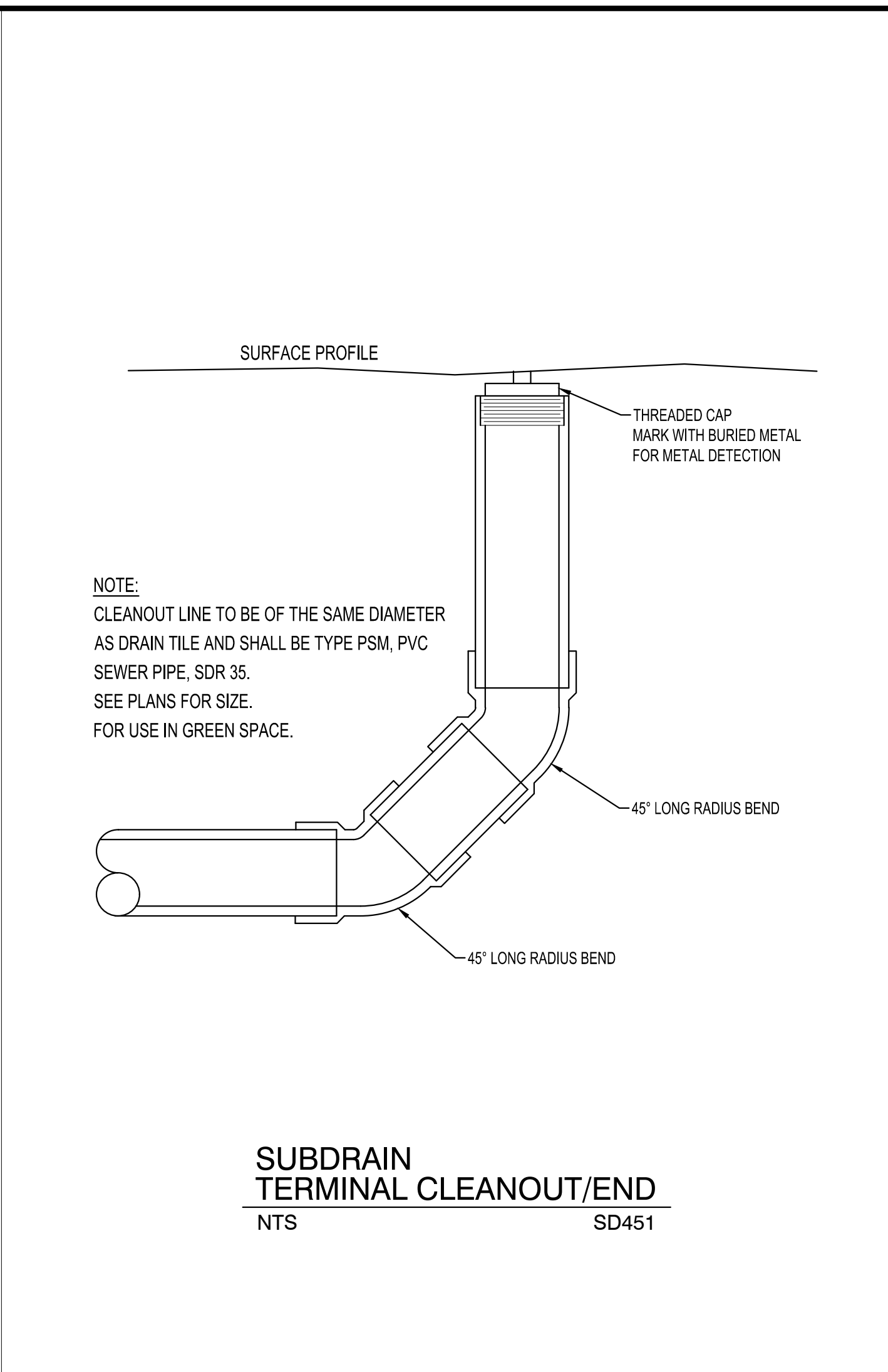
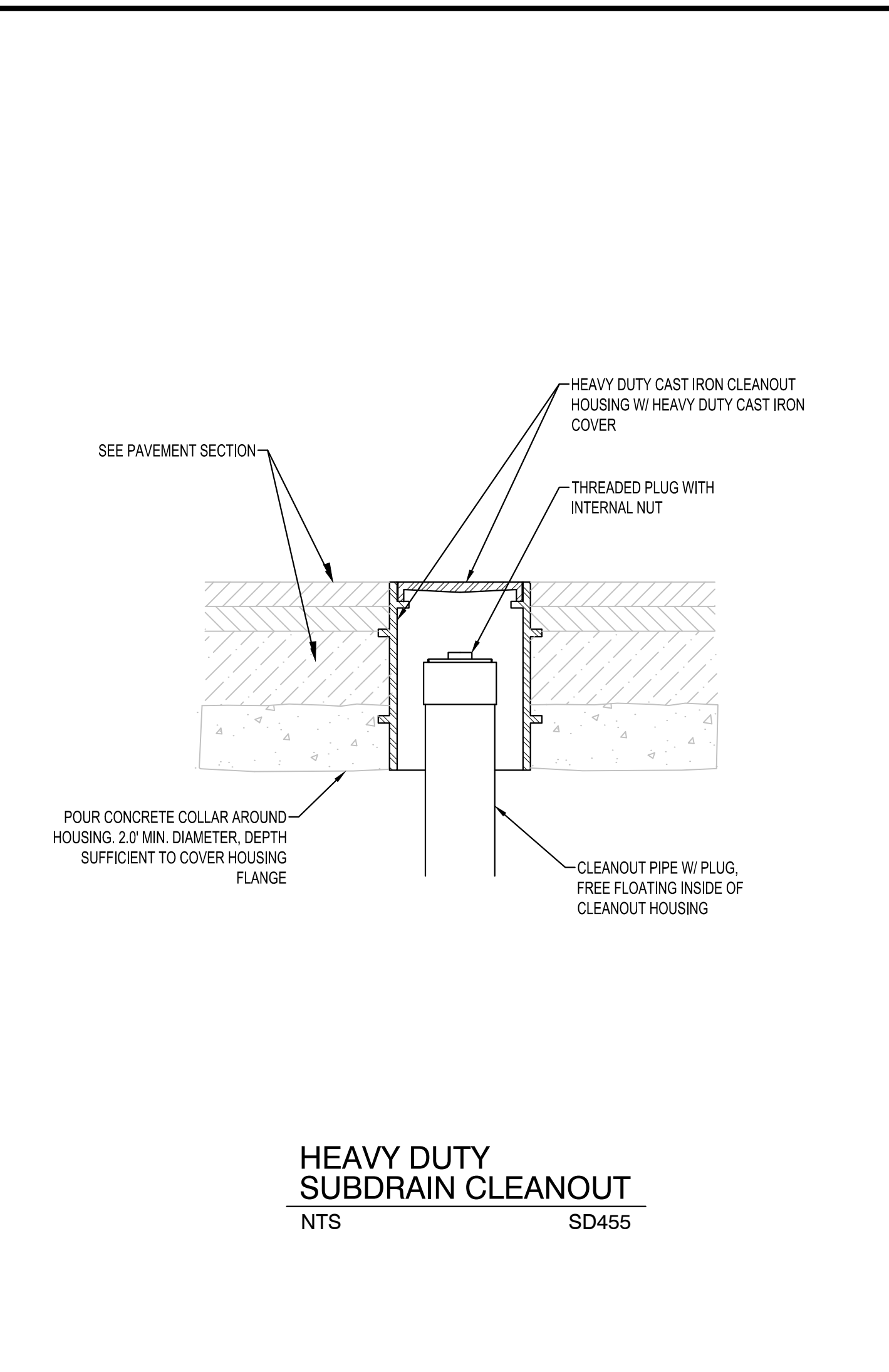
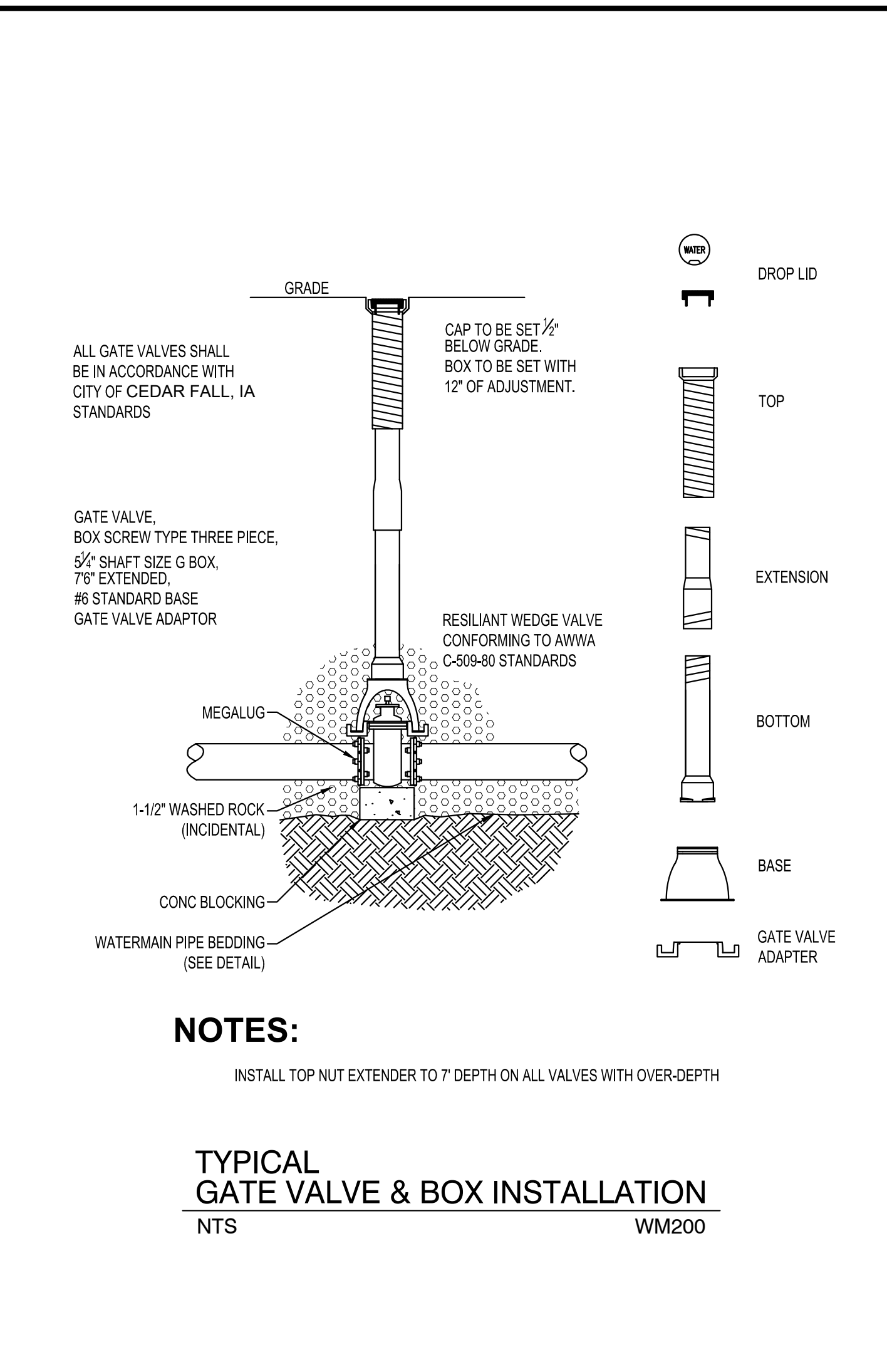
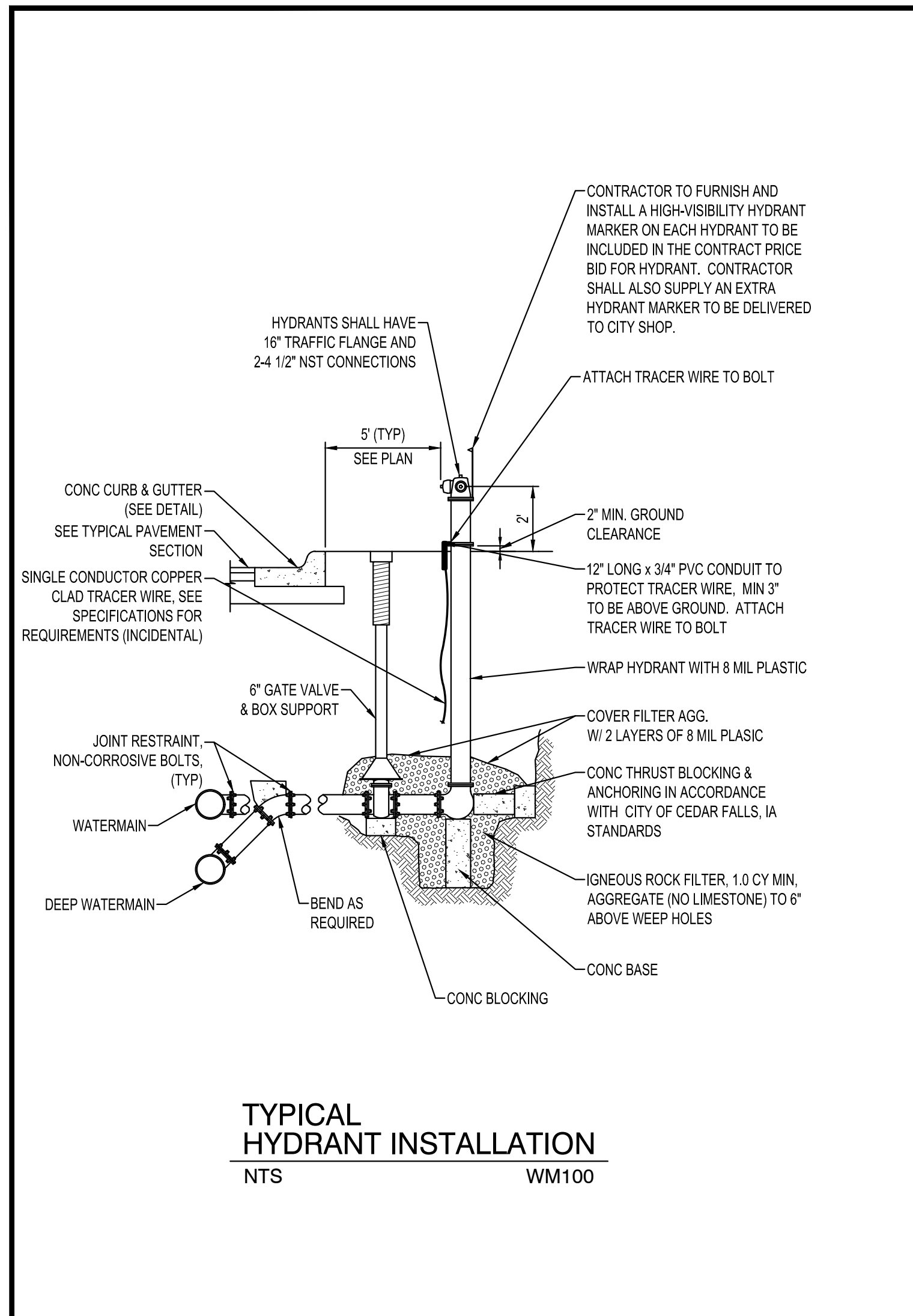

MANAGING LOCATION:
MINNEAPOLIS / ST. PAUL OFFICE
7900 INTERNATIONAL DRIVE
INTERNATIONAL PLAZA, SUITE 550
MINNEAPOLIS, MN 55425
PHONE: 952.426.0699

ALDI Inc.
4201 Bagley Avenue North
Faribault, MN 55021
(507) 333-7460
(507) 333-9475 Fax

ALDI Inc. Store #: 64
CEDAR FALLS, IA
219 BRANDILYNN BLVD
CEDAR FALLS, IA 50613
BLACKHAWK COUNTY
Project Name & Location:

SITE DETAILS

Drawing Name: ISG Project No.
Type: V7.0 ER 16-19997
Drawn By: JMF
Designed By: JMF C-022
Reviewed By: RJA Drawing No.

Issued:	Date:
A SITE PLAN SUBMITTAL	02/19/21
B PERMIT SET	03/19/21
C BID SET	04/05/21
D	
E	
Revisions:	Date:
1	
2	
3	
4	
5	
6	
7	
8	
9	

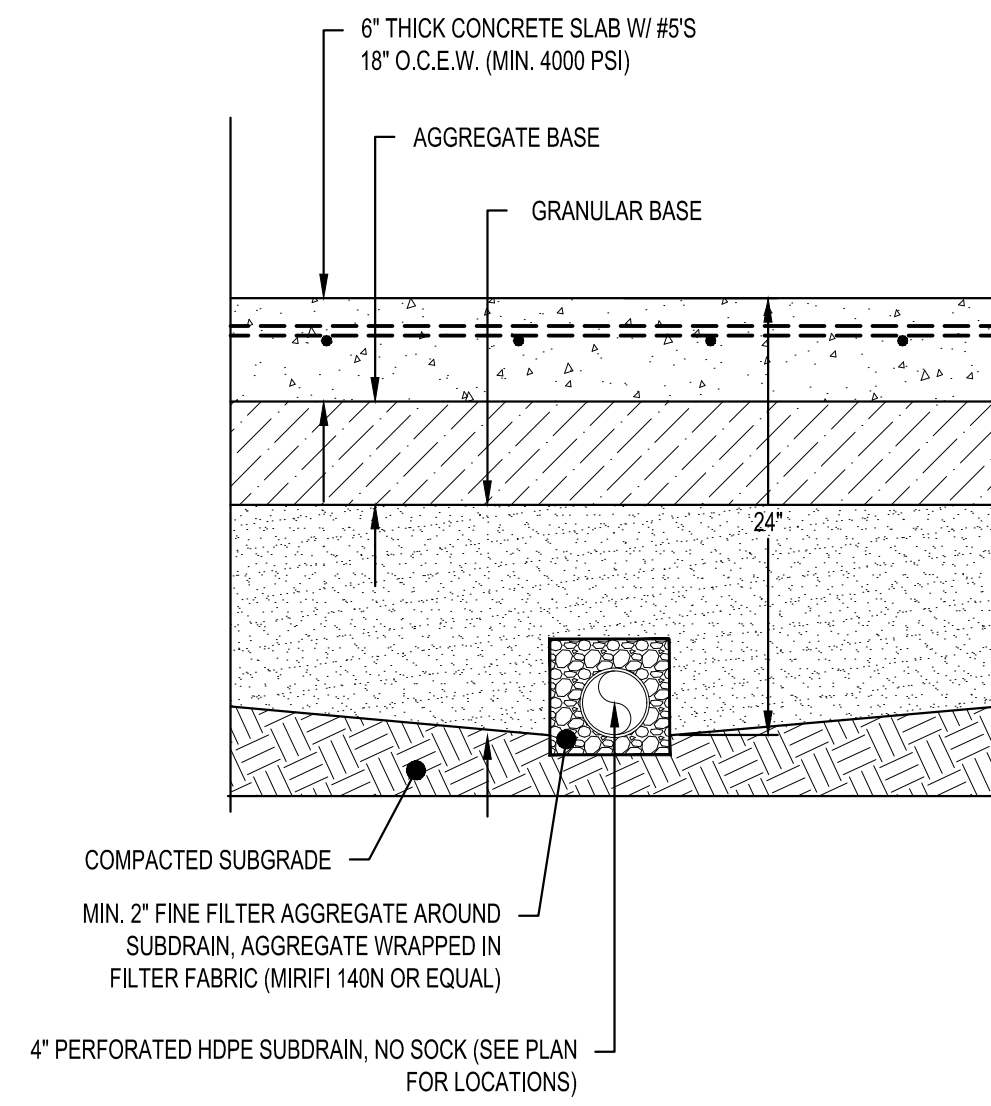

LOADING DOCK PAVEMENT SECTION

N.T.S.

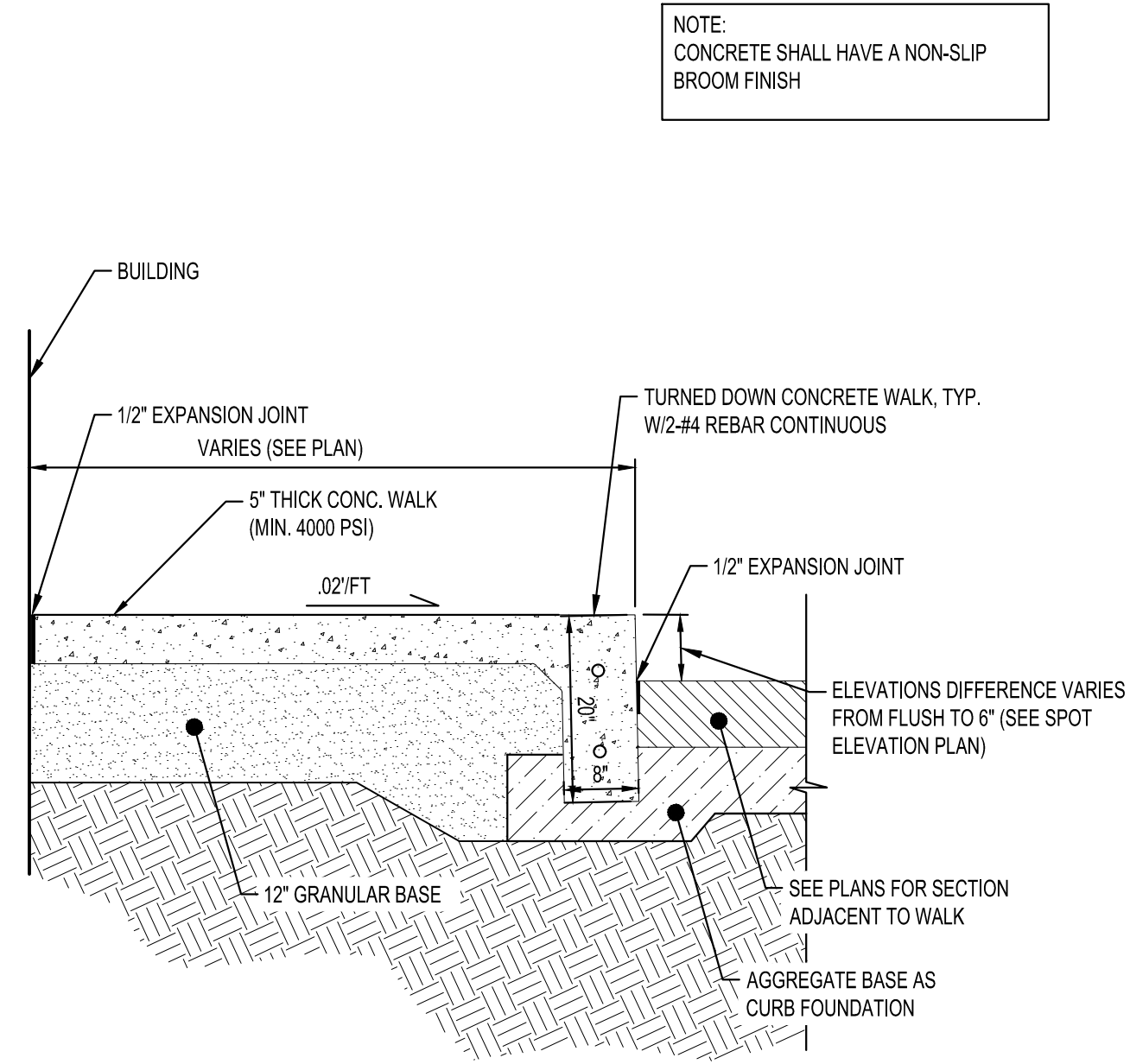

TURN DOWN CONCRETE WALK SECTION

N.T.S.

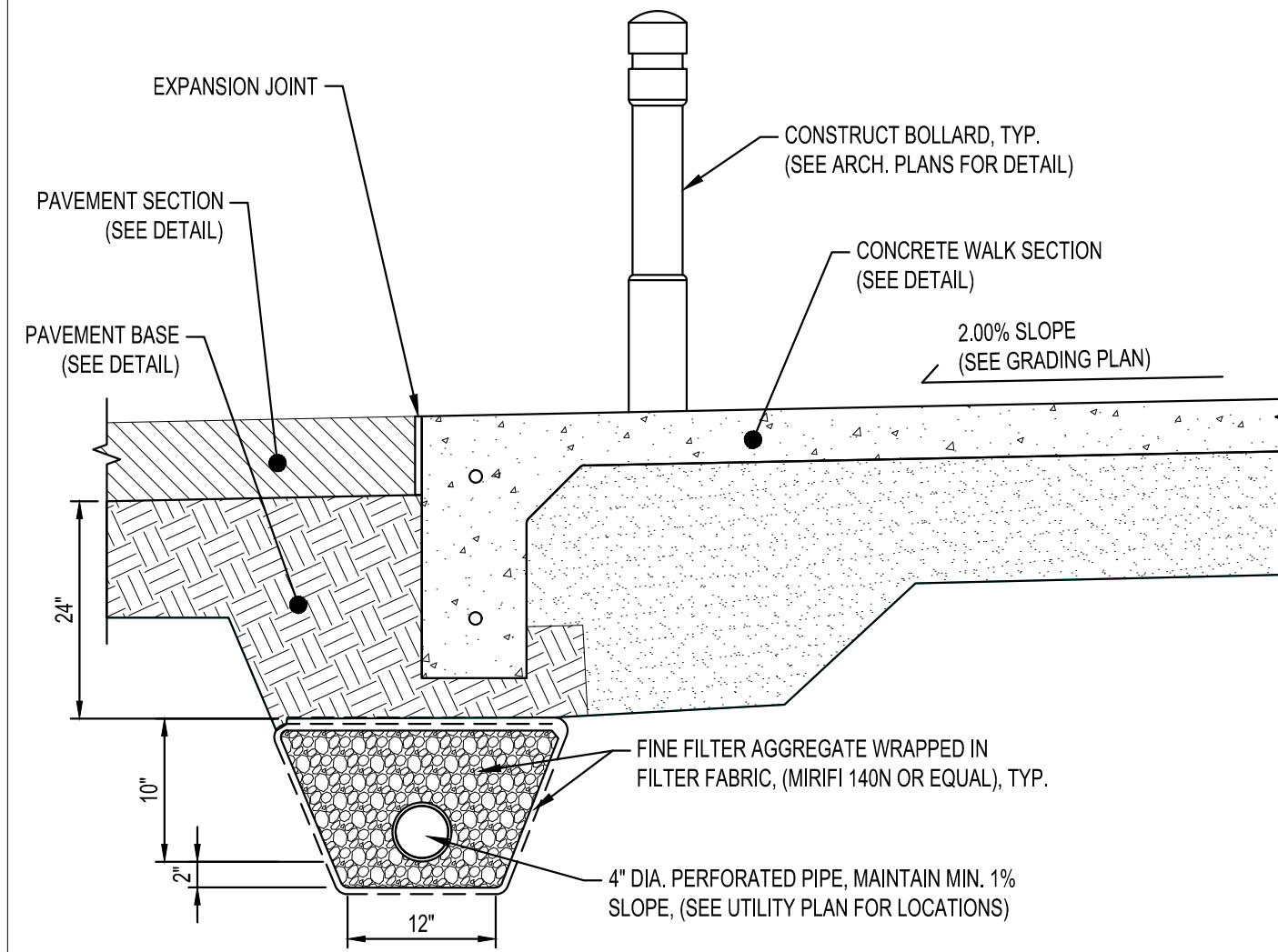

BUILDING SIDEWALK DRAIN TILE SECTION

N.T.S.

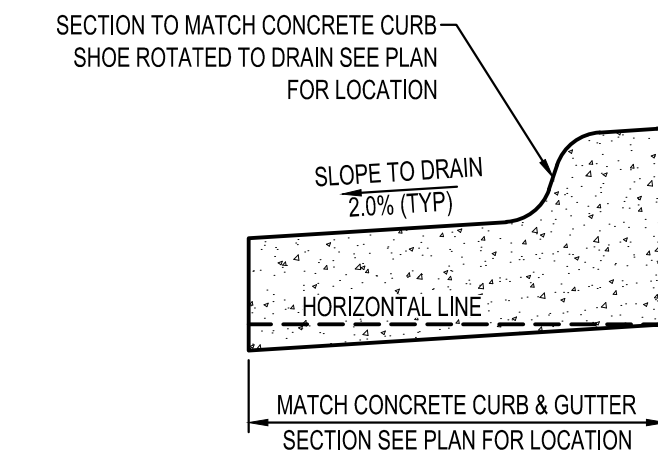

REVERSE PITCH CONCRETE CURB & GUTTER

NTS

ST250

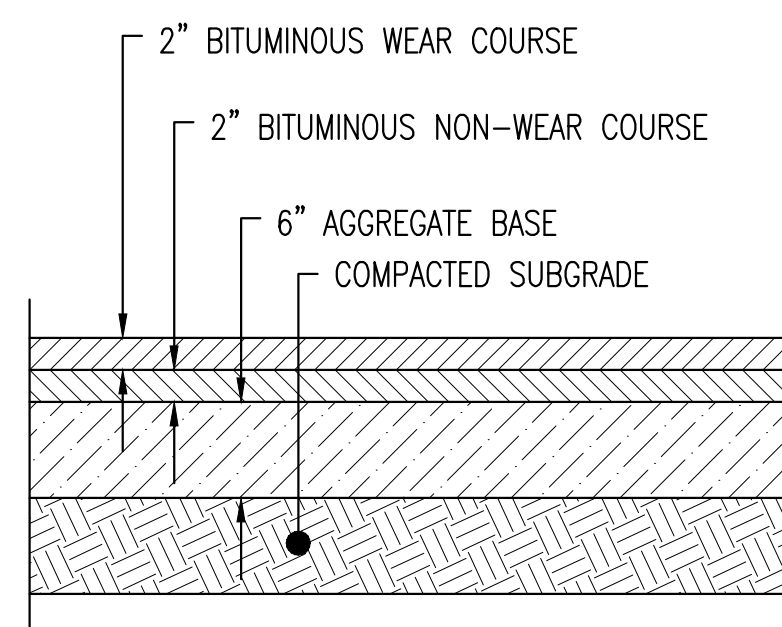

STANDARD BITUMINOUS PAVEMENT SECTION

N.T.S.

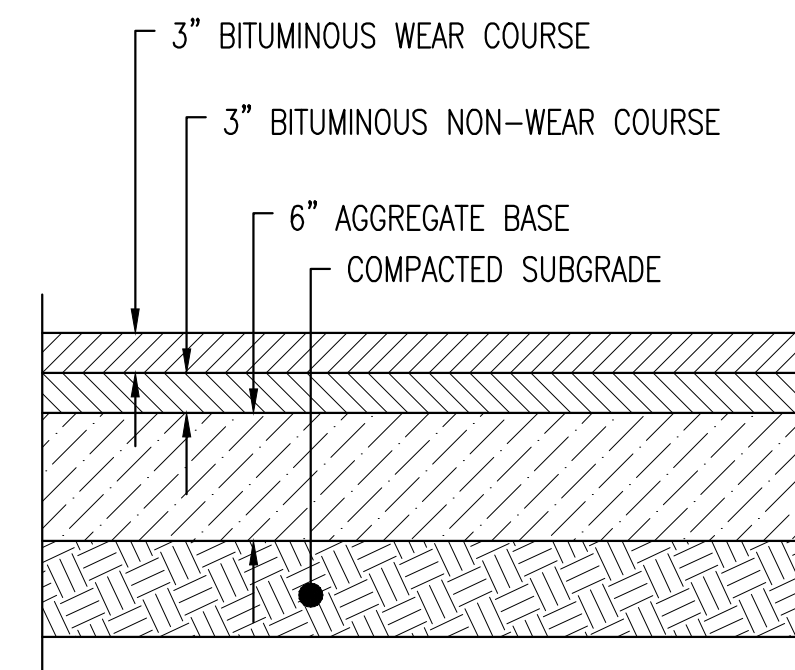

HEAVY DUTY BITUMINOUS PAVEMENT SECTION

N.T.S.

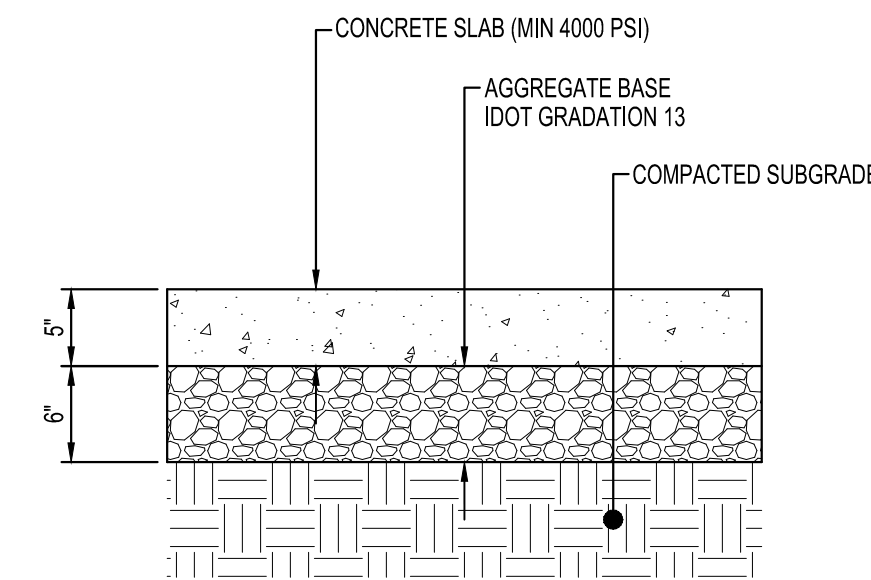

STANDARD CONCRETE PAVEMENT

NTS

ST120

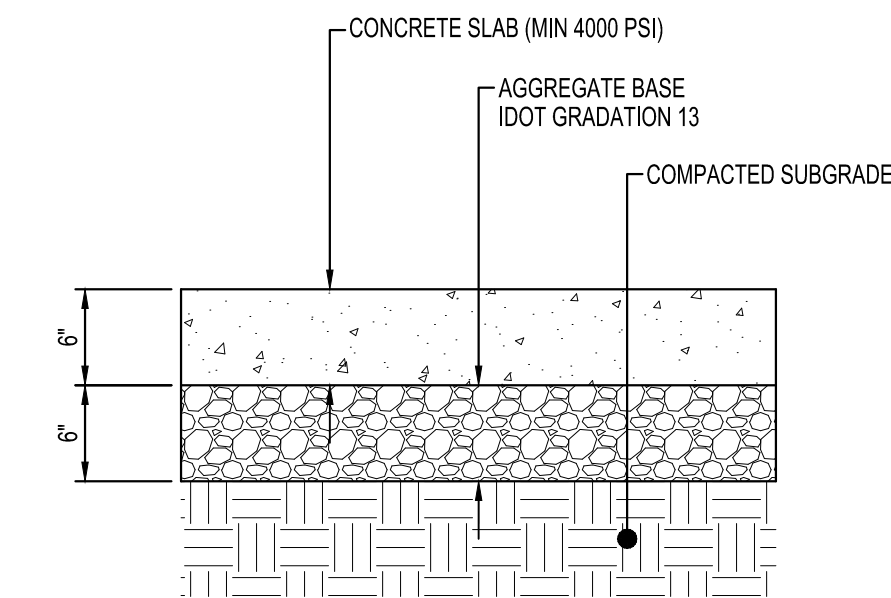

HEAVY DUTY CONCRETE PAVEMENT

NTS

ST125



MANAGING LOCATION:
MINNEAPOLIS / ST. PAUL OFFICE
 7900 INTERNATIONAL DRIVE
 INTERNATIONAL PLAZA, SUITE 550
 MINNEAPOLIS, MN 55425
 PHONE: 952.426.0699



ALDI Inc. Store #: 64
CEDAR FALLS, IA
 219 BRANDILYNN BLVD
 CEDAR FALLS, IA 50613
 BLACKHAWK COUNTY
 Project Name & Location:

SITE DETAILS

Drawing Name:

Type: V7.0 ER

Drawn By: JMF

Designed By: JMF

Reviewed By: RJA

ISG Project No.

16-19997

C-023

Drawing No.

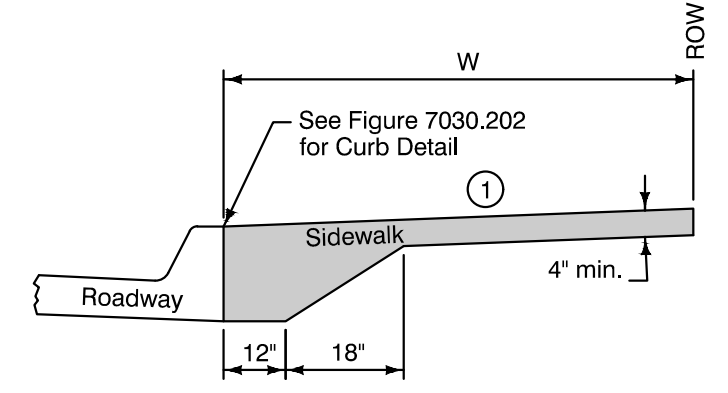

CLASS A SIDEWALK
(Sidewalk extends from back of curb to ROW)

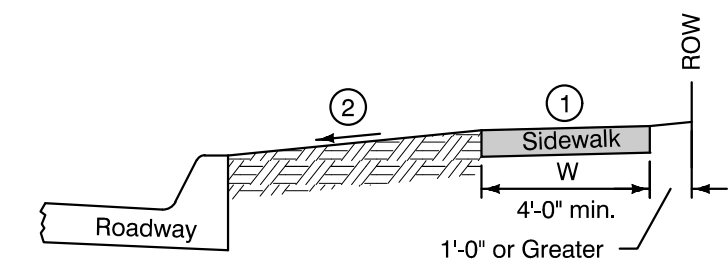

CLASS B SIDEWALK

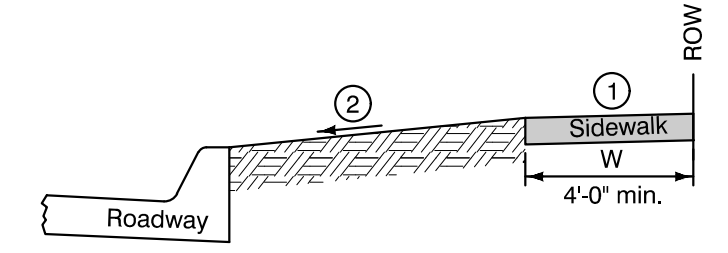

CLASS C SIDEWALK

- Target cross slope of 1.5% with a maximum cross slope of 2.0% (including sidewalk through driveway).
- Parking Slopes:
If parking width is less than 10 feet wide, slope at 1/4 inch per foot.
If parking width is 10 feet wide and greater, slope at 1/8 inch per foot.
Special grade may be specified in the contract documents.

W = Sidewalk width as specified in the contract documents.

	REVISION	NO. 1	DATE 10-20-15
	FIGURE	7030.201	SHEET 1 of 1
SUDAS Standard Specifications			
CLASSES OF SIDEWALKS			

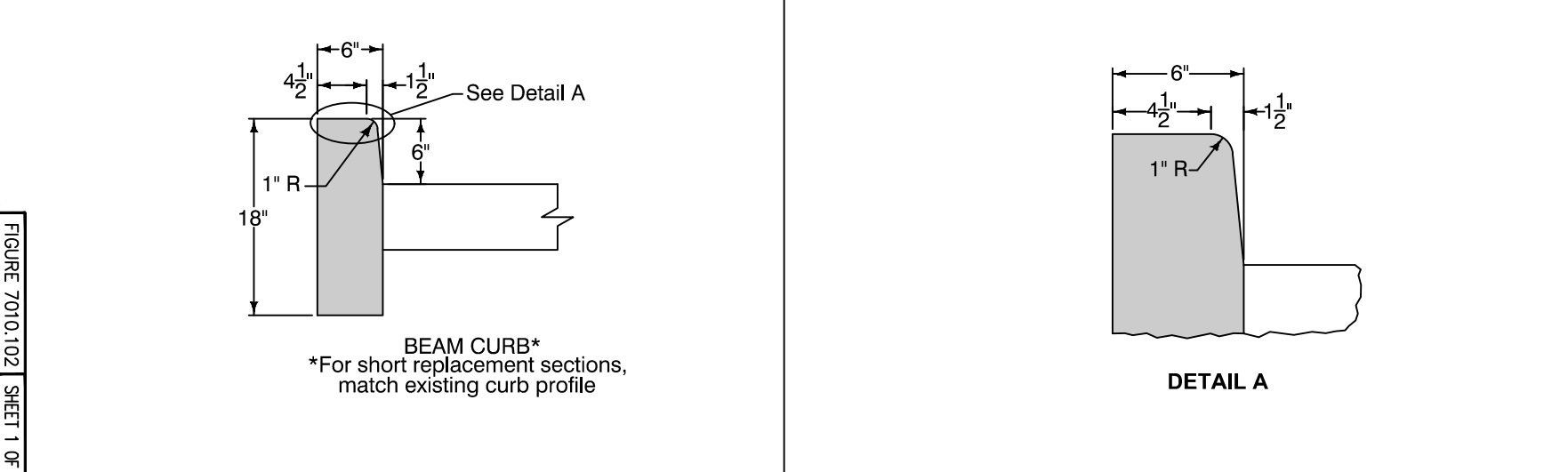
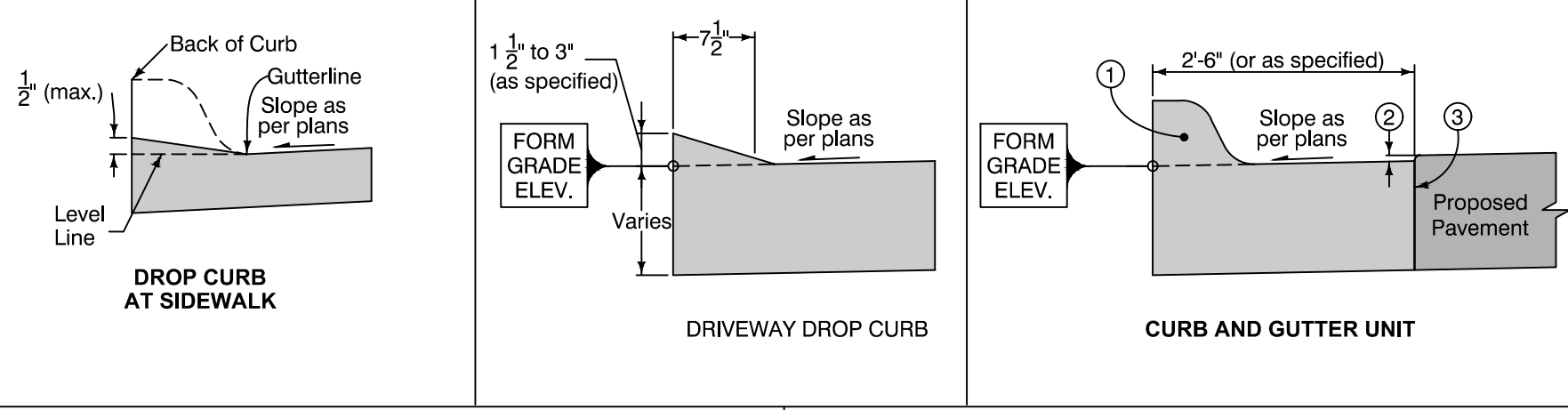
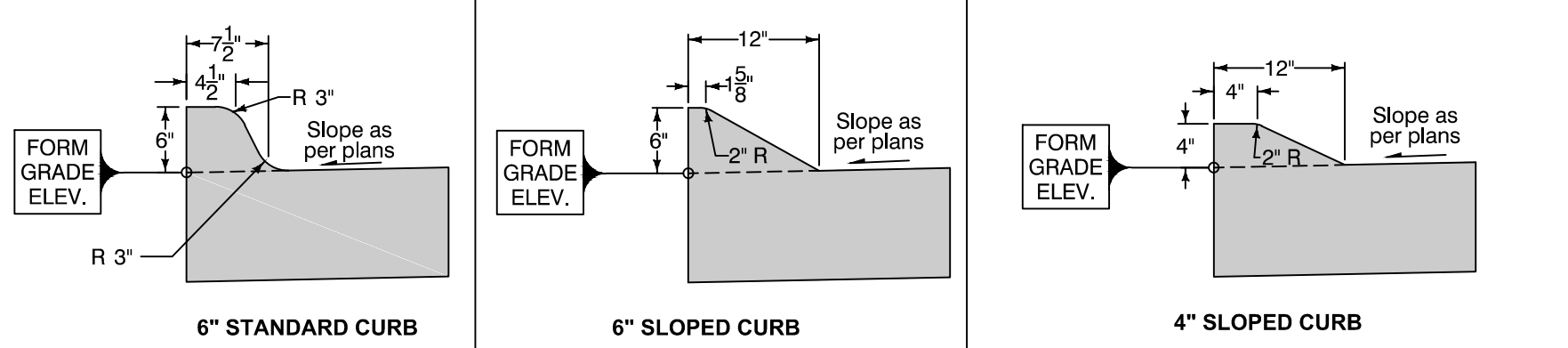

For joint details, see PV-101.

- 6" Standard Curb, 6" Sloped Curb, or 4" Sloped Curb as specified.
- 1/2" if Proposed Pavement is HMA. No elevation difference if Proposed Pavement is PCC.
- BT*, KT*, or L* joint if Proposed Pavement is PCC. BT* joint if Proposed Pavement is HMA.

	REVISION	NO. 4	DATE 10-18-15
	FIGURE	7010.002	SHEET 1 of 2
SUDAS Standard Specifications			
PCC CURB DETAILS			

FIGURE 7030.201 SHEET 1 OF 1

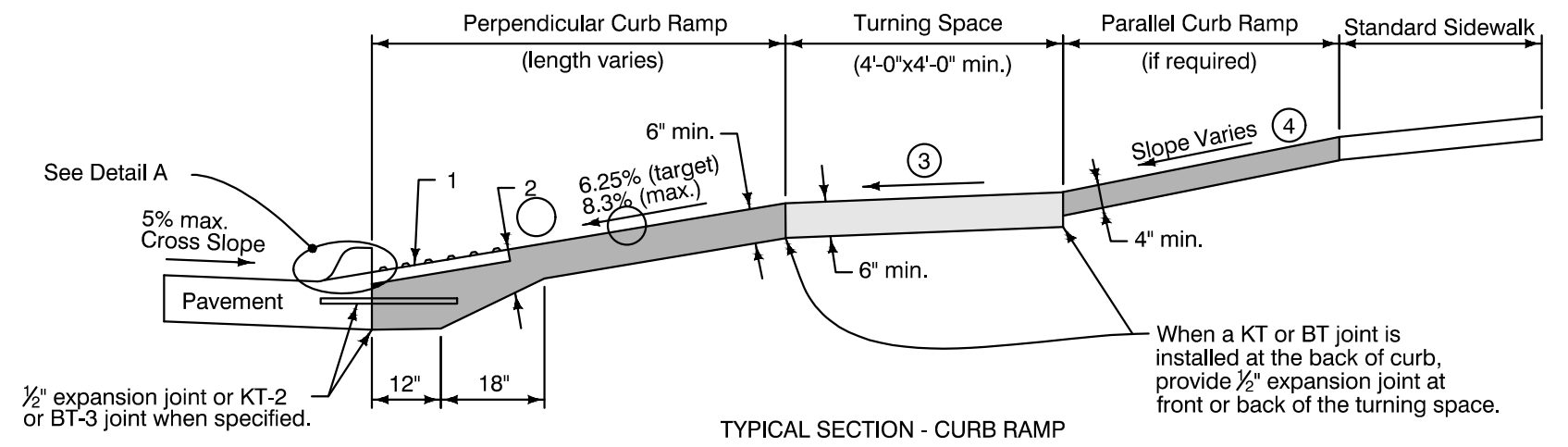

TYPICAL SECTION - CURB RAMP

- Key
- Curb Ramp
 - Turning Space
 - Detectable warning

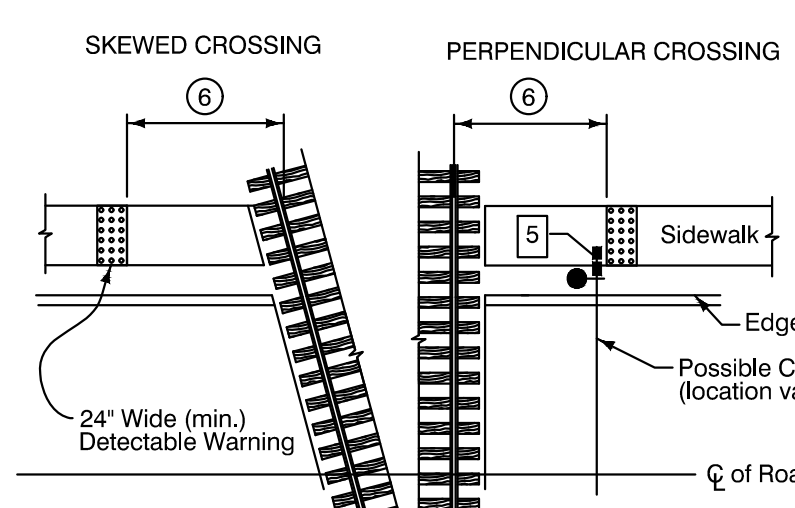

DETECTABLE WARNING LOCATION AT RAILROAD CROSSING

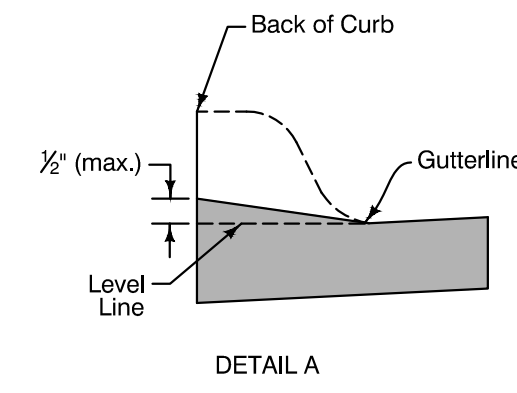

DETAIL A

- Provide a minimum 2 foot width of detectable warning surfaces in the direction of pedestrian travel across the full width of the curb ramp or turning space, exclusive of curbs or flares.
- Provide a minimum of 6 inches of concrete below the detectable warning panel.
- Minimum 4 feet by 4 feet. Target cross slope of 1.5% with a maximum cross slope of 2.0%.
- If normal sidewalk elevation cannot be achieved with the perpendicular ramp between the street and landing due to limited ramp length, provide a parallel ramp to make up the elevation difference between the landing and the standard sidewalk.

The length of the parallel ramp is not required to exceed 15 feet, regardless of the resulting slope. Do not exceed 8.3% slope for parallel ramps shorter than 15 feet.
- If crossing gate conflicts with location of detectable warning or if pedestrian crossing gate is provided, place detectable warning panel in advance of the crossing gate.
- Locate front edge of detectable warning panel 12 to 15 feet from centerline of nearest rail. Orient truncated domes parallel to the direction of pedestrian travel.

	REVISION	NO. 1	DATE 10-20-15
	FIGURE	9040.110	SHEET 1 of 1
SUDAS Standard Specifications			
GENERAL SIDEWALK AND CURB RAMP DETAILS			

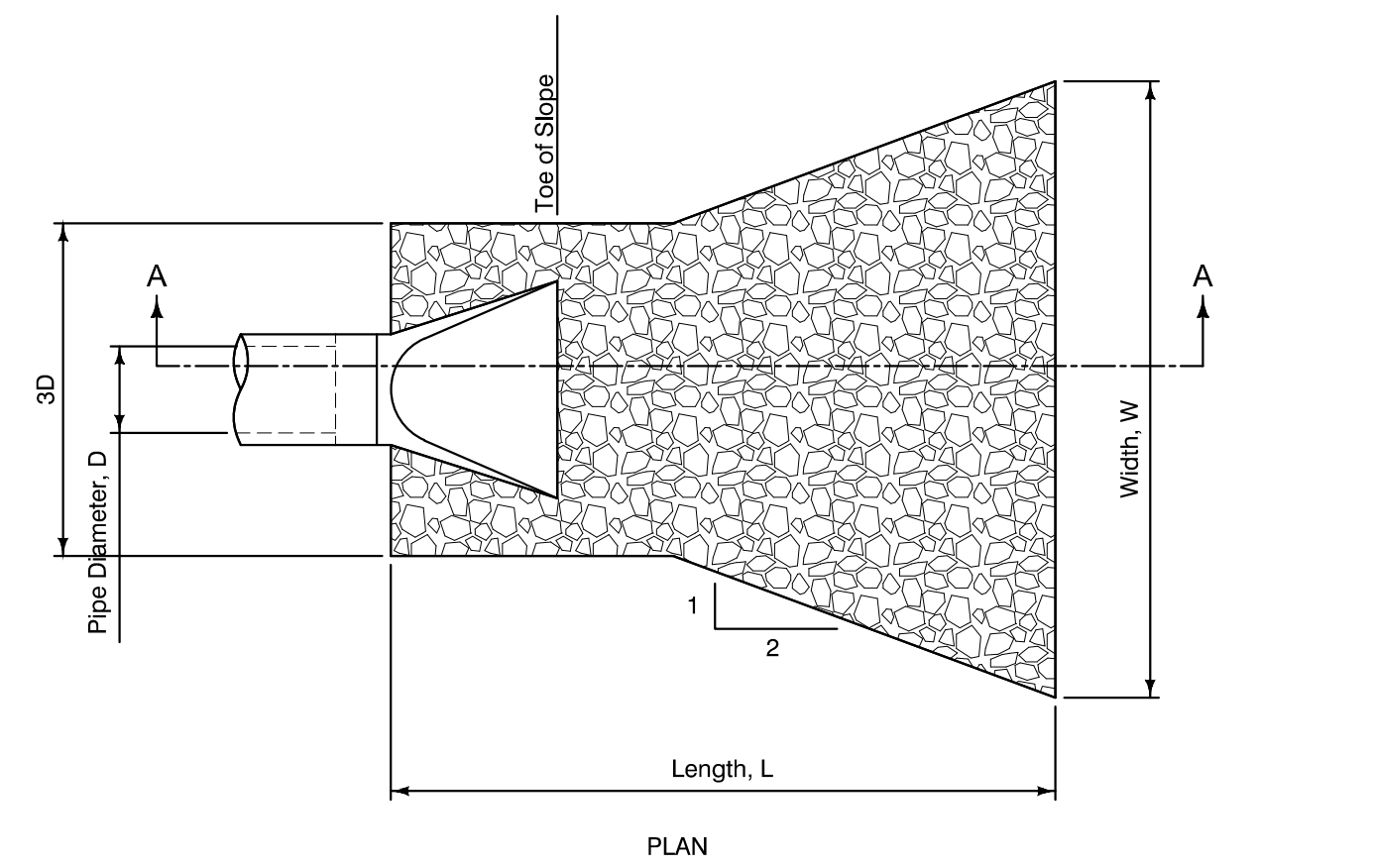

PLAN

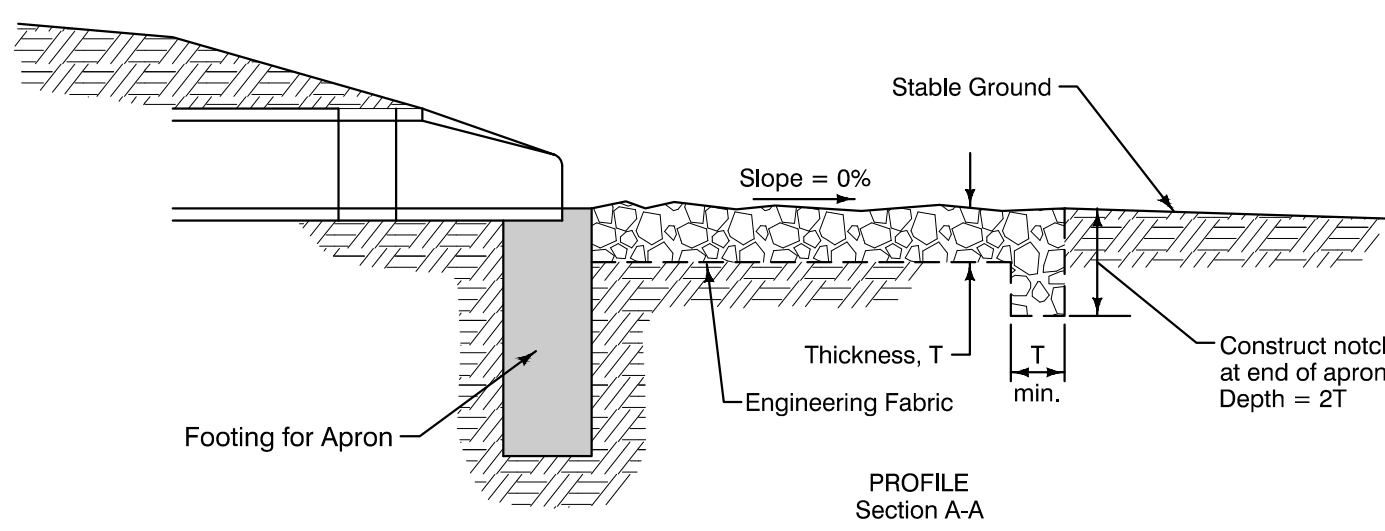

PROFILE Section A-A

	REVISION	NO. 3	DATE 10-21-14
	FIGURE	9040.110	SHEET 1 of 1
SUDAS Standard Specifications			
RIP RAP FOR PIPE OUTLET ONTO FLAT GROUND			

FIGURE 7030.204 SHEET 1 OF 1

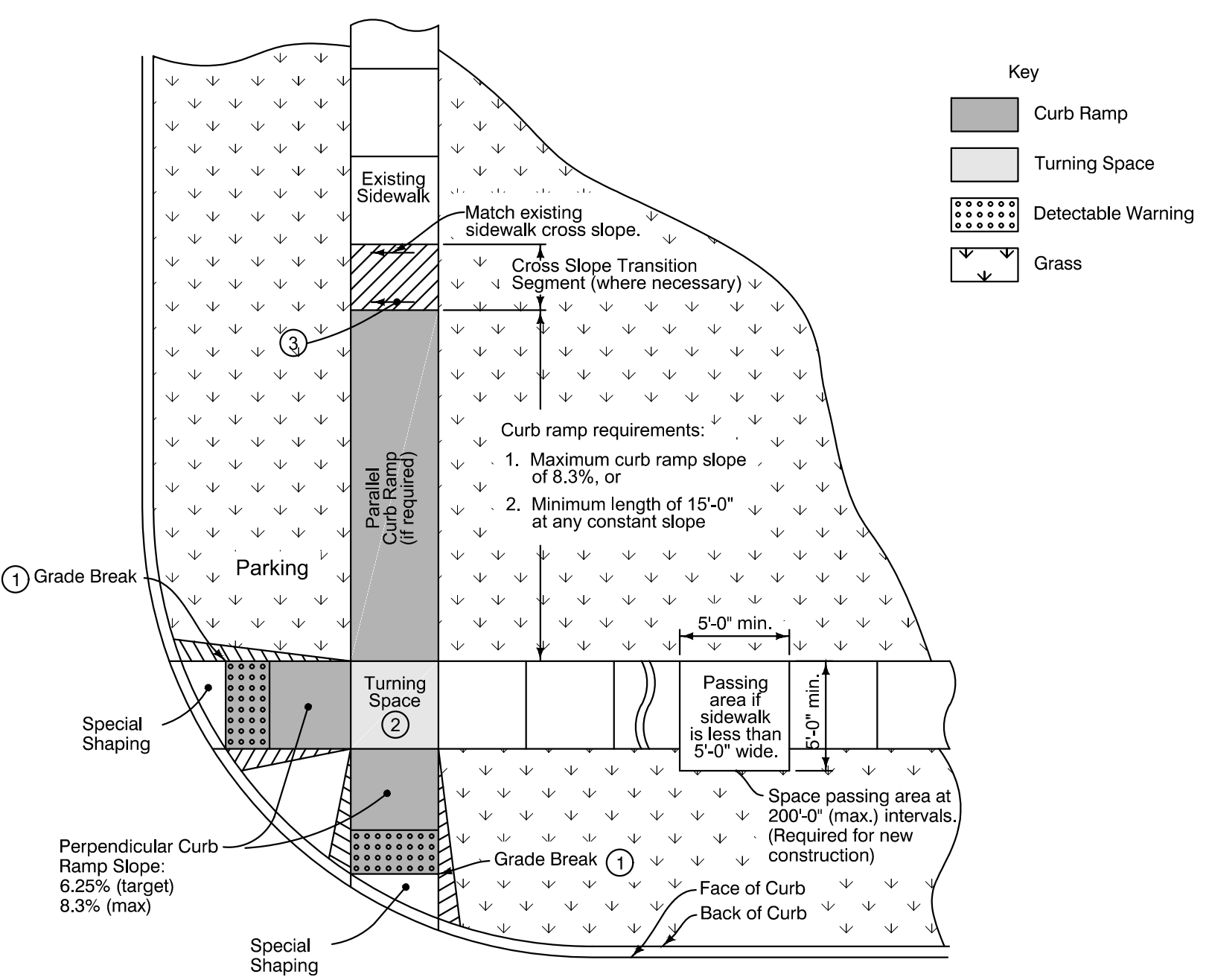

- Match pedestrian street crossing slope, or flatter.
- Minimum 4 feet by 4 feet. Target cross slope of 1.5% with a maximum cross slope of 2.0%.
- Target cross slope of 1.5% with a maximum cross slope of 2.0%.

	REVISION	NO. 3	DATE 10-20-15
	FIGURE	7030.204	SHEET 1 of 1
SUDAS Standard Specifications			
GENERAL FEATURES OF AN ACCESSIBLE SIDEWALK			

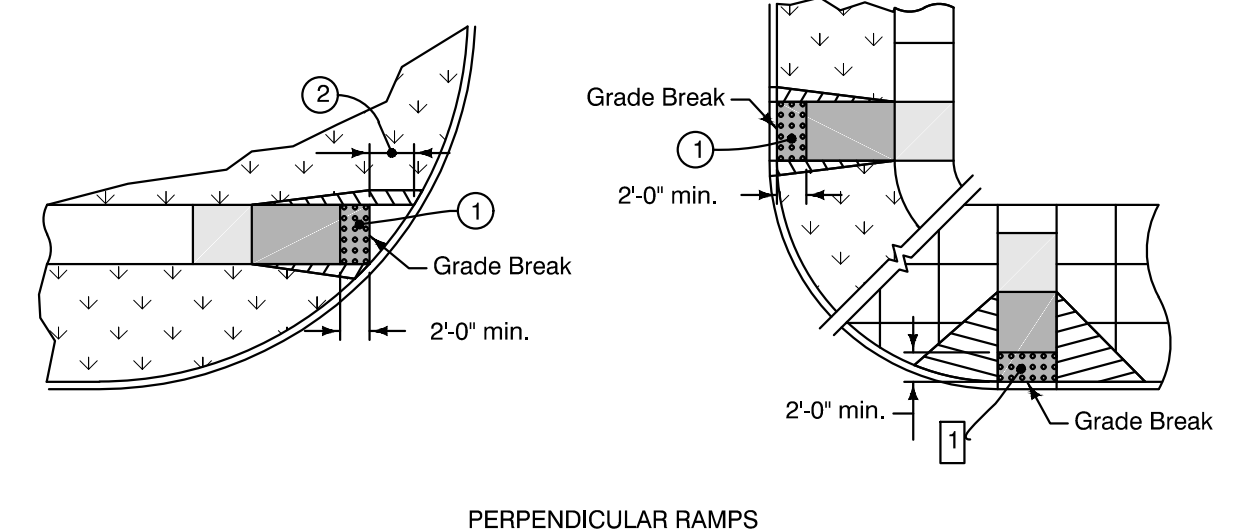

PERPENDICULAR RAMPS

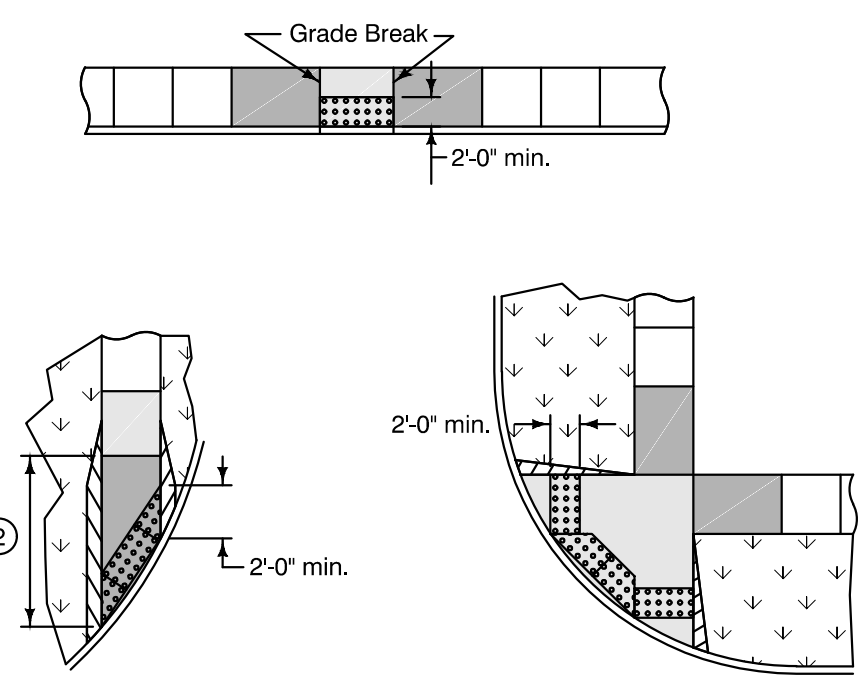

PARALLEL RAMPS

- Provide a minimum 2 foot width of detectable warning surfaces in the direction of pedestrian travel across the full width of the curb ramp or turning space, exclusive of curbs or flares.
- When detectable warning is located on curb ramp surface, orient domes in the direction of pedestrian travel.
 - When the distance between the grade break and the back of curb is less than 5 feet, place detectable warning surface at the bottom of the curb ramp.

Where one corner of the curb ramp is more than 5 feet from the back of curb, construct curb ramp as a parallel curb ramp. Move grade break back as required to place detectable warning on turning space at the back of curb.

- Key
- Curb Ramp
 - Turning Space
 - Detectable Warning

	REVISION	NO. 3	DATE 10-16-12
	FIGURE	7030.210	SHEET 1 of 1
SUDAS Standard Specifications			
DETECTABLE WARNING PLACEMENT			

Issued:	Date:
A SITE PLAN SUBMITTAL	02/19/21
B PERMIT SET	03/19/21
C BID SET	04/05/21
D	
E	
Revisions:	Date:
1	
2	
3	
4	
5	
6	
7	
8	
9	



MANAGING LOCATION:
MINNEAPOLIS / ST. PAUL OFFICE
 7900 INTERNATIONAL DRIVE
 INTERNATIONAL PLAZA, SUITE 550
 MINNEAPOLIS, MN 55425
 PHONE: 952.426.0699



ALDI Inc. Store #: 64
CEDAR FALLS, IA
 219 BRANDILYNN BLVD
 CEDAR FALLS, IA 50613
 BLACKHAWK COUNTY
 Project Name & Location:

SITE DETAILS	
Drawing Name:	ISG Project No.
Type: V7.0 ER	16-19997
Drawn By: JMF	C-024
Designed By: JMF	
Reviewed By: RJA	Drawing No.

Issued:	Date:
A	SITE PLAN SUBMITTAL 02/19/21
B	PERMIT SET 03/19/21
C	BID SET 04/05/21
D	
E	

Revisions:	Date:
1	
2	
3	
4	
5	
6	
7	
8	
9	

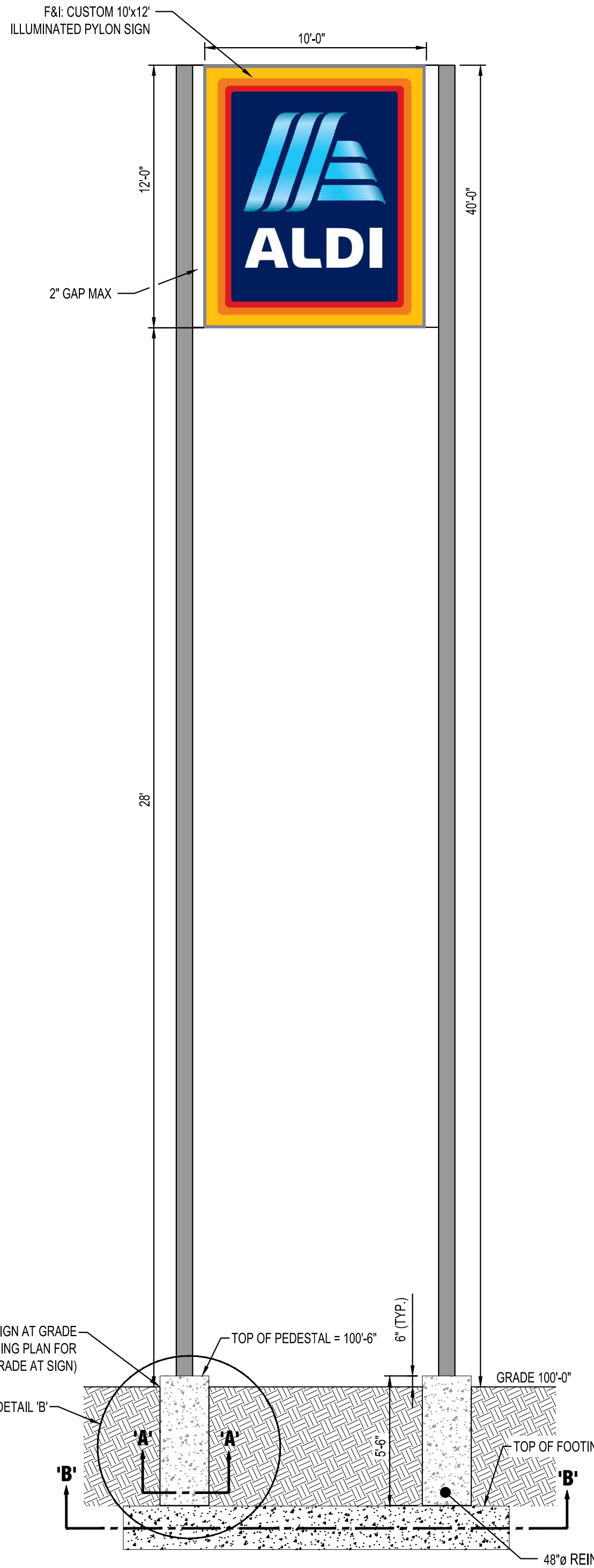

ALDI, INC. PYLON SIGN DETAIL 'A'

N.T.S.

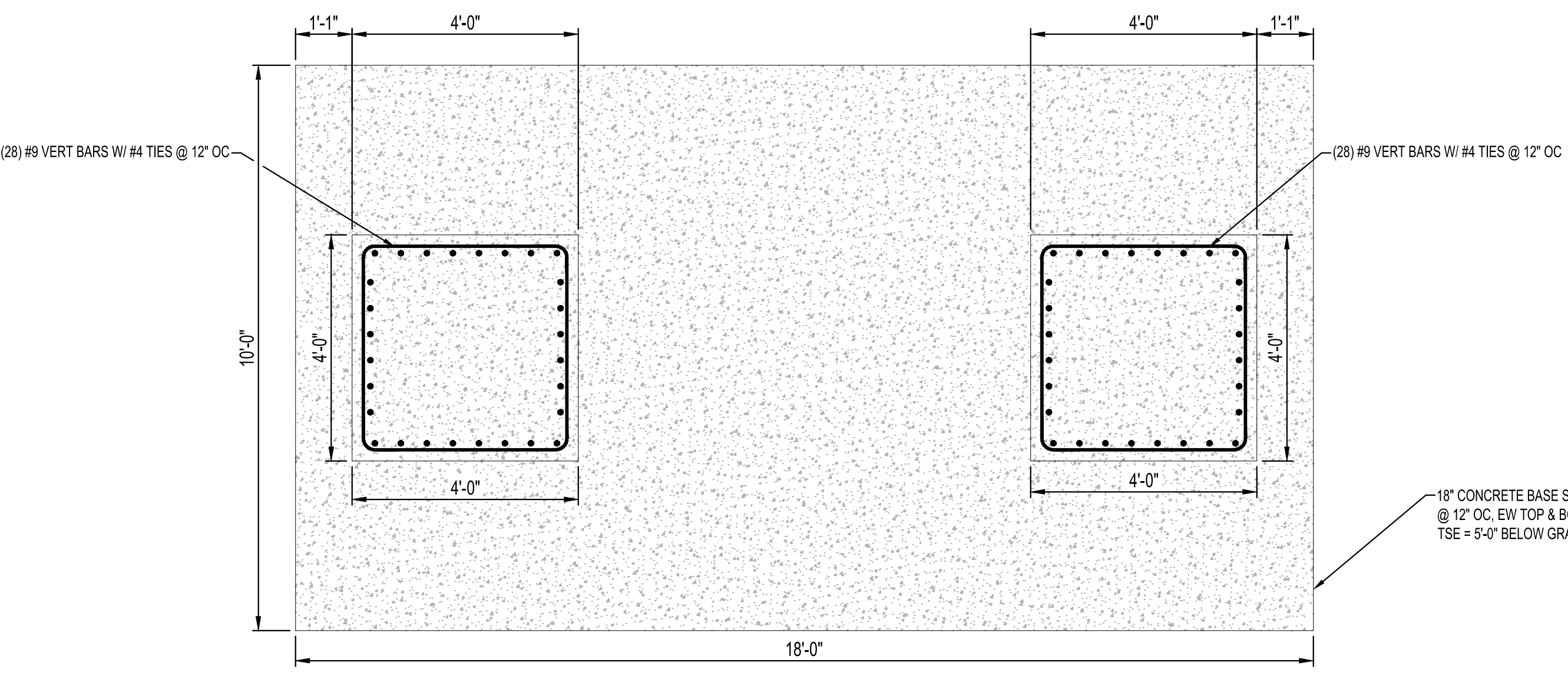

'B'-'B'

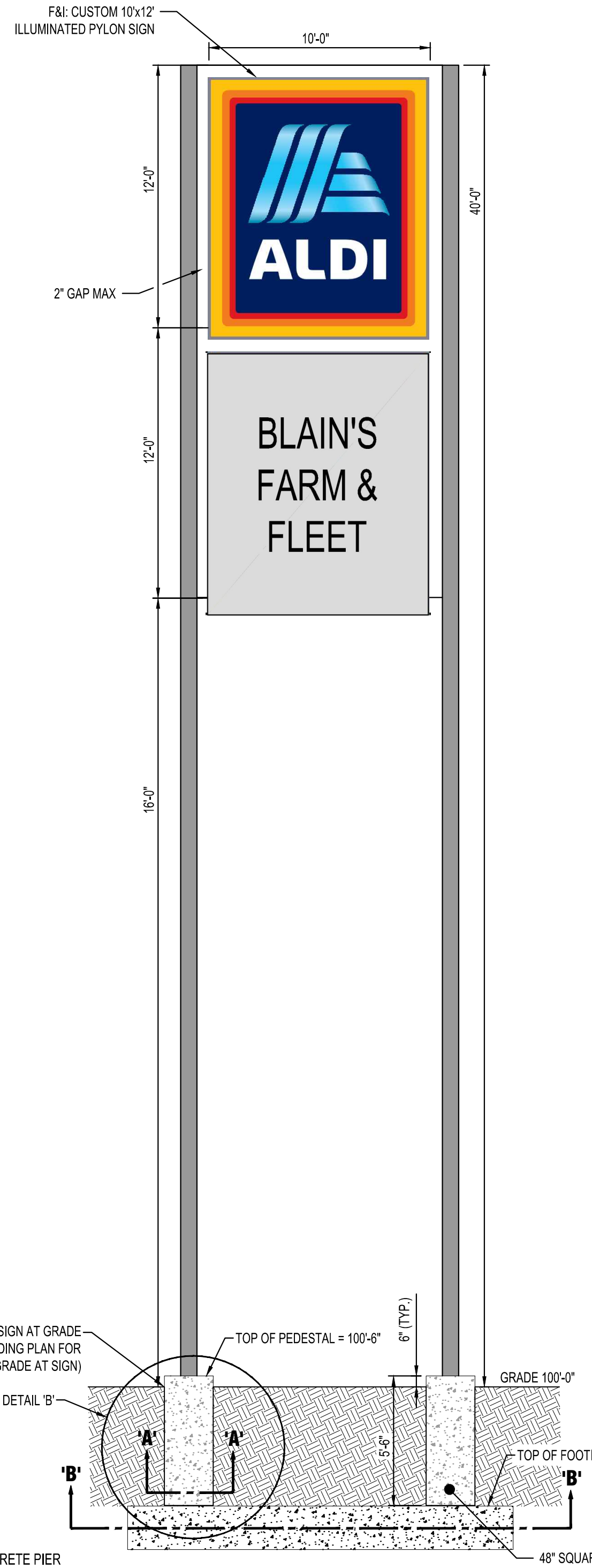

ALDI, INC. PYLON SIGN DETAIL 'B'

N.T.S.

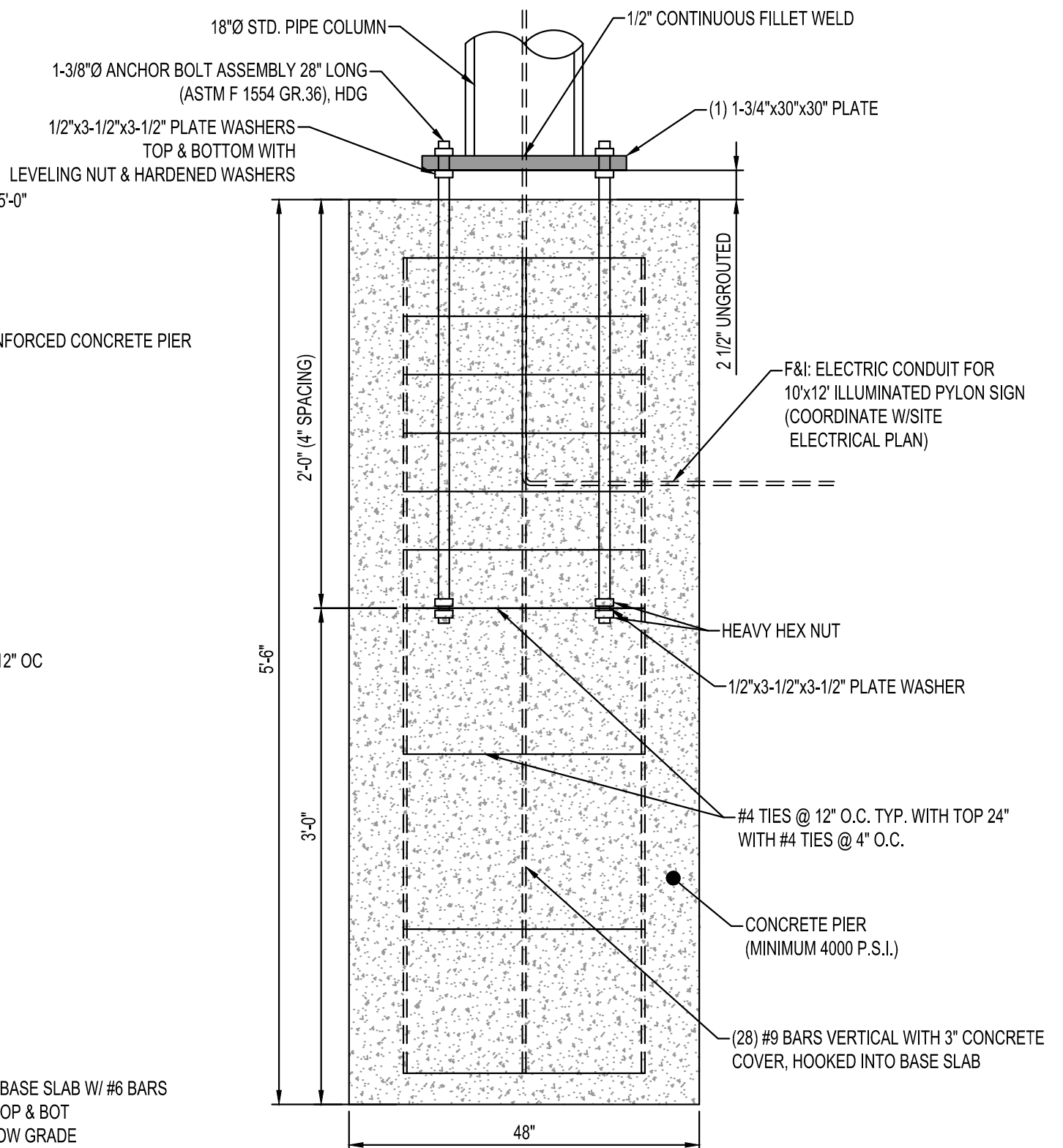

DETAIL 'B'

N.T.S.

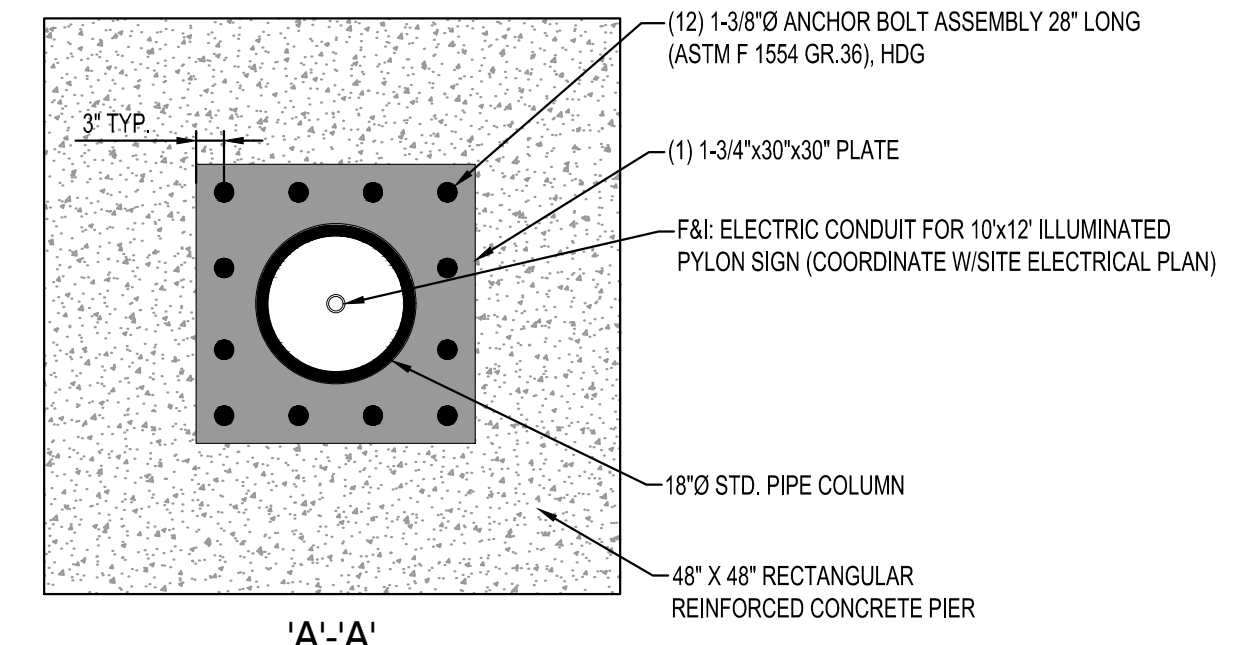

'A'-'A'

CONSTRUCTION NOTES:

A. SPECIFICATIONS

- DESIGN, FABRICATION, AND ERECTION OF STRUCTURAL STEEL SHALL BE IN ACCORDANCE WITH THE "STEEL CONSTRUCTION MANUAL", 14TH EDITION, BY THE AMERICAN INSTITUTE OF STEEL CONSTRUCTION, UNO.
- STEEL MATERIALS SHALL MEET THE REQUIREMENTS OF THE FOLLOWING SPECIFICATIONS, UNO.
 - HSS RECTANGULAR, ASTM A500 GRADE B, Fy = 46 ksi
 - HSS ROUND, ASTM A500 GRADE B, Fy = 42 ksi
 - PIPE, ASTM A53 GRADE B, Fy = 35 ksi
 - PLATES AND BARS, ASTM A36, Fy = 36 ksi
- ALL WELDING SHALL CONFORM TO THE REQUIREMENTS OF AWS D1.1 (LATEST EDITION) "STRUCTURAL WELDING CODE".
- CONCRETE SHALL BE NORMAL WEIGHT, UNO, AND MEET THE FOLLOWING CRITERIA.
 - f_c = 4,000 psi
 - 6% +/- 1.5% AIR ENTRAINMENT
 - 0.55 MAXIMUM WATER-TO-CEMENT RATIO
 - CEMENT SHALL CONFORM TO ASTM C150, TYPE III
 - READY-MIX CONCRETE SHALL BE MIXED AND DELIVERED ACCORDANCE WITH ASTM C94.
 - CONCRETE SHALL BE CAST IN PLACE AGAINST UNDISTURBED SOIL. A SONO-TUBE FORM SHOULD ONLY BE USED FOR THE TOP 12" OF THE FOOTING. CONCRETE FORM-WORK SHALL CONFORM TO ALL REQUIREMENTS OF ACE 301 (LATEST EDITION) "SPECIFICATIONS FOR STRUCTURAL CONCRETE FOR BUILDINGS", EXCEPT AS MODIFIED BY THESE DRAWINGS.
- ALL ANCHOR RODS SHALL BE SUPPLIED AND INSTALLED BY THE CONCRETE CONTRACTOR, UNO, AND MEET THE FOLLOWING SPECIFICATIONS.
 - ALL ANCHOR RODS SHALL BE ASTM F1554, GRADE 36, HEX-HEAD, NUTS SHALL BE ASTM A563, GRADE A, HEAVY-HEX, HARDENED WASHERS SHALL BE ASTM 436, OVER-SIZED PLATE WASHERS SHALL BE ASTM A36, AND ALL HOT-DIPPED GALVANIZED.
 - ALL ANCHOR RODS SHALL BE SET WITH TEMPLATES.
- DEFORMED BAR REINFORCEMENT SHALL BE ASTM A615, GRADE 60, UNO, AND MEET THE FOLLOWING CRITERIA.
 - DEVELOPMENT LENGTH OF STRAIGHT BARS SHALL BE 48 TIMES THE DIAMETER OF THE BAR.
 - MINIMUM CLEAR CONCRETE COVER SHALL BE 3 INCHES.
 - ALL REINFORCING STEEL, ANCHOR RODS, DOWELS, AND INSERTS SHALL BE SECURED IN POSITION WITH WIRE POSITIONERS, OR EQUIVALENT, BEFORE PLACING CONCRETE.
- CONCRETE POLES ARE TO BE PAINTED "SHERWIN WILLIAMS SW-7019 GAUNTLET GRAY". FOLLOW MANUFACTURER'S SPEC FOR PAINTING.

B. SUBMITTALS:

- PRIOR TO SUBMITTAL, THE CONTRACTOR SHALL REVIEW THE SHOP DRAWINGS AND MAKE ANY CORRECTIONS REQUIRED. THE CONTRACTOR SHALL STAMP AND SIGN THE SHOP DRAWINGS PRIOR TO SUBMITTAL TO THE ENGINEER.
- THE CONTRACTOR SHALL SUBMIT PRODUCT DATA FOR PROPRIETARY MATERIAL AND ITEMS, INCLUDING FORMING ACCESSORIES, ADMIXTURES, PATCHING COMPOUNDS, SEALANTS, WATERSTOPS, JOINT SYSTEMS, CURING COMPOUNDS, AND OTHERS IN AND FOR CONSTRUCTION.
- THE FABRICATOR SHALL CLEARLY HIGHLIGHT/CLOUD ANY CHANGES MADE IN THE SHOP DRAWINGS WHICH DO NOT COMPLY WITH DESIGN DRAWINGS, ANY CHANGES MUST BE APPROVED BY THE ENGINEER PRIOR TO FABRICATION.
- CONTRACTOR TO SUBMIT THE FOLLOWING DRAWINGS TO ENGINEER FOR REVIEW PRIOR TO CONSTRUCTION OF SIGN.
 - CONCRETE REINFORCING STEEL
 - ANCHOR RODS
 - CONCRETE MIX DESIGNS
 - STRUCTURAL STEEL
 - ADDITIONAL SHOP DRAWINGS REQUESTED IN THE SPECIFICATIONS.
- A COPY OF ALL SHOP DRAWINGS SHALL BE MAINTAINED ON SITE AT ALL TIMES.

C. QUALITY CONTROL AND QUALITY ASSURANCE:

- COORDINATE FOR ENGINEER OR OWNER'S INDEPENDENT TESTING AGENCY TO INSPECT AND APPROVE REINFORCING STEEL AND EMBEDS PRIOR TO ORDERING CONCRETE.
- COORDINATE FOR OWNER'S INDEPENDENT TESTING AGENCY TO BE ON SITE AND PERFORM CONTINUOUS INSPECTION WHILE CONCRETE PLACEMENT IS OCCURRING. PROVIDE NOTICE NO LESS THAN 48 HOURS IN ADVANCE OF CONCRETE PLACEMENT.
- COORDINATE WITH OWNER'S INDEPENDENT TESTING AGENCY TO SAMPLE CONCRETE AT TIME OF PLACEMENT IN ORDER TO PERFORM SLUMP, AIR, TEMPERATURE AND CASTING OF CYLINDERS.
- ANY AND ALL WORK PERFORMED WITHOUT PROPER INSPECTION AND TESTING AS OUTLINED IN THIS SPECIFICATION WILL BE CONSIDERED UNAUTHORIZED WORK. ANY CORRECTIVE MEASURES REQUIRED OF THE UNAUTHORIZED WORK WILL BE AT CONTRACTORS OWN EXPENSE.



MANAGING LOCATION:
MINNEAPOLIS / ST. PAUL OFFICE
 7900 INTERNATIONAL DRIVE
 INTERNATIONAL PLAZA, SUITE 550
 MINNEAPOLIS, MN 55425
 PHONE: 952.426.0699

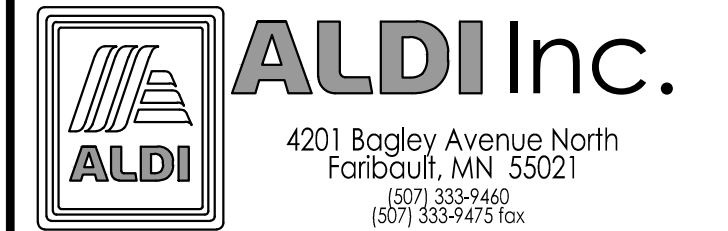

ALDI Inc. Store #: 64
 CEDAR FALLS, IA
 219 BRANDILYNN BLVD
 CEDAR FALLS, IA 50613
 BLACKHAWK COUNTY
 Project Name & Location:

PYLON SIGN DETAILS

Drawing Name:	ISG Project No.
Type: V7.0 ER	16-19997
Drawn By: JMF	
Designed By: JMF	C-025
Reviewed By: RJA	Drawing No.

Issued:		Date:
A	SITE PLAN SUBMITTAL	02/19/21
B	PERMIT SET	03/19/21
C	BID SET	04/05/21
D		
E		
Revisions:		Date:
1		
2		
3		
4		
5		
6		
7		
8		
9		

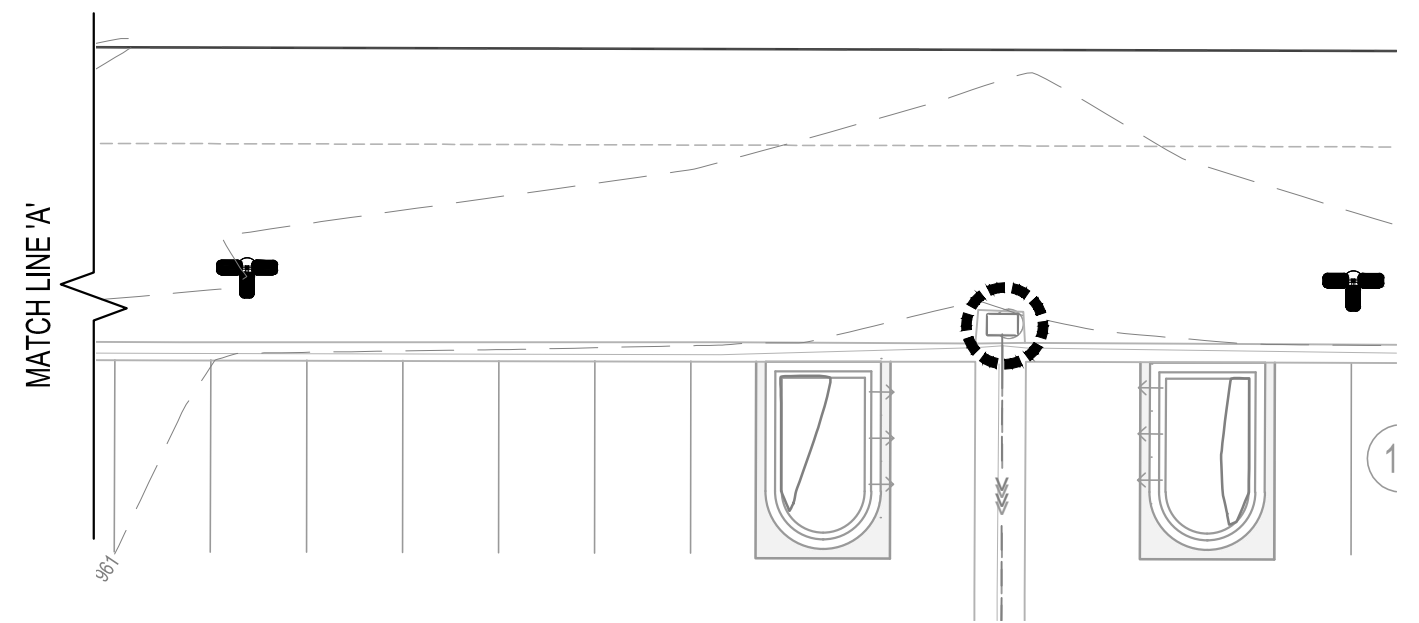
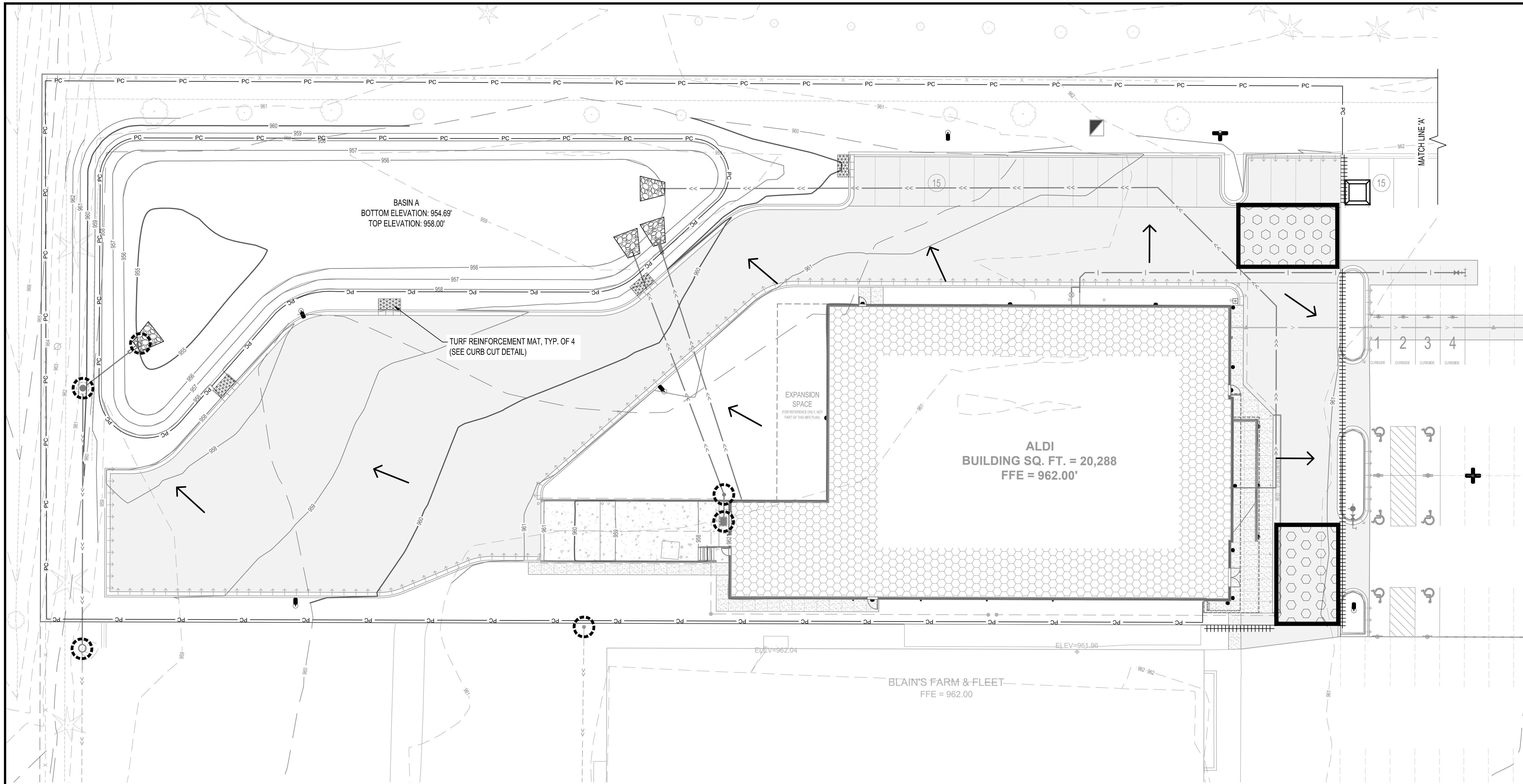

EROSION CONTROL LEGEND	
SYMBOL	DESCRIPTION
	RANDOM RIPRAP, CLASS 3
	PERIMETER CONTROL
	STORM DRAIN INLET PROTECTION
	ROCK CONSTRUCTION EXIT
	TURF REINFORCEMENT MAT, CATEGORY 3
	CONCRETE WASHOUT AREA
	EXISTING DRAINAGE ARROW

	PROPOSED DRAINAGE ARROW
	EXISTING CONTOUR (MINOR INTERVAL)
	EXISTING CONTOUR (MAJOR INTERVAL)
	PROPOSED CONTOUR (MINOR INTERVAL)
	PROPOSED CONTOUR (MAJOR INTERVAL)

PERIMETER CONTROL CAN BE SILT FENCE OR SEDIMENT CONTROL LOG.
SEE SITE RESTORATION PLAN FOR FINAL TURF ESTABLISHMENT.

NOTE: EROSION CONTROL PLAN COVERAGE INCLUDES ELECTRIC, GAS, TELEPHONE, AND CABLE INSTALLATION. EACH COMPANY OR THEIR SUBCONTRACTOR IS RESPONSIBLE TO FOLLOW THE REQUIREMENTS OF THIS PLAN, INCLUDING PROVIDING THEIR OWN RESTORATION IF INSTALLATION OCCURS AFTER PRIMARY INSTALLATION OF SEEDING/SODDING/MULCHING DURING CONSTRUCTION OF EACH UTILITY.

EROSION CONTROL QUANTITIES		
DESCRIPTION	UNITS	QUANTITY
RANDOM RIPRAP, CLASS 3	CY	16
STORM DRAIN INLET PROTECTION	EACH	7
PERIMETER CONTROL	LF	2,010
STABILIZED CONSTRUCTION EXIT	EACH	2
SEDIMENT CONTROL LOG	LF	195
CONCRETE WASHOUT AREA	EA	1

QUANTITIES ARE FOR INFORMATIONAL PURPOSES TO MEET THE REQUIREMENTS OF THE CONSTRUCTION STORMWATER PERMIT. NO GUARANTEE IS MADE TO THE ACTUAL QUANTITIES REQUIRED.

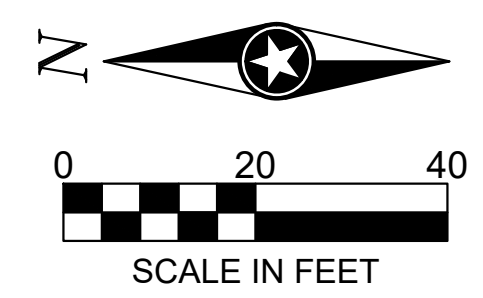

MANAGING LOCATION:
MINNEAPOLIS / ST. PAUL OFFICE
 7900 INTERNATIONAL DRIVE
 INTERNATIONAL PLAZA, SUITE 550
 MINNEAPOLIS, MN 55425
 PHONE: 952.426.0699

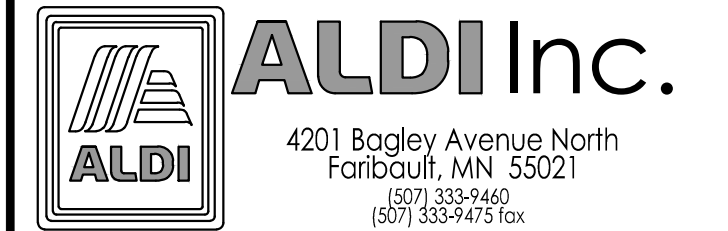

ALDI Inc. Store #: 64
 CEDAR FALLS, IA
 219 BRANDILYNN BLVD
 CEDAR FALLS, IA 50613
 BLACKHAWK COUNTY

Project Name & Location:

SITE EROSION CONTROL PLAN

Drawing Name:

Type: V7.0 ER ISG Project No.

Drawn By: JMF 16-19997

Designed By: JMF C-110

Reviewed By: RJA Drawing No.

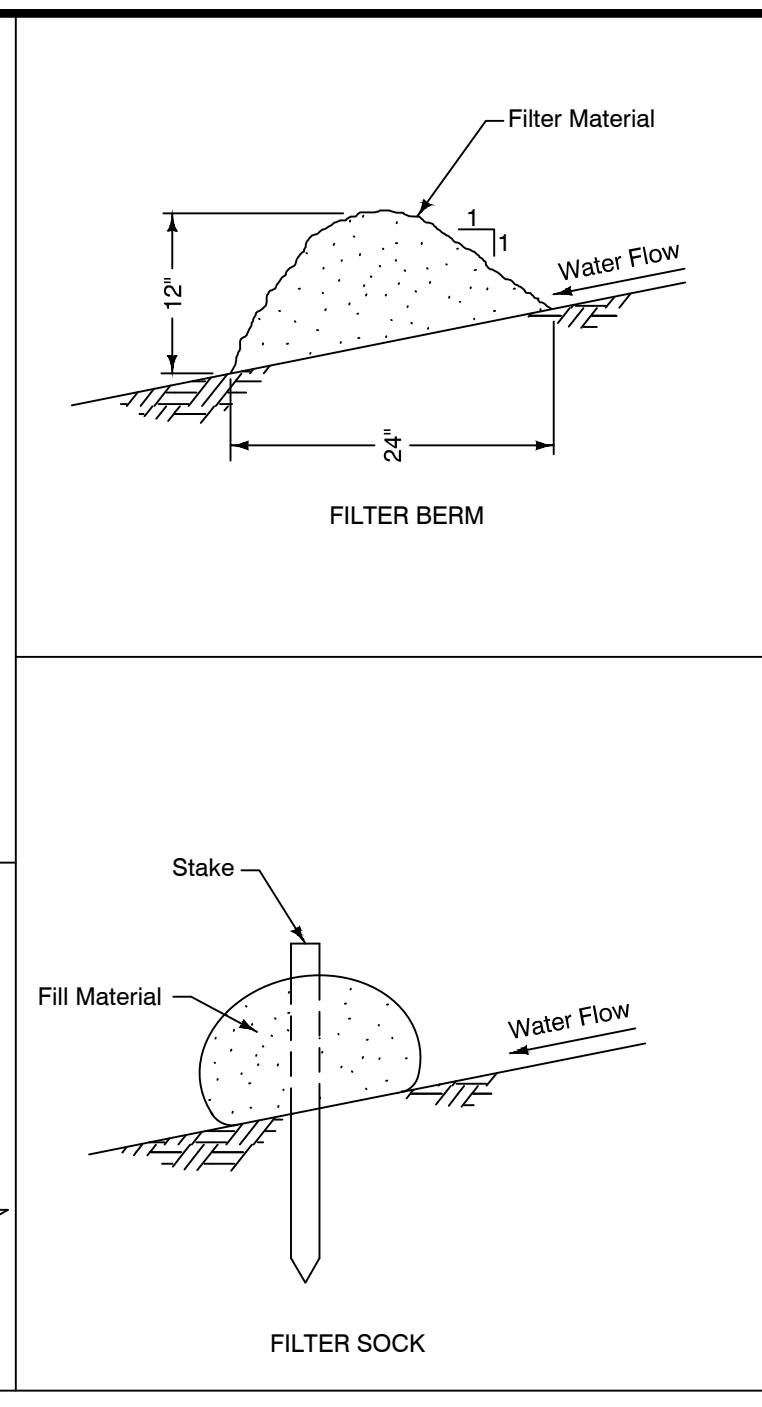
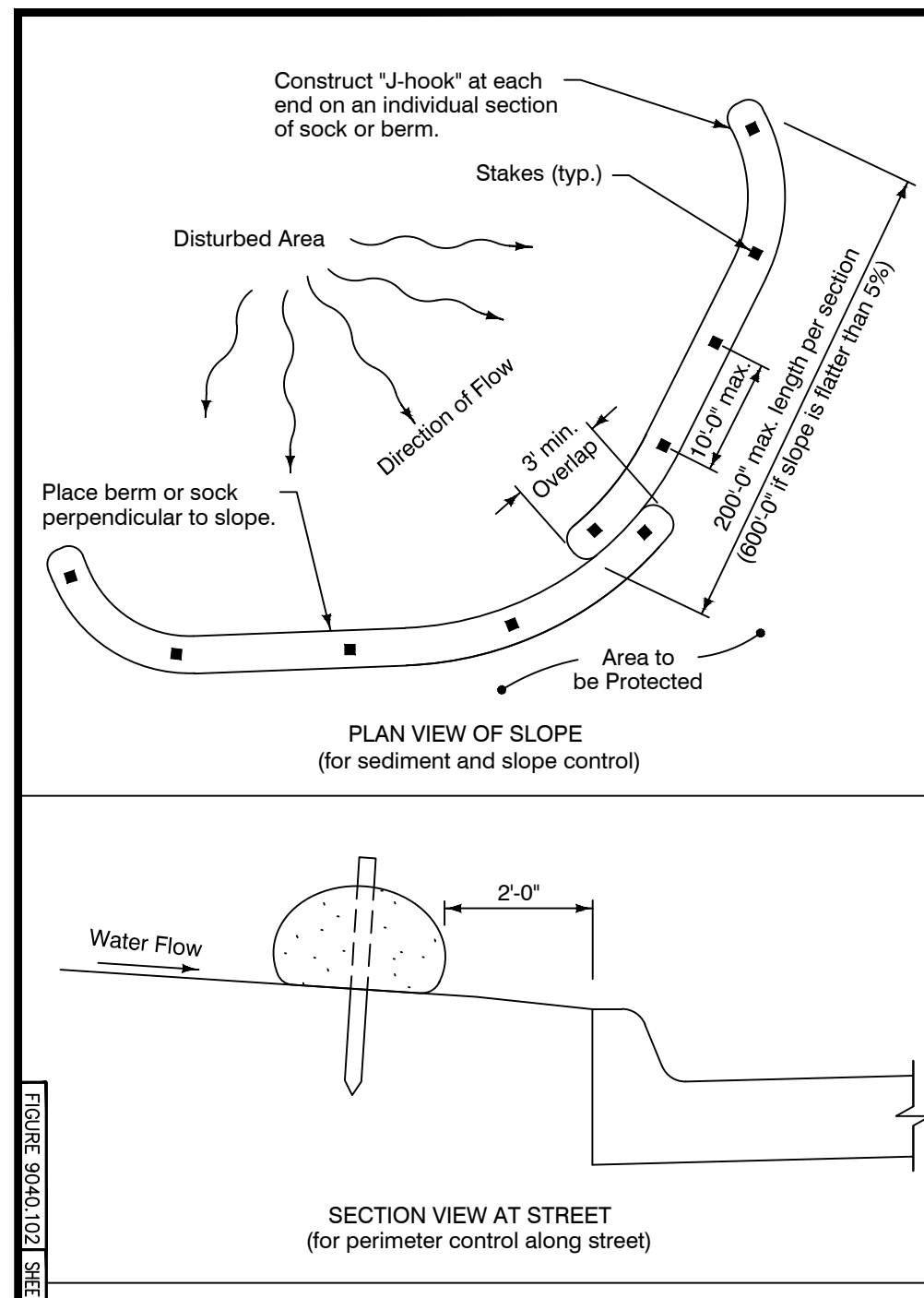

Berm shown is typical for slopes flatter than 3:1. For steeper slopes, increase berm size as directed by the Engineer.

Place berm in uncompacted windrow perpendicular to the slope at locations specified in the contract documents.

Filter sock diameter as specified in the contract documents.

SUDAS 9040.102

REVISIONS: 4 [10-17-17]

SUDAS Standard Specifications

FILTER BERM AND FILTER SOCK

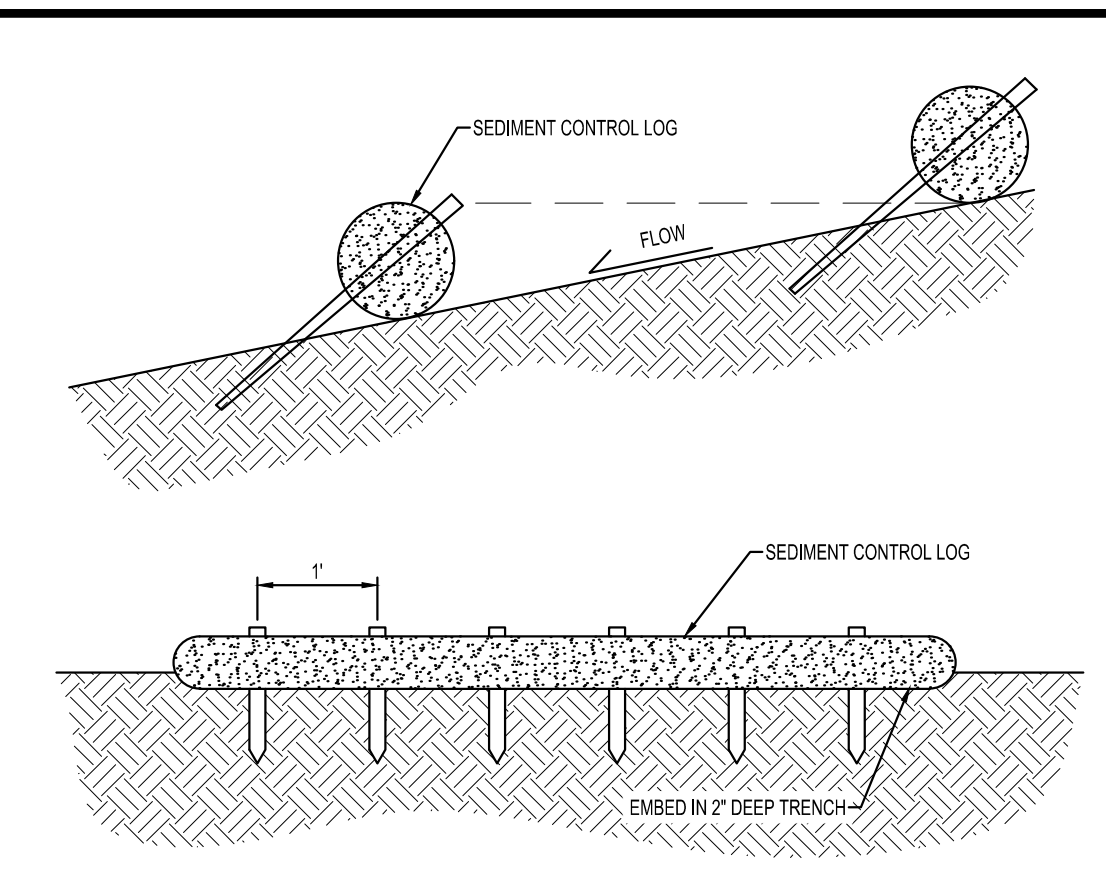

NOTES:

SEDIMENT CONTROL LOGS TO BE 6" DIAMETER UNLESS OTHERWISE NOTED.

STAKED INTO THE GROUND WITH WOOD STAKES.

WOOD STAKES ARE A MINIMUM OF 2"x16"x2" UNLESS PRECLUDED BY PAVED SURFACE OR ROCK.

WOOD STAKES DRIVEN THROUGH BACK HALF OF SEDIMENT CONTROL LOG AT AN APPROXIMATE ANGLE OF 45° WITH THE TOP OF STAKE POINTING UP STREAM.

WHEN MORE THAN ONE SEDIMENT CONTROL LOG IS NEEDED, OVERLAP ENDS A MINIMUM OF 6" AND STAKE

SEDIMENT CONTROL LOG STAKING

NTS EC300

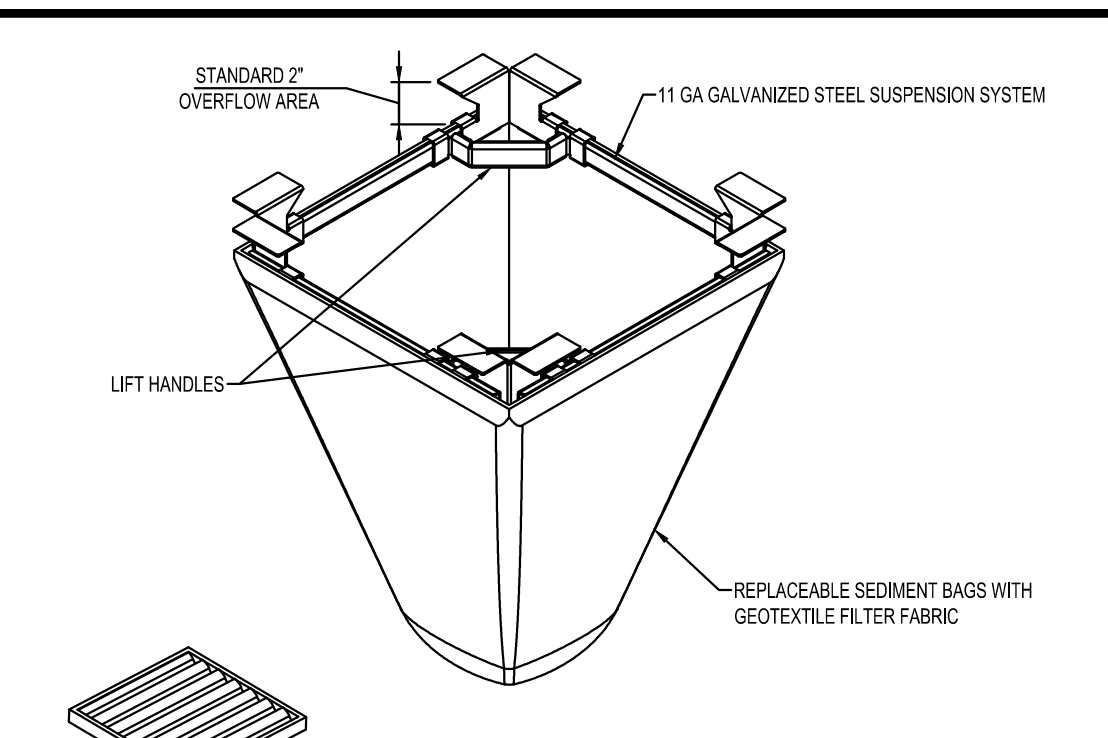

NOTES:

FOR SPECIFICATIONS AND MAINTENANCE GUIDELINES VISIT WWW.INLETFILTERS.COM

INSTALLATION:

REMOVE GRATE

DROP FLEXSTORM INLET FILTER ONTO LOAD BEARING LIP OF CASTING OR CONCRETE STRUCTURE

REPLACE GRATE

MATERIALS:

FRAMING - 11 GAUGE STEEL, CORROSION RESISTANT

SEDIMENT BAG - WOVEN GEOTEXTILE FABRIC, 2 CUBIC FOOT TYP VOLUME

STAINLESS STEEL LOCKING BAND SECURING BAG TO FRAME

RECTANGULAR FILTER INLET PROTECTION

NTS EC211

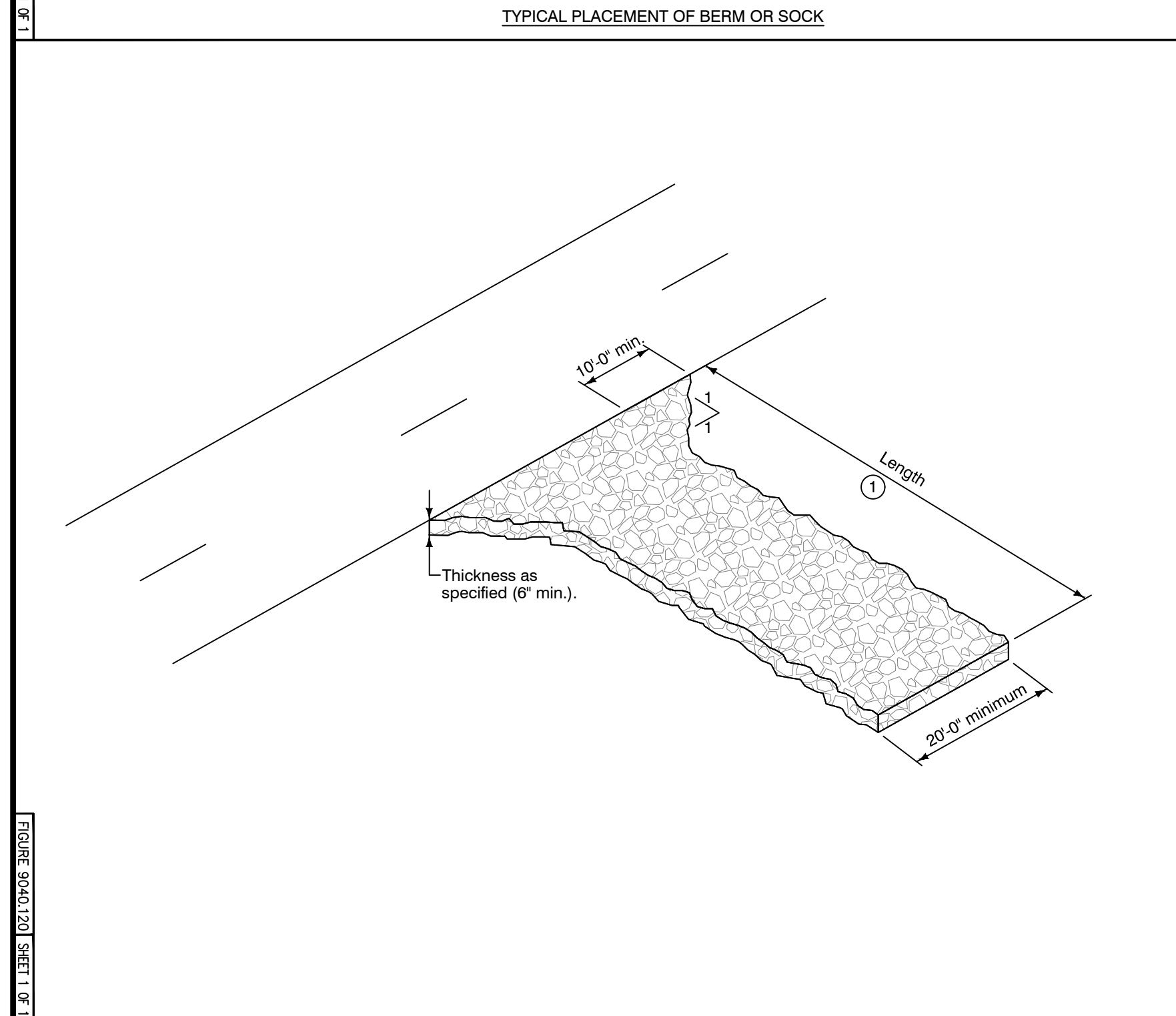

1 Entrance length: 50 foot minimum (30 foot for single family residential), or as specified in the contract documents. Length of entrance may be increased if sediment track-out occurs.

SUDAS 9040.120

REVISIONS: 2 [10-21-14]

SUDAS Standard Specifications

STABILIZED CONSTRUCTION ENTRANCE

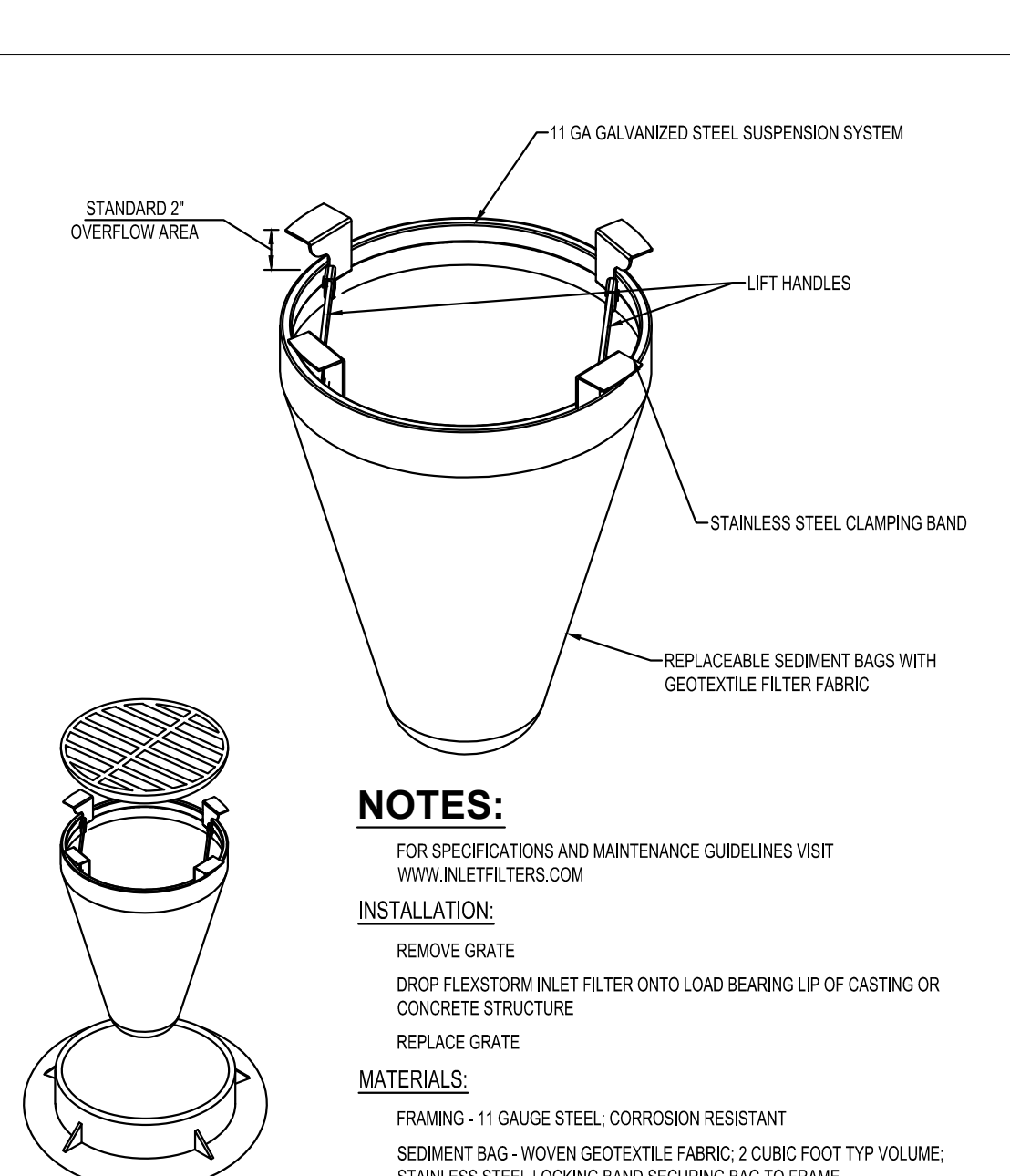

NOTES:

FOR SPECIFICATIONS AND MAINTENANCE GUIDELINES VISIT WWW.INLETFILTERS.COM

INSTALLATION:

REMOVE GRATE

DROP FLEXSTORM INLET FILTER ONTO LOAD BEARING LIP OF CASTING OR CONCRETE STRUCTURE

REPLACE GRATE

MATERIALS:

FRAMING - 11 GAUGE STEEL, CORROSION RESISTANT

SEDIMENT BAG - WOVEN GEOTEXTILE FABRIC, 2 CUBIC FOOT TYP VOLUME

STAINLESS STEEL LOCKING BAND SECURING BAG TO FRAME

ROUND FILTER INLET PROTECTION

NTS EC210

Issued:	Date:
A SITE PLAN SUBMITTAL	02/19/21
B PERMIT SET	03/19/21
C BID SET	04/05/21
D	
E	
Revisions:	Date:
1	
2	
3	
4	
5	
6	
7	
8	
9	



MANAGING LOCATION:
MINNEAPOLIS / ST. PAUL OFFICE
 7900 INTERNATIONAL DRIVE
 INTERNATIONAL PLAZA, SUITE 550
 MINNEAPOLIS, MN 55425
 PHONE: 952.426.0699

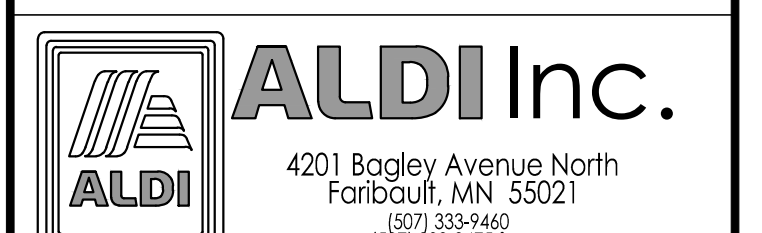

ALDI Inc. Store #: 64
 CEDAR FALLS, IA
 219 BRANDILYNN BLVD
 CEDAR FALLS, IA 50613
 BLACKHAWK COUNTY
 Project Name & Location:

SITE EROSION CONTROL DETAILS

Drawing Name:

Type: V7.0 ER

Drawn By: JMF

Designed By: JMF

Reviewed By: RJA

ISG Project No.
 16-19997

C-120

Drawing No.

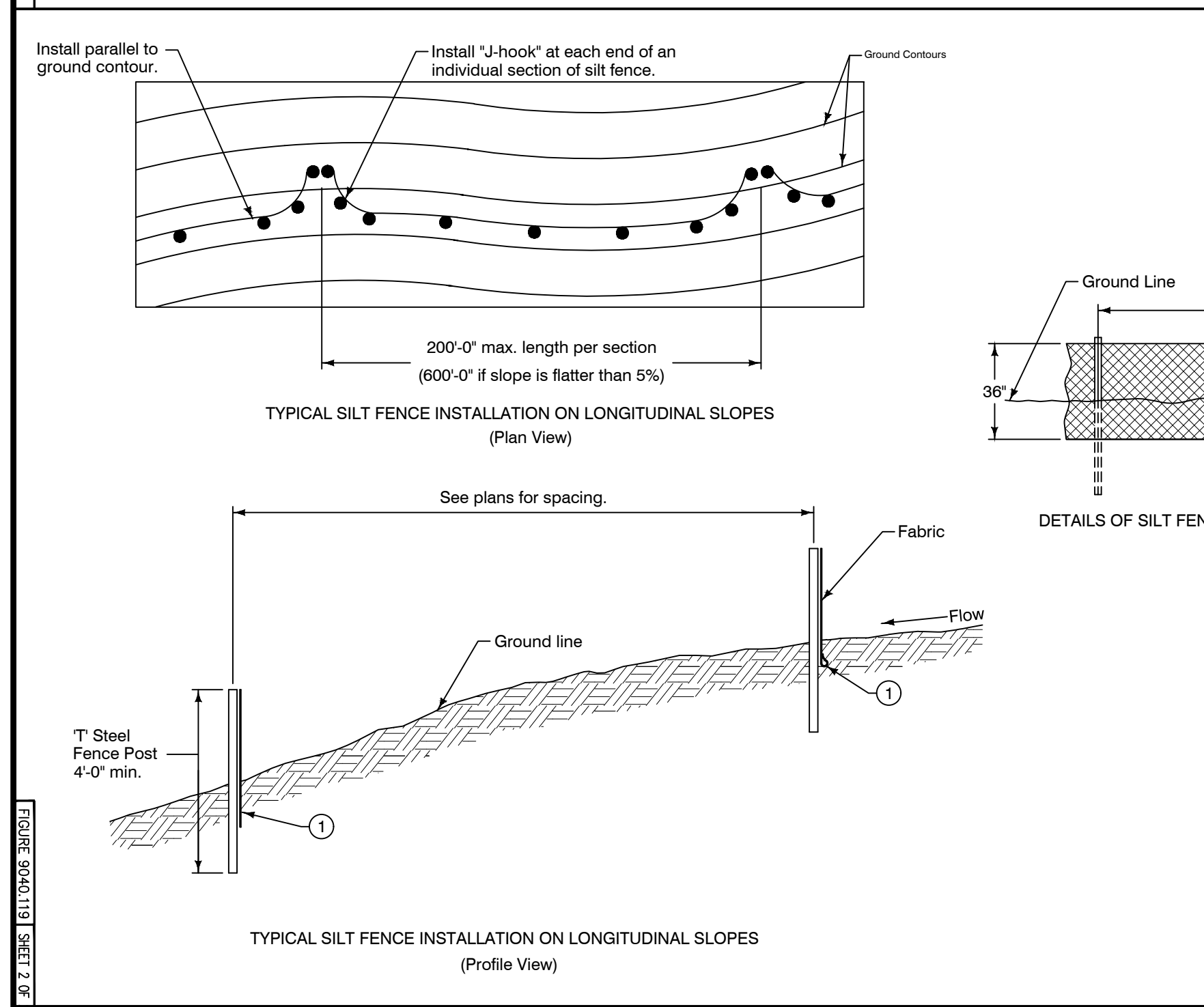

1 Insert 12 inches of fabric a minimum of 6 inches deep (fabric may be folded below the ground line).

2 Reduce post spacing to 5'-0" at water concentration areas, or as required to adequately support fence.

Ground Line

8'-0" Spacing

Fabric

24"

36"

DETAILS OF SILT FENCE ON LONGITUDINAL SLOPES

SUDAS 9040.119

REVISIONS: 2 [10-21-14]

SUDAS Standard Specifications

SILT FENCE

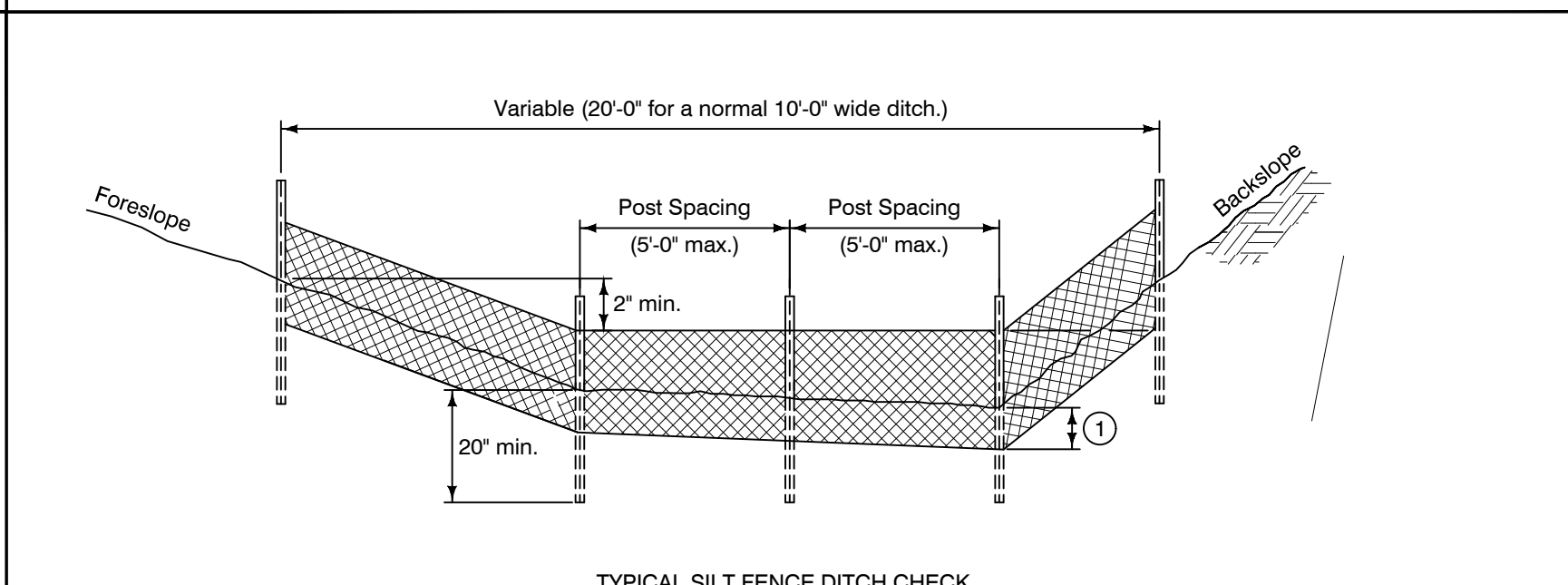

1 Insert 12 inches of fabric a minimum of 6 inches deep (fabric may be folded below the ground line).

Wire or Cable Ties

Fabric

Post

ATTACHMENT TO POST

SUDAS 9040.119

REVISIONS: 2 [10-21-14]

SUDAS Standard Specifications

SILT FENCE

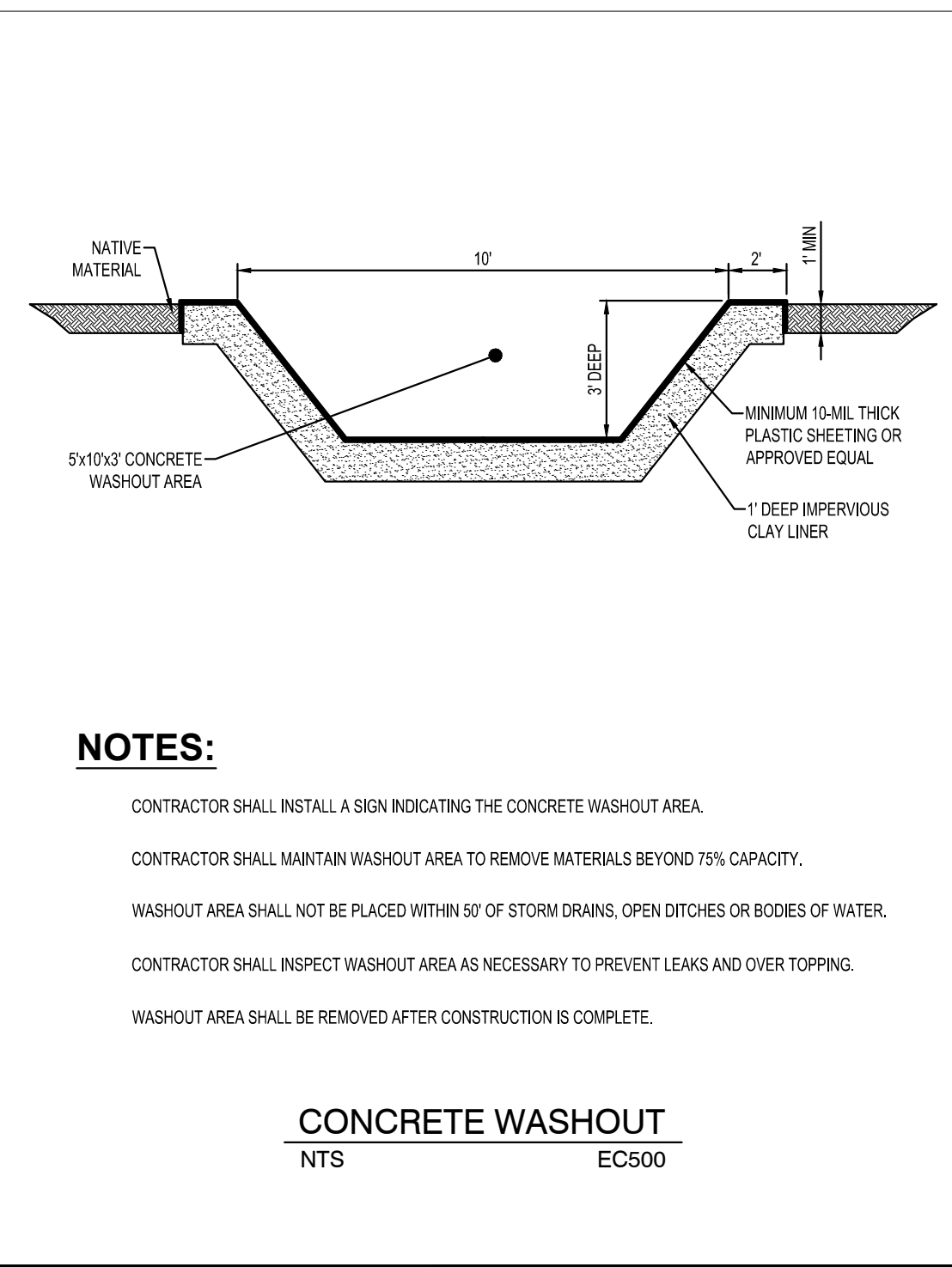

NOTES:

CONTRACTOR SHALL INSTALL A SIGN INDICATING THE CONCRETE WASHOUT AREA.

CONTRACTOR SHALL MAINTAIN WASHOUT AREA TO REMOVE MATERIALS BEYOND 75% CAPACITY.

WASHOUT AREA SHALL NOT BE PLACED WITHIN 50' OF STORM DRAINS, OPEN DITCHES OR BODIES OF WATER.

CONTRACTOR SHALL INSPECT WASHOUT AREA AS NECESSARY TO PREVENT LEAKS AND OVER TOPPING.

WASHOUT AREA SHALL BE REMOVED AFTER CONSTRUCTION IS COMPLETE.

CONCRETE WASHOUT

NTS EC500

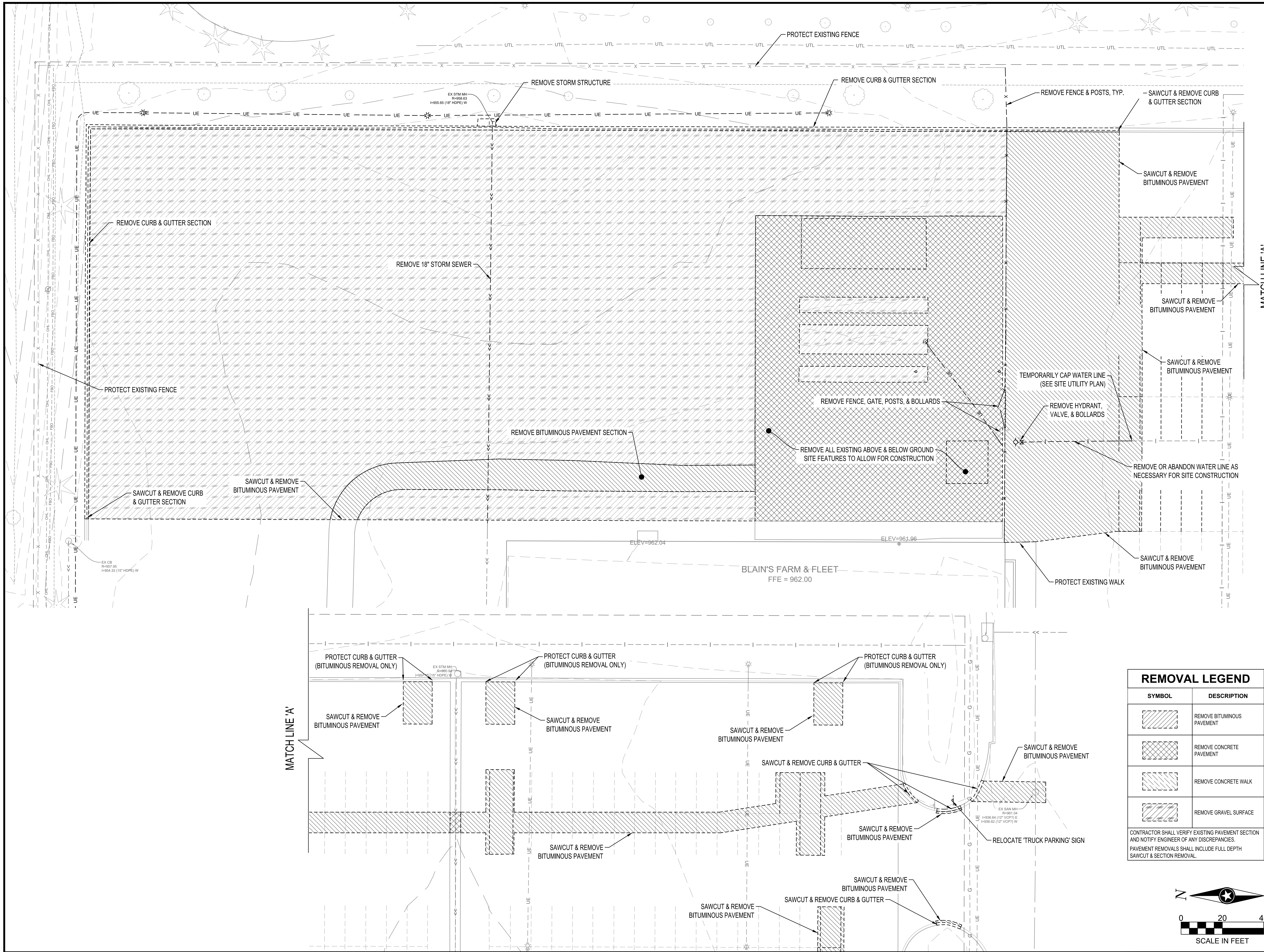

Issued:	Date:
A SITE PLAN SUBMITTAL	02/19/21
B PERMIT SET	03/19/21
C BID SET	04/05/21
D	
E	

Revisions:	Date:
1	
2	
3	
4	
5	
6	
7	
8	
9	



MANAGING LOCATION:
MINNEAPOLIS / ST. PAUL OFFICE
 7900 INTERNATIONAL DRIVE
 INTERNATIONAL PLAZA, SUITE 550
 MINNEAPOLIS, MN 55425
 PHONE: 952.426.0699

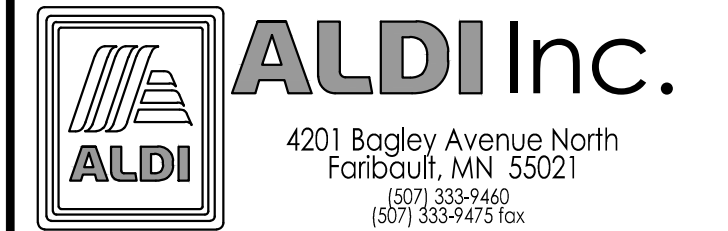

ALDI Inc. Store #: 64
CEDAR FALLS, IA
 219 BRANDILYNN BLVD
 CEDAR FALLS, IA 50613
 BLACKHAWK COUNTY
 Project Name & Location:

EXISTING SITE & REMOVAL PLAN

Drawing Name:	ISG Project No.
Type: V7.0 ER	16-19997
Drawn By: JMF	C-210
Designed By: JMF	Drawing No.
Reviewed By: RJA	

REMOVAL LEGEND	
SYMBOL	DESCRIPTION
	REMOVE BITUMINOUS PAVEMENT
	REMOVE CONCRETE PAVEMENT
	REMOVE CONCRETE WALK
	REMOVE GRAVEL SURFACE

CONTRACTOR SHALL VERIFY EXISTING PAVEMENT SECTION AND NOTIFY ENGINEER OF ANY DISCREPANCIES.
 PAVEMENT REMOVALS SHALL INCLUDE FULL DEPTH SAWCUT & SECTION REMOVAL.

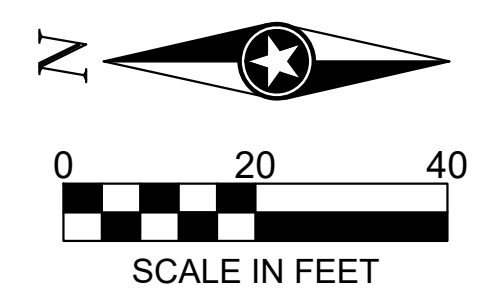

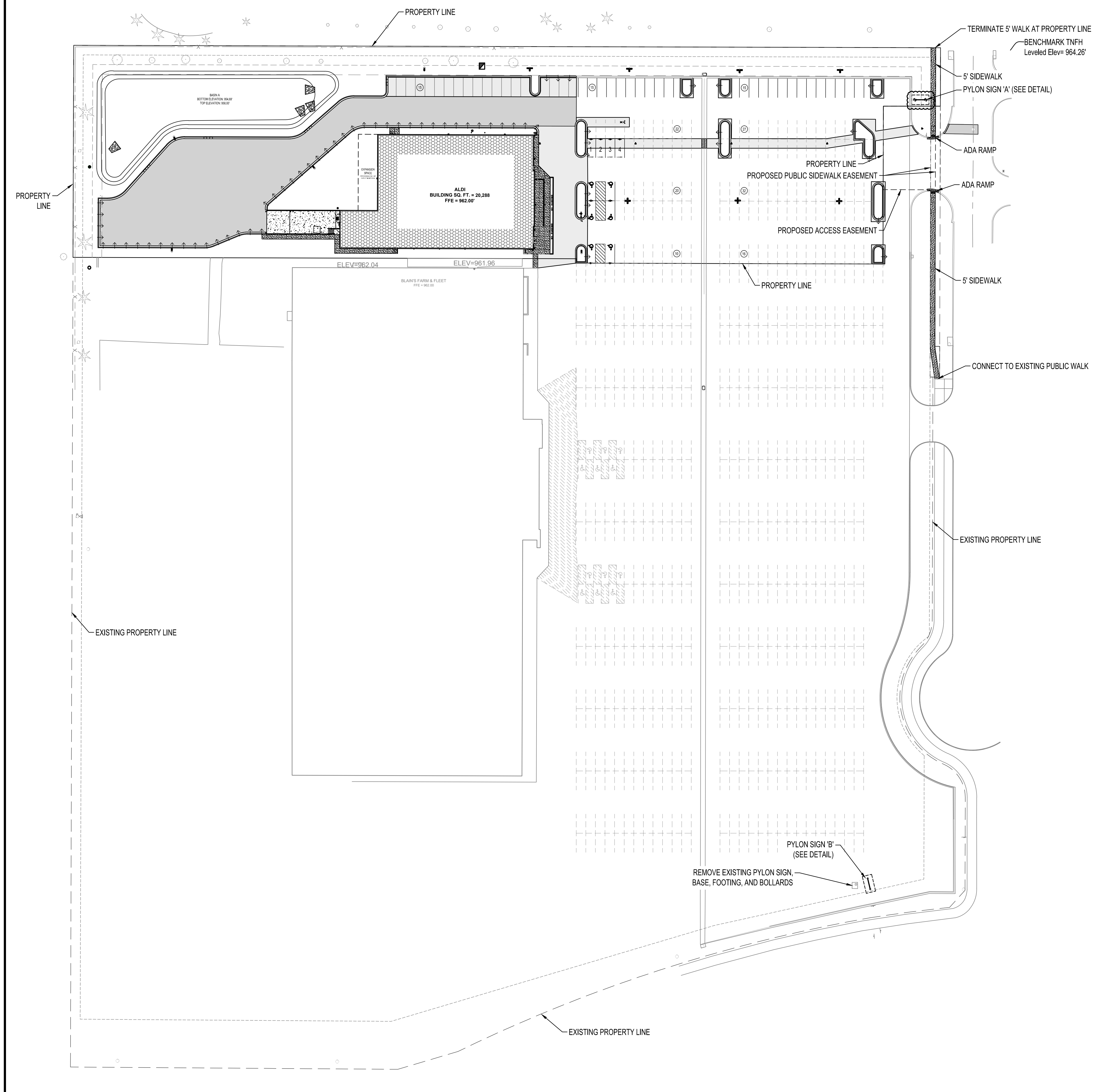

BID ITEMS:

BASE BID: CONSISTS OF ALL WORK AS SHOWN WITHIN THIS PLAN SET.

BID ALTERNATE #4: SEAL COAT AND CRACK FILL ALL EXISTING PAVEMENT WITHIN THE ALDI PROPERTY BOUNDARY NOT BEING REPLACED AS PART OF THE BASE BID.

BID ALTERNATE #5: PERFORM 1.5" MILL AND OVERLAY OF ALL EXISTING PAVEMENT WITHIN THE ALDI PROPERTY BOUNDARY NOT BEING REPLACED AS PART OF THE BASE BID.

Issued:	Date:
A SITE PLAN SUBMITTAL	02/19/21
B PERMIT SET	03/19/21
C BID SET	04/05/21
D	
E	

Revisions:	Date:
1 ADDENDUM 1	04/16/21
2	
3	
4	
5	
6	
7	
8	
9	



MANAGING LOCATION:
MINNEAPOLIS / ST. PAUL OFFICE
 7900 INTERNATIONAL DRIVE
 INTERNATIONAL PLAZA, SUITE 550
 MINNEAPOLIS, MN 55425
 PHONE: 952.426.0699

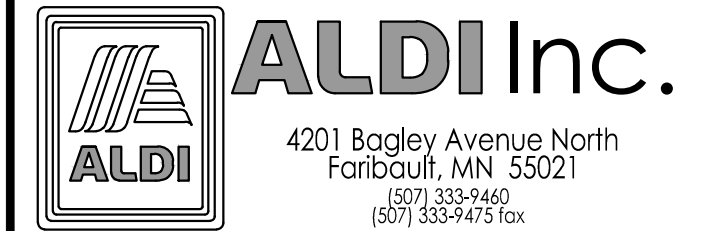

ALDI Inc. Store #: 64
CEDAR FALLS, IA
 219 BRANDILYNN BLVD
 CEDAR FALLS, IA 50613
 BLACKHAWK COUNTY
 Project Name & Location:

OVERALL SITE PLAN

Drawing Name:	ISG Project No.
Type: V7.0 ER	16-19997
Drawn By: JMF	C-300
Designed By: JMF	Drawing No.
Reviewed By: RJA	

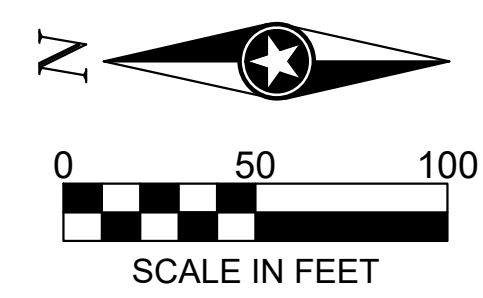

Issued:	Date:
A SITE PLAN SUBMITAL	02/19/21
B PERMIT SET	03/19/21
C BID SET	04/05/21
D	
E	
Revisions:	Date:
1	
2	
3	
4	
5	
6	
7	
8	
9	

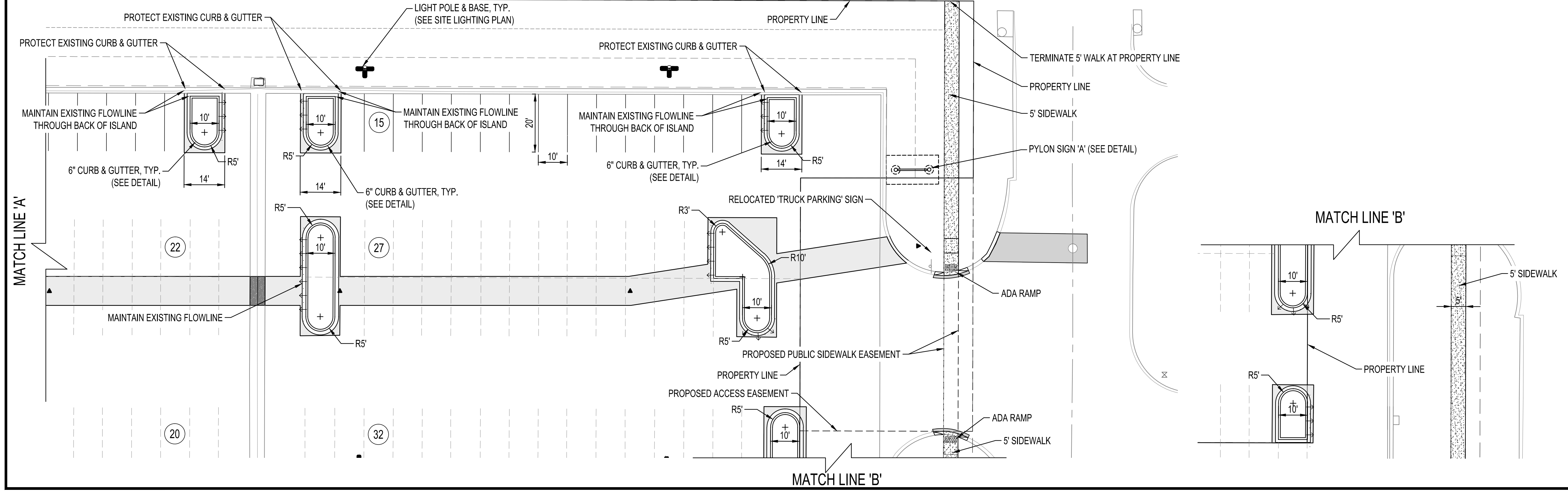
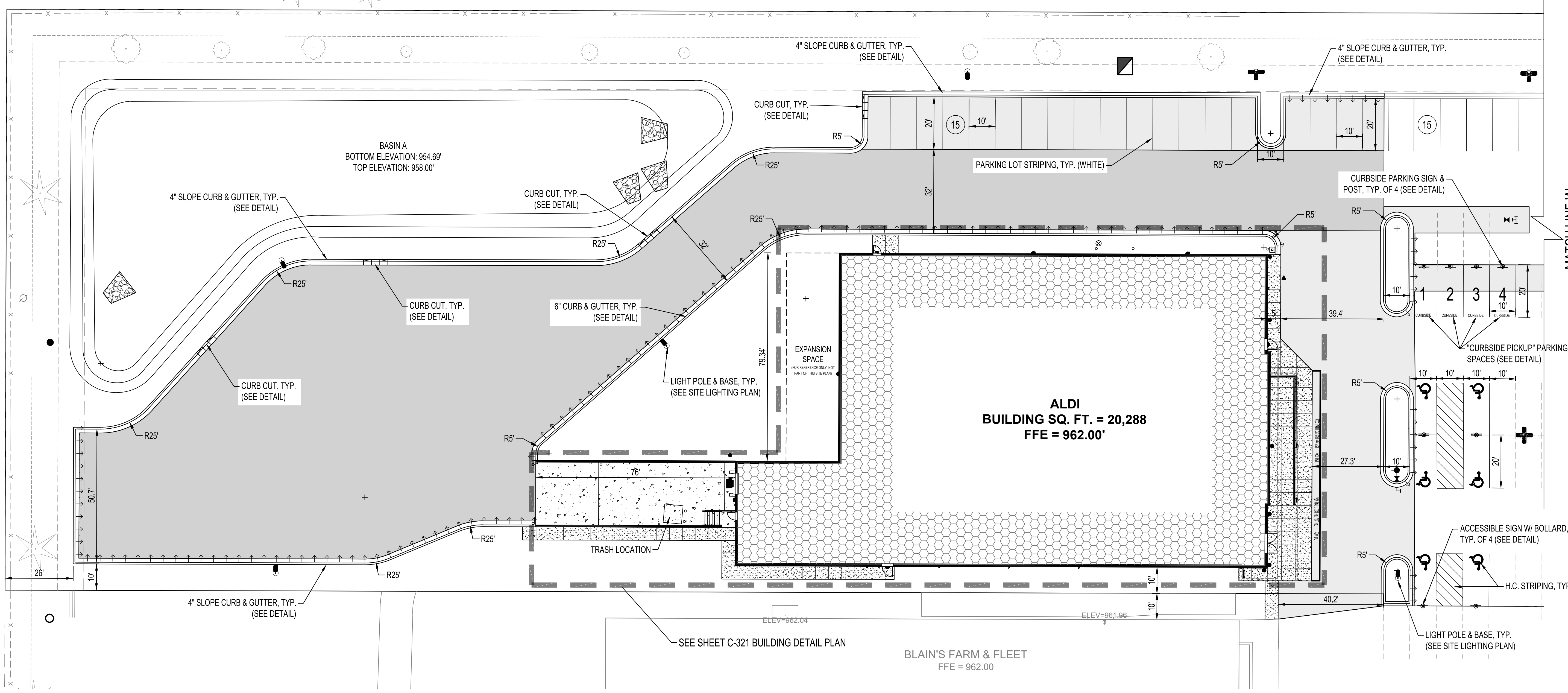

PAVEMENT LEGEND	
SYMBOL	DESCRIPTION
[Symbol]	BITUMINOUS PAVEMENT
[Symbol]	HEAVY DUTY BITUMINOUS PAVEMENT
[Symbol]	CONCRETE WALK
[Symbol]	REVERSE PITCH CONCRETE CURB & GUTTER

NOTE: F&I: ALL PARKING LOT STRIPING AND MARKINGS AS SHOWN

NOTE: ALDI MAILBOX & POST LOCATION TO BE DETERMINED BY U.S. POSTMASTER (SEE DETAIL FOR DESIGN CRITERIA)

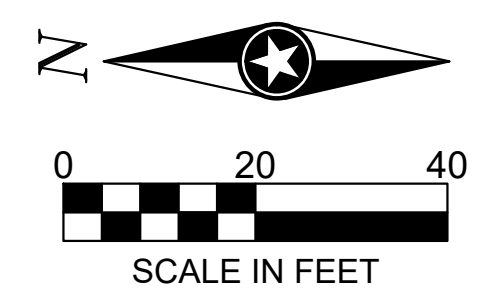

MANAGING LOCATION:
MINNEAPOLIS / ST. PAUL OFFICE
7900 INTERNATIONAL DRIVE
INTERNATIONAL PLAZA, SUITE 550
MINNEAPOLIS, MN 55425
PHONE: 952.426.0699

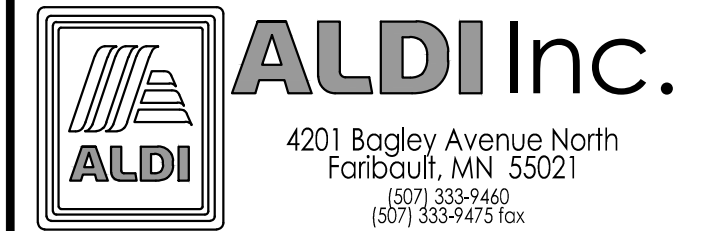

ALDI Inc. Store #: 64
CEDAR FALLS, IA
219 BRANDILYNN BLVD
CEDAR FALLS, IA 50613
BLACKHAWK COUNTY
Project Name & Location:

SITE PLAN	
Drawing Name:	ISG Project No.
Type: V7.0 ER	16-19997
Drawn By: JMF	C-310
Designed By: JMF	Drawing No.
Reviewed By: RJA	

Issued:	Date:
A SITE PLAN SUBMITTAL	02/19/21
B PERMIT SET	03/19/21
C BID SET	04/05/21
D	
E	

Revisions:	Date:
1 ADDENDUM 1	04/16/21
2	
3	
4	
5	
6	
7	
8	
9	

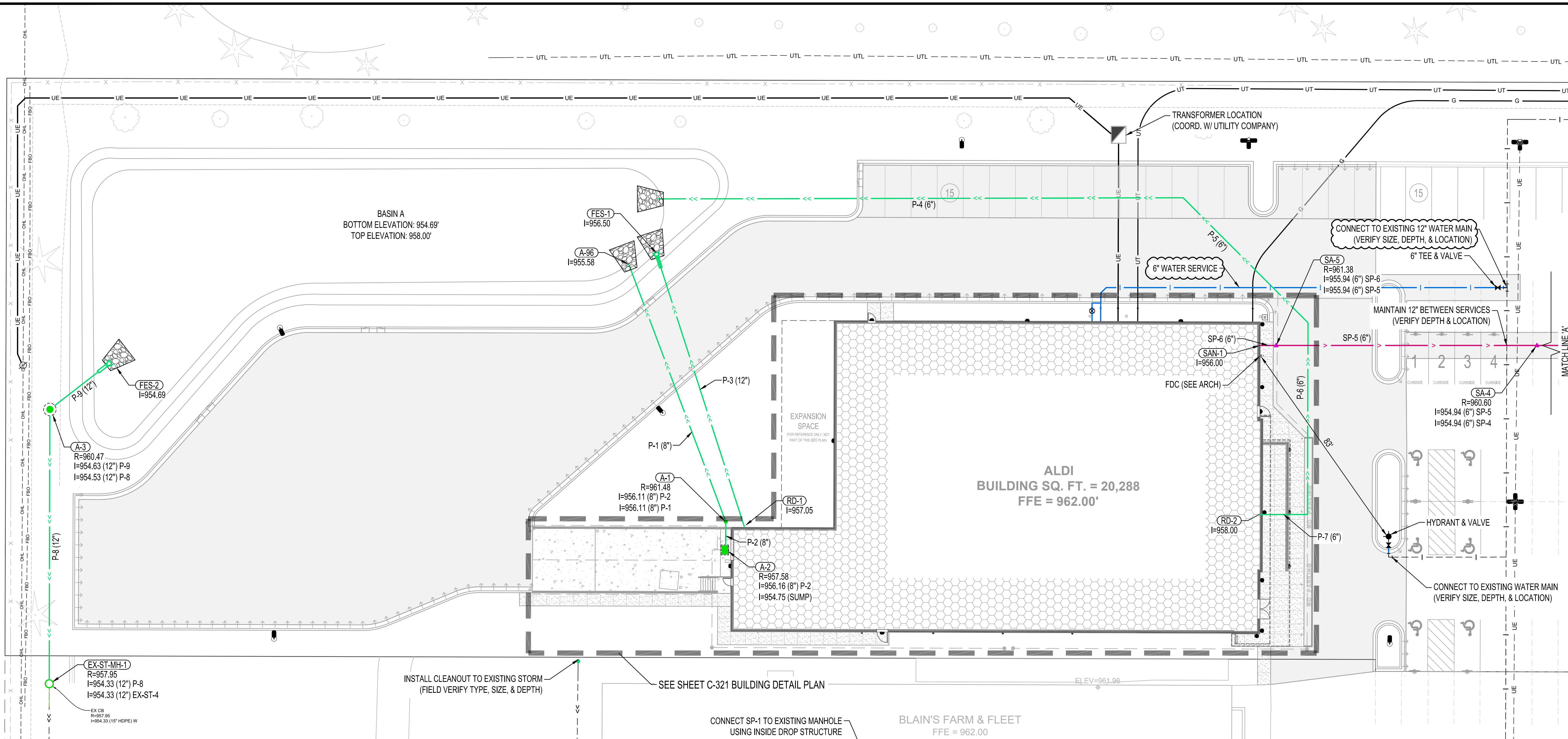

NOTES:

- ALL UTILITIES ARE TO BE CONSTRUCTED TO 5' OUTSIDE OF BUILDING AND ARE TO BE CONNECTED TO BUILDING BY MECHANICAL/PLUMBING CONTRACTOR.
- ENSURE 18" VERTICAL BETWEEN ALL PROPOSED & EXISTING WATER, STORM, & SANITARY.
- R = TOP BACK OF CURB ELEVATIONS FOR CURB STYLE CATCH BASINS, NOT GUTTER ELEVATIONS

EXISTING		PROPOSED	
---	>>	---	>>
---	>	---	>
---		---	<
---		---	
---	G	---	G
---	OE	---	OE
---	UE	---	UE
---	UT	---	UT
---	UTV	---	UTV
---	OHL	---	OHL
---	UTL	---	UTL
---	FBO	---	FBO

UTILITY LEGEND

NOTE:
CONTRACTOR SHALL FIELD VERIFY THE LOCATIONS OF ALL EXISTING UTILITIES.

SANITARY SEWER STRUCTURE SCHEDULE							
STRUCTURE NO.	STRUCTURE TYPE	STRUCTURE SIZE (in)	STRUCTURE MATERIAL	CASTING	TOP OF CASTING ELEVATION	INVERT ELEVATION	OUTLET PIPE
SA-1	CLEANOUT	6 Ø	PVC	SOLID	962.28	951.94	SP-1
SA-2	CLEANOUT	6 Ø	PVC	SOLID	961.26	952.94	SP-2
SA-3	CLEANOUT	6 Ø	PVC	SOLID	960.33	953.94	SP-3
SA-4	CLEANOUT	6 Ø	PVC	SOLID	960.60	954.94	SP-4
SA-5	CLEANOUT	6 Ø	PVC	SOLID	961.38	955.94	SP-5

STORM DRAIN PIPE SCHEDULE								
PIPE NO.	DRAIN FROM	INLET ELEVATION	DRAIN TO	OUTLET ELEVATION	PIPE SIZE (IN)	MATERIAL	PIPE GRADE	PIPE LENGTH (FT)
P-1	A-1	956.11	A-96	955.58	8	PVC	0.50%	105
P-2	A-2	956.16	A-1	956.11	8	PVC	0.50%	11
P-3	RD-1	957.05	FES-1	956.50	12	HDPE	0.50%	110
P-4	A-88	957.11	A-87	956.00	6	PVC	0.55%	201
P-5	A-89	957.48	A-88	957.11	6	PVC	0.55%	68
P-6	A-90	957.88	A-89	957.48	6	PVC	0.55%	73
P-7	RD-2	958.00	A-90	957.89	6	PVC	0.62%	18
P-8	A-3	954.53	EX-ST-MH-1	954.33	12	HDPE	0.19%	105
P-9	FES-2	954.69	A-3	954.63	12	HDPE	0.19%	29

STORM DRAIN APRON SCHEDULE				
APRON NO.	APRON SIZE (in)	APRON MATERIAL	INVERT ELEVATION	PIPE NO.
FES-1	12	HDPE	956.50	P-3
FES-2	12	HDPE	954.69	P-9

STORM DRAIN STRUCTURE SCHEDULE							
STRUCTURE NO.	STRUCTURE TYPE	STRUCTURE SIZE (in)	STRUCTURE MATERIAL	CASTING	* TOP OF CASTING ELEVATION	INVERT ELEVATION	OUTLET PIPE
A-1	CLEANOUT	8 Ø	PVC	SOLID	961.48	956.11	P-1
A-2	SEE DETAIL	36 x 24	RC	NEENAH-R3210-Q	957.58	954.75	P-2
A-3	SW-401	48 Ø	RC	OVERFLOW GRATE	960.47	954.53	P-8

SANITARY SEWER PIPE SCHEDULE									
PIPE NO.	DRAIN FROM	INLET ELEVATION	DRAIN TO	OUTLET ELEVATION	PIPE SIZE	MATERIAL	PIPE CLASS	PIPE GRADE	PIPE LENGTH (FT)
SP-1	SA-1	951.94	EX-SAN-MH-1	951.41	6"	PVC	SDR-26	1.00%	53
SP-2	SA-2	952.94	SA-1	951.94	6"	PVC	SDR-26	1.00%	100
SP-3	SA-3	953.94	SA-2	952.94	6"	PVC	SDR-26	1.00%	100
SP-4	SA-4	954.94	SA-3	953.94	6"	PVC	SDR-26	1.00%	100
SP-5	SA-5	955.94	SA-4	954.94	6"	PVC	SDR-26	1.00%	100
SP-6	SAN-1	956.00	SA-5	955.94	6"	PVC	SDR-26	1.00%	6

MANAGING LOCATION:
MINNEAPOLIS / ST. PAUL OFFICE
7900 INTERNATIONAL DRIVE
INTERNATIONAL PLAZA, SUITE 550
MINNEAPOLIS, MN 55425
PHONE: 952.426.0699

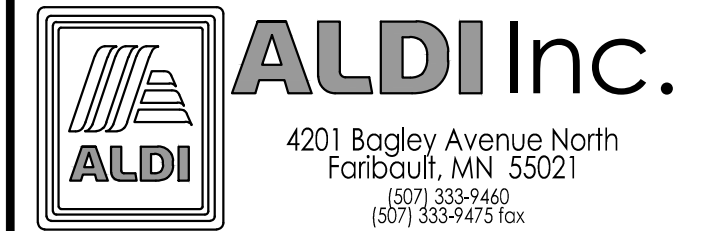

ALDI Inc. Store #: 64
CEDAR FALLS, IA
219 BRANDILYNN BLVD
CEDAR FALLS, IA 50613
BLACKHAWK COUNTY
Project Name & Location:

SITE UTILITY PLAN

Drawing Name:	ISG Project No.
Type: V7.0 ER	16-19997
Drawn By: JMF	C-320
Designed By: JMF	Drawing No.
Reviewed By: RJA	

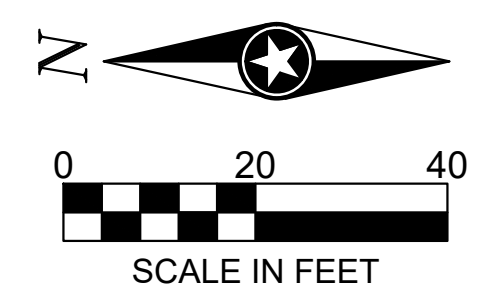

Issued:		Date:
A	SITE PLAN SUBMITTAL	02/19/21
B	PERMIT SET	03/19/21
C	BID SET	04/05/21
D		
E		

Revisions:		Date:
1		
2		
3		
4		
5		
6		
7		
8		
9		

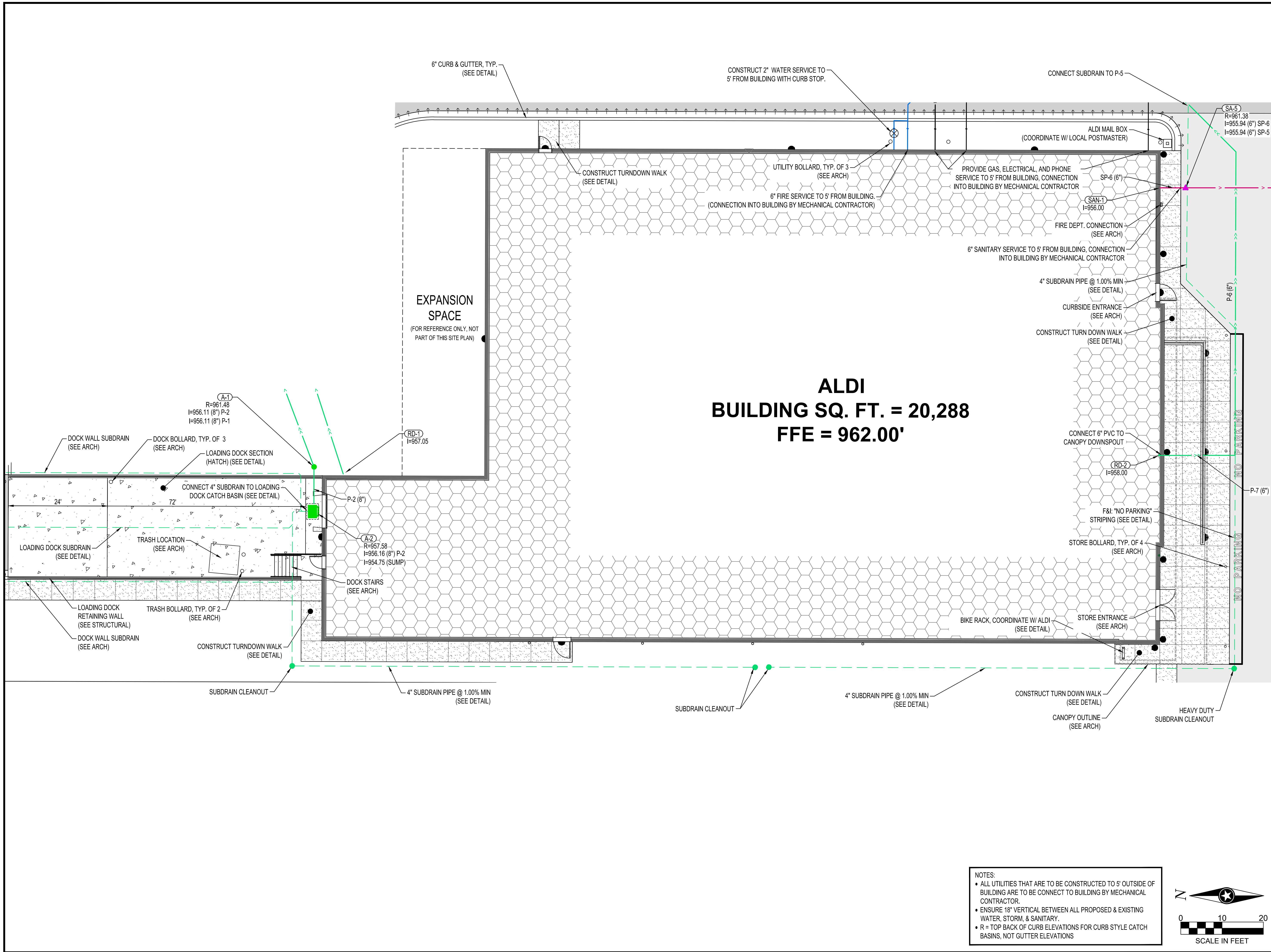

ALDI
BUILDING SQ. FT. = 20,288
FFE = 962.00'



MANAGING LOCATION:
MINNEAPOLIS / ST. PAUL OFFICE
 7900 INTERNATIONAL DRIVE
 INTERNATIONAL PLAZA, SUITE 550
 MINNEAPOLIS, MN 55425
 PHONE: 952.426.0699



ALDI Inc. Store #: 64
CEDAR FALLS, IA
 219 BRANDILYNN BLVD
 CEDAR FALLS, IA 50613
 BLACKHAWK COUNTY
 Project Name & Location:

BUILDING DETAIL PLAN

Drawing Name:	ISG Project No.
Type: V7.0 ER	16-19997
Drawn By: JMF	
Designed By: JMF	C-321
Reviewed By: RJA	Drawing No.

- NOTES:**
- ALL UTILITIES THAT ARE TO BE CONSTRUCTED TO 5' OUTSIDE OF BUILDING ARE TO BE CONNECT TO BUILDING BY MECHANICAL CONTRACTOR.
 - ENSURE 18" VERTICAL BETWEEN ALL PROPOSED & EXISTING WATER, STORM, & SANITARY.
 - R = TOP BACK OF CURB ELEVATIONS FOR CURB STYLE CATCH BASINS, NOT GUTTER ELEVATIONS

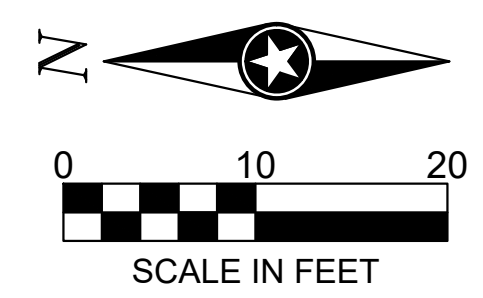

Issued:		Date:
A	SITE PLAN SUBMITTAL	02/19/21
B	PERMIT SET	03/19/21
C	BID SET	04/05/21
D		
E		
Revisions:		Date:
1		
2		
3		
4		
5		
6		
7		
8		
9		

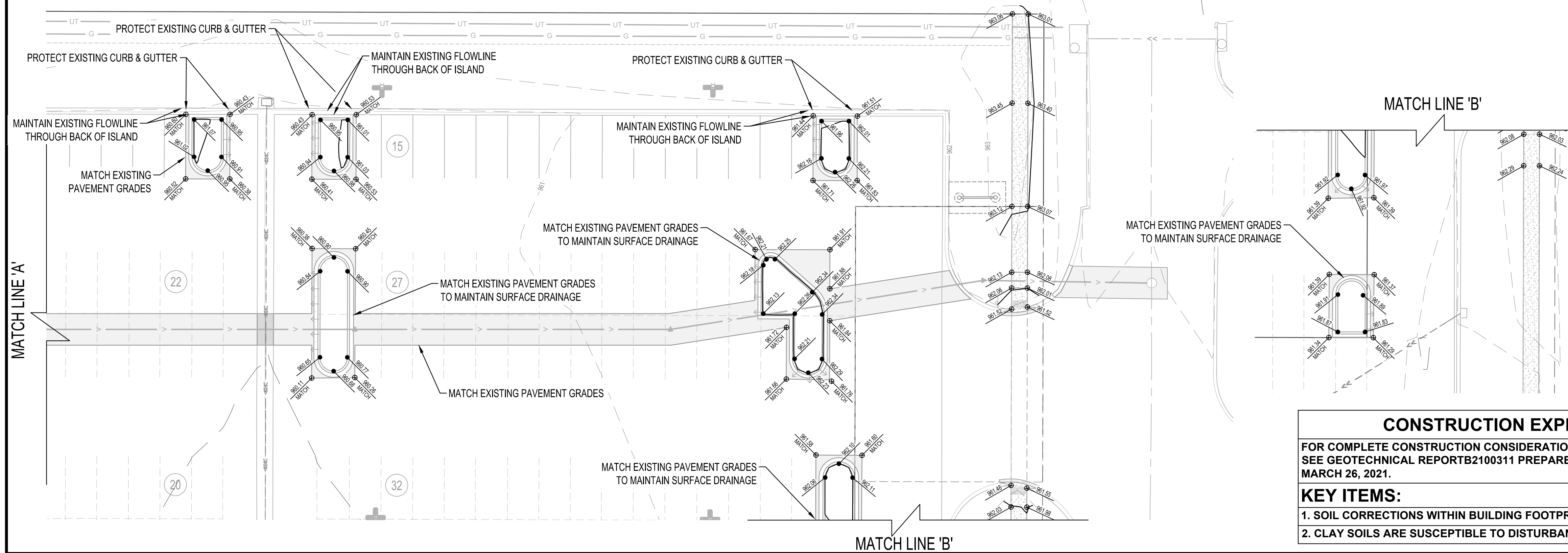
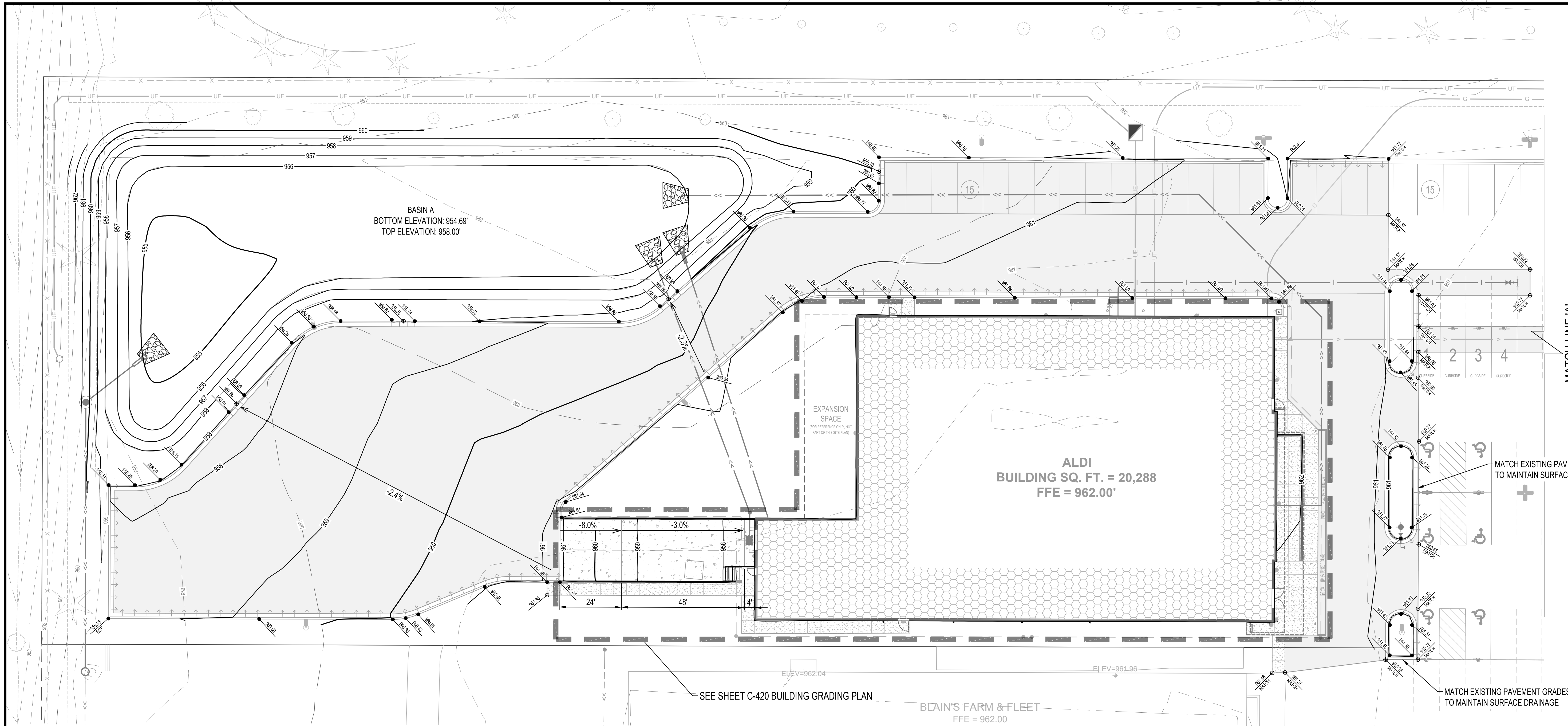

GRADING LEGEND	
---101---	EXISTING CONTOUR (MINOR INTERVAL)
---100---	EXISTING CONTOUR (MAJOR INTERVAL)
—101—	PROPOSED CONTOUR (MINOR INTERVAL)
—100—	PROPOSED CONTOUR (MAJOR INTERVAL)
● 96.12	PROPOSED SPOT ELEVATION
● 96.12	PROPOSED TOP BACK OF CURB SPOT ELEVATION
-X.X%	SURFACE GRADE / DIRECTION

GENERAL GRADING NOTES
 PROPOSED CONTOURS SHOW FINISHED GRADE ELEVATIONS. BUILDING PAD AND PAVEMENT HOLD DOWNS ARE NOT INCLUDED. WHEN CONSTRUCTING BUILDING PADS WITH A HOLD DOWN, GRADE AREAS TO ENSURE POSITIVE BUILDING PAD DRAINAGE.

CONSTRUCTION EXPECTATIONS
 FOR COMPLETE CONSTRUCTION CONSIDERATIONS AND EXPECTED CONDITIONS, SEE GEOTECHNICAL REPORT B2100311 PREPARED BY BRAUN INTERTEC DATED MARCH 26, 2021.

KEY ITEMS:
 1. SOIL CORRECTIONS WITHIN BUILDING FOOTPRINT.
 2. CLAY SOILS ARE SUSCEPTIBLE TO DISTURBANCE AND MOISTURE.

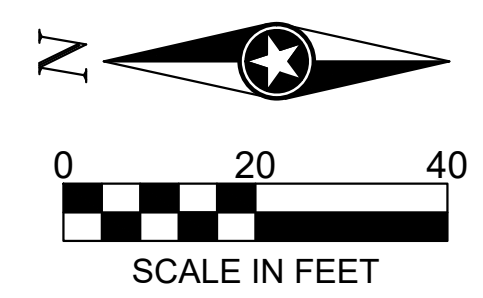

MANAGING LOCATION:
 MINNEAPOLIS / ST. PAUL OFFICE
 7900 INTERNATIONAL DRIVE
 INTERNATIONAL PLAZA, SUITE 550
 MINNEAPOLIS, MN 55425
 PHONE: 952.426.0699

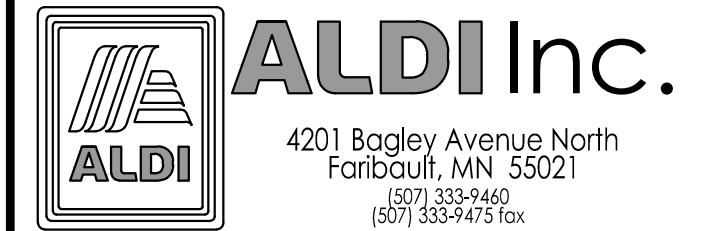

ALDI Inc. Store #: 64
 CEDAR FALLS, IA
 219 BRANDILYNN BLVD
 CEDAR FALLS, IA 50613
 BLACKHAWK COUNTY
 Project Name & Location:

SITE GRADING PLAN

Drawing Name:	ISG Project No.
Type: V7.0 ER	16-19997
Drawn By: JMF	
Designed By: JMF	C-410
Reviewed By: RJA	Drawing No.

Issued:	Date:
A SITE PLAN SUBMITTAL	02/19/21
B PERMIT SET	03/19/21
C BID SET	04/05/21
D	
E	
Revisions:	Date:
1	
2	
3	
4	
5	
6	
7	
8	
9	

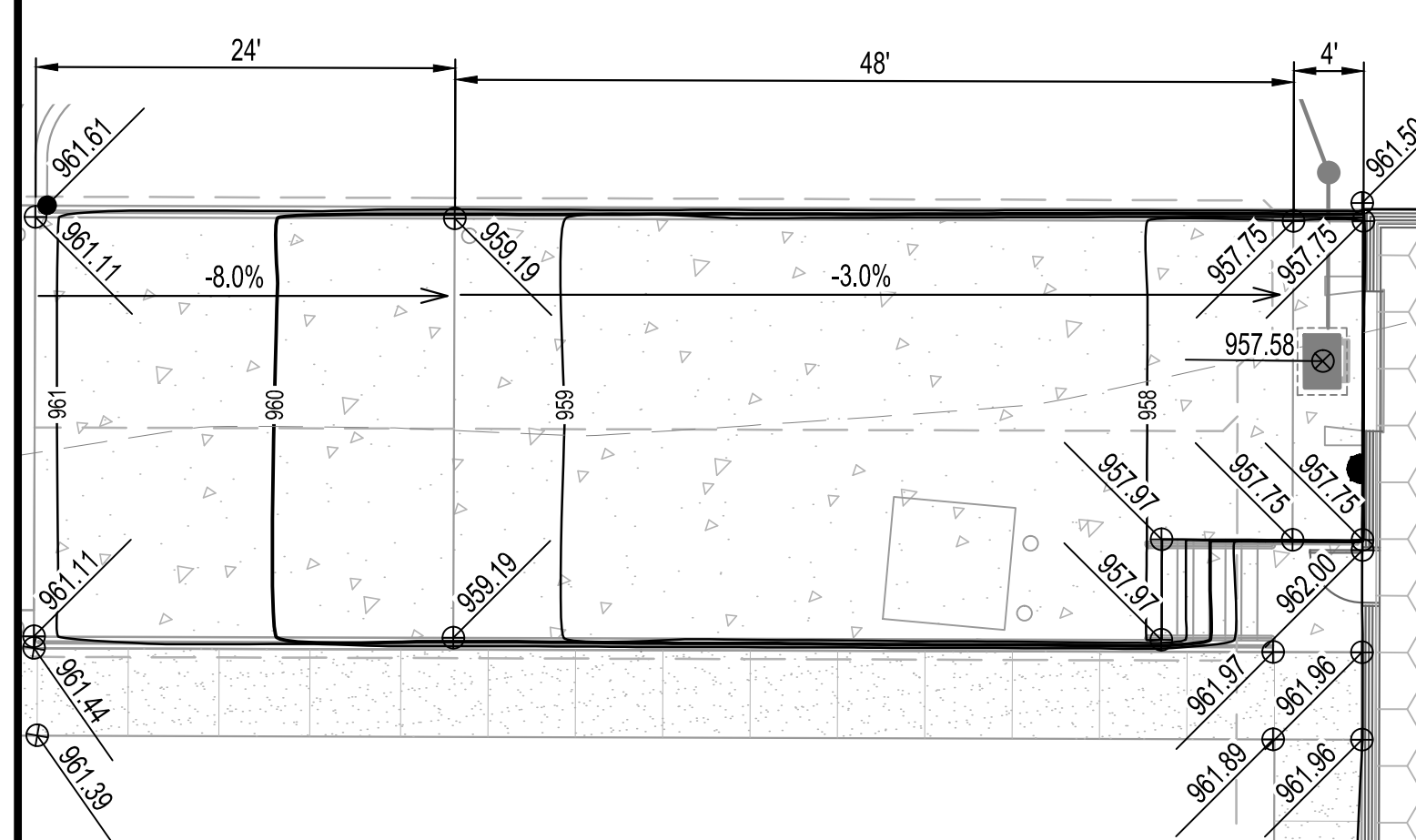
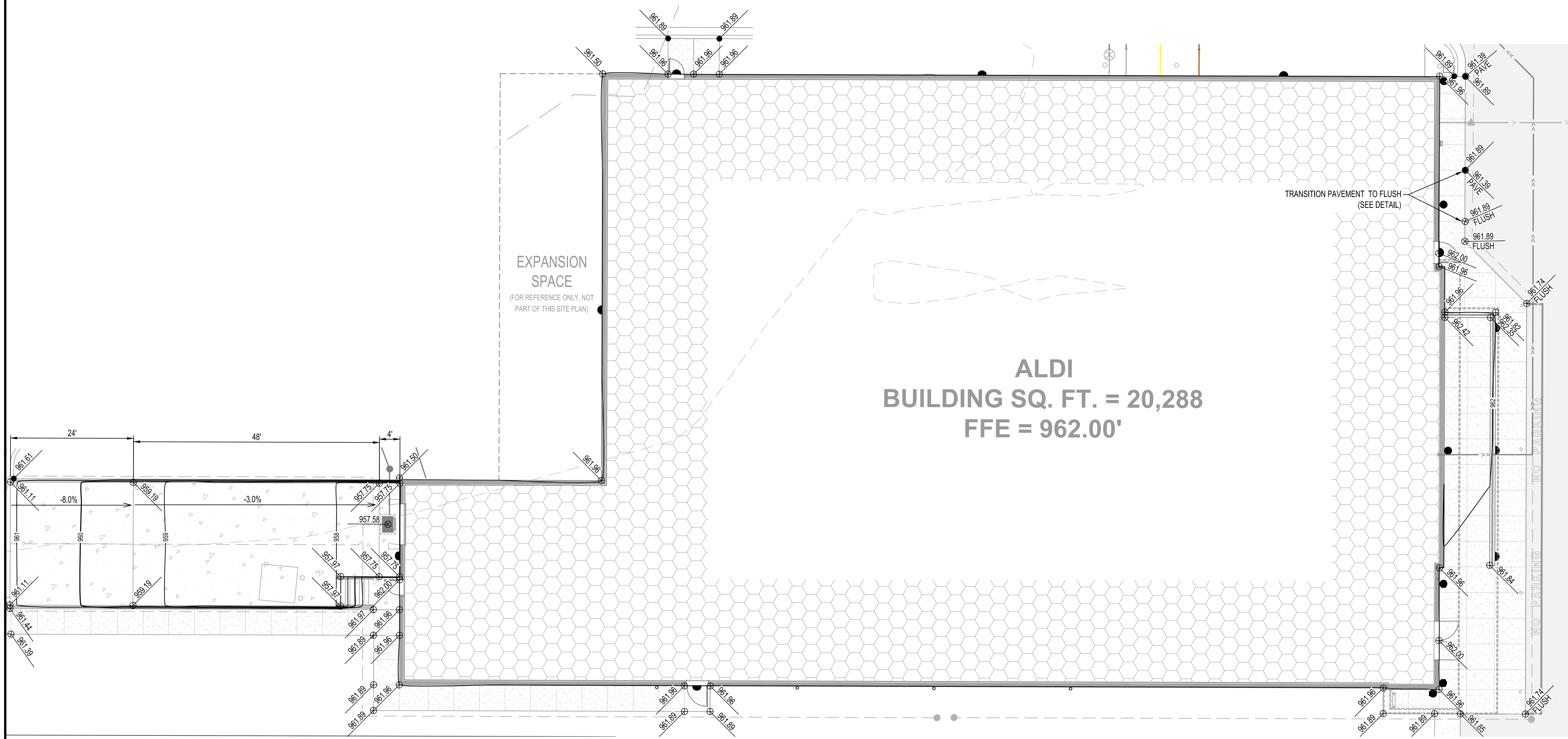

GRADING LEGEND	
--- 101 ---	EXISTING CONTOUR (MINOR INTERVAL)
--- 100 ---	EXISTING CONTOUR (MAJOR INTERVAL)
— 101 —	PROPOSED CONTOUR (MINOR INTERVAL)
— 100 —	PROPOSED CONTOUR (MAJOR INTERVAL)
● 952.0	PROPOSED SPOT ELEVATION
● 952.0	PROPOSED TOP BACK OF CURB SPOT ELEVATION
-X.X%	SURFACE GRADE / DIRECTION

GENERAL GRADING NOTES
 PROPOSED CONTOURS SHOW FINISHED GRADE ELEVATIONS. BUILDING PAD AND PAVEMENT HOLD DOWNS ARE NOT INCLUDED.

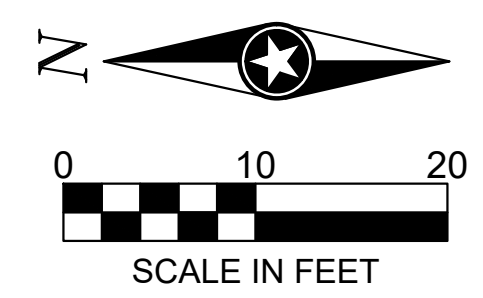

MANAGING LOCATION:
MINNEAPOLIS / ST. PAUL OFFICE
 7900 INTERNATIONAL DRIVE
 INTERNATIONAL PLAZA, SUITE 550
 MINNEAPOLIS, MN 55425
 PHONE: 952.426.0699

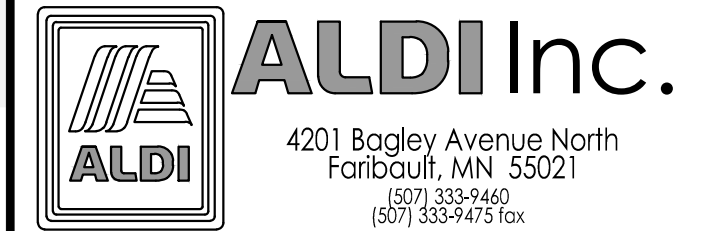

ALDI Inc. Store #: 64
 CEDAR FALLS, IA
 219 BRANDILYNN BLVD
 CEDAR FALLS, IA 50613
 BLACKHAWK COUNTY
 Project Name & Location:

BUILDING GRADING PLAN
 Drawing Name:
 Type: V7.0 ER
 Drawn By: JMF
 Designed By: JMF
 Reviewed By: RJA
 ISG Project No.
 16-19997
 C-420
 Drawing No.

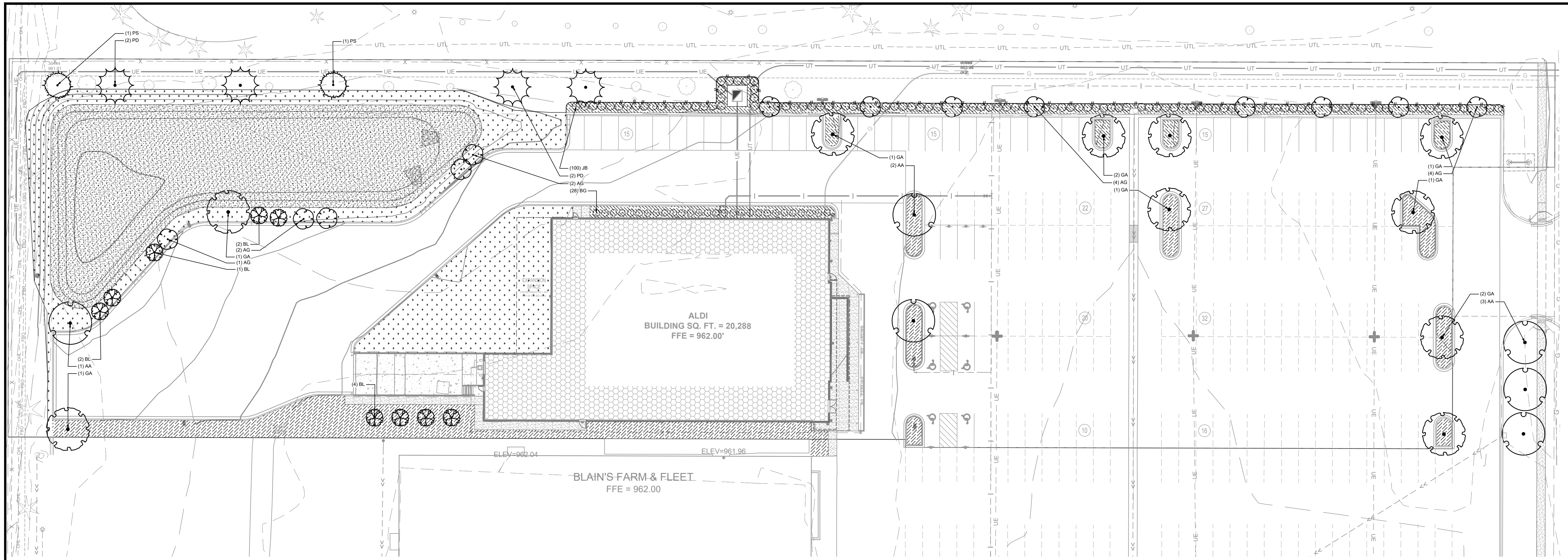

Issued:		Date:
A	SITE PLAN SUBMITTAL	02/19/21
B	PERMIT SET	03/19/21
C	BID SET	04/05/21
D		
E		

Revisions:		Date:
1		
2		
3		
4		
5		
6		
7		
8		
9		

PLANT SCHEDULE					
EVERGREEN TREES	CODE	QTY	BOTANICAL / COMMON NAME	SIZE	ROOT
	PD	4	PICEA GLAUCA 'DENSATA' BLACK HILLS SPRUCE	6' HT MIN	B & B
	PS	2	PINUS STROBUS WHITE PINE	6' HT MIN	B & B
OVERSTORY TREES	CODE	QTY	BOTANICAL / COMMON NAME	SIZE	ROOT
	AA	6	ACER X FREEMANII 'JEFFSRED' TM AUTUMN BLAZE FREEMAN MAPLE	2" CAL	B & B
	GA	10	GINKGO BILOBA 'AUTUMN GOLD' TM AUTUMN GOLD MAIDENHAIR TREE	2" CAL	B & B
UNDERSTORY TREES	CODE	QTY	BOTANICAL / COMMON NAME	SIZE	ROOT
	AG	13	AMELANCHIER X GRANDIFLORA 'AUTUMN BRILLIANCE' AUTUMN BRILLIANCE APPLE SERVICEBERRY	2" CAL	B & B
	BL	9	BETULA NIGRA 'LITTLE KING' TM FOX VALLEY DWARF RIVER BIRCH	2" CAL	B & B
EVERGREEN SHRUBS	CODE	QTY	BOTANICAL / COMMON NAME	SIZE	ROOT
	BG	28	BUXUS X 'GLENCOE' TM CHICAGOLAND GREEN BOXWEED	5 GAL	CONT
	JB	100	JUNIPERUS CHINENSIS 'DAUB'S FROSTED' DAUB'S FROSTED JUNIPER	5 GAL	CONT

PREFERENCE NOTES SCHEDULES		
EDGER	QTY	DESCRIPTION
	588 LF	POLYEDGER
GROUND COVERS	QTY	DESCRIPTION
	17,824 SF	DRY DETENTION BASIN SEED MIX (PRAIRIE MOON NURSERY)
	12,382 SF	ROCK MULCH 2" DIA RIVER ROCK AT 3" DEPTH
	13,737 SF	TURF SOD MIX (IADOT APPROVED MIXES)

HWY-1 HIGHWAY COMMERCIAL DISTRICT LANDSCAPE REQUIREMENTS:

SITE AREA POINTS
 .02 Points / 1 SF (188,756 x .02) = 3,775 Points Requirements
 (6 Trees x 80 Points) = 480 Points (6' HT Trees Proposed)
 (2 Existing Trees x 100 Points) = 200 Points (10' HT or Greater Conifer Trees)
 (3 Trees x 80 Points) = 240 Points (2" CAL Overstory Trees)
 (22 Trees x 40 Points) = 880 Points (2" CAL Understory Trees)
 (7 Existing Trees x 100 Points) = 700 Points (4" CAL or Greater Overstory Trees)
 (126 Shrubs x 10 Points) = 1,260 Points (5 Gallon Shrubs)
 Total Site Area Points = 3,780 Points Proposed

STREET FRONTAGE POINTS
 .75 Points / 1 LF (220 x .75) = 165 Points Required
 (3 Trees x 80 Points) = 240 Points (2" CAL Understory)
 Total Street Frontage Points = 240 Points Proposed

PARKING TREES REQUIRED
 10 Overstory Trees / 15 Parking Stalls (185 / 15) = (12) 2" CAL Trees
 Less (2) Existing Site Trees = (1) 2" CAL Overstory Tree
 Total Parking Lot Trees = 12 Trees Proposed

**FOR INFORMATION ON IRRIGATION
SEE DETAIL SHEET**

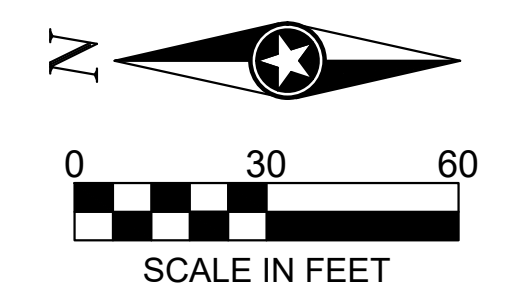

MANAGING LOCATION:
MINNEAPOLIS / ST. PAUL OFFICE
 7900 INTERNATIONAL DRIVE
 INTERNATIONAL PLAZA, SUITE 550
 MINNEAPOLIS, MN 55425
 PHONE: 952.426.0699

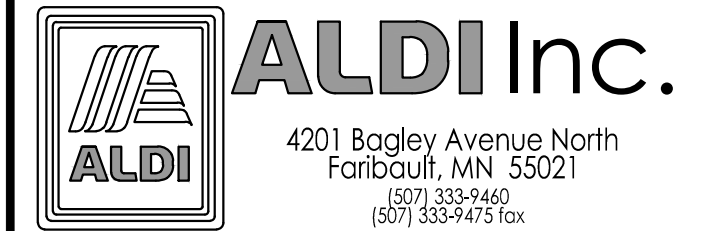

ALDI Inc. Store #: 64
CEDAR FALLS, IA
 219 BRANDILYNN BLVD
 CEDAR FALLS, IA 50613
 BLACKHAWK COUNTY
 Project Name & Location:

SITE RESTORATION & PLANTING PLAN	
Drawing Name:	ISG Project No.
Type: V7.0 ER	16-19997
Drawn By: JMF	
Designed By: JMF	C-510
Reviewed By: RJA	Drawing No.

Issued:	Date:
A SITE PLAN SUBMITTAL	02/19/21
B PERMIT SET	03/19/21
C BID SET	04/05/21
D	
E	
Revisions:	Date:
1	
2	
3	
4	
5	
6	
7	
8	
9	

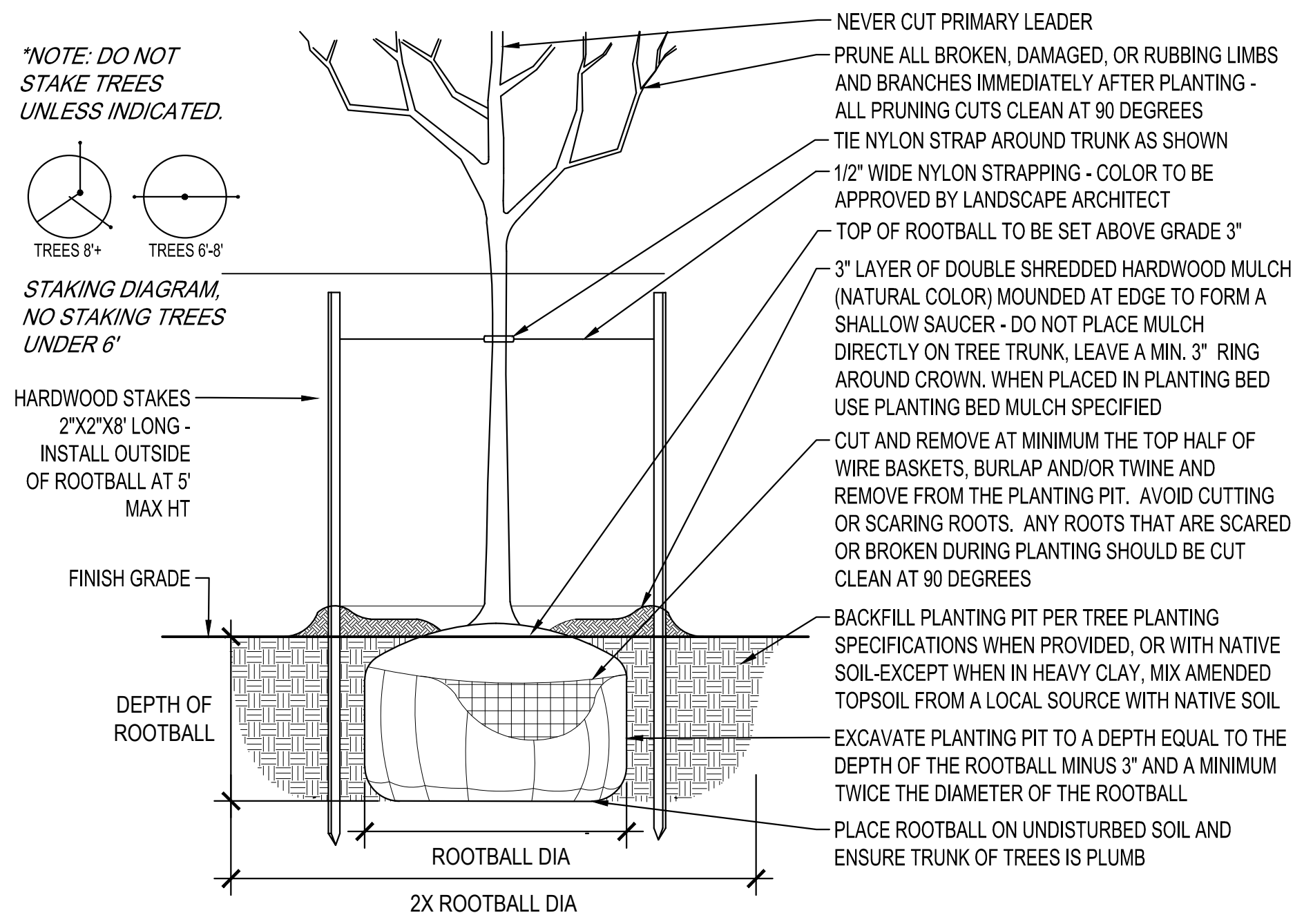

DECIDUOUS TREE PLANTING DETAIL
SCALE: 1" = 1'-0

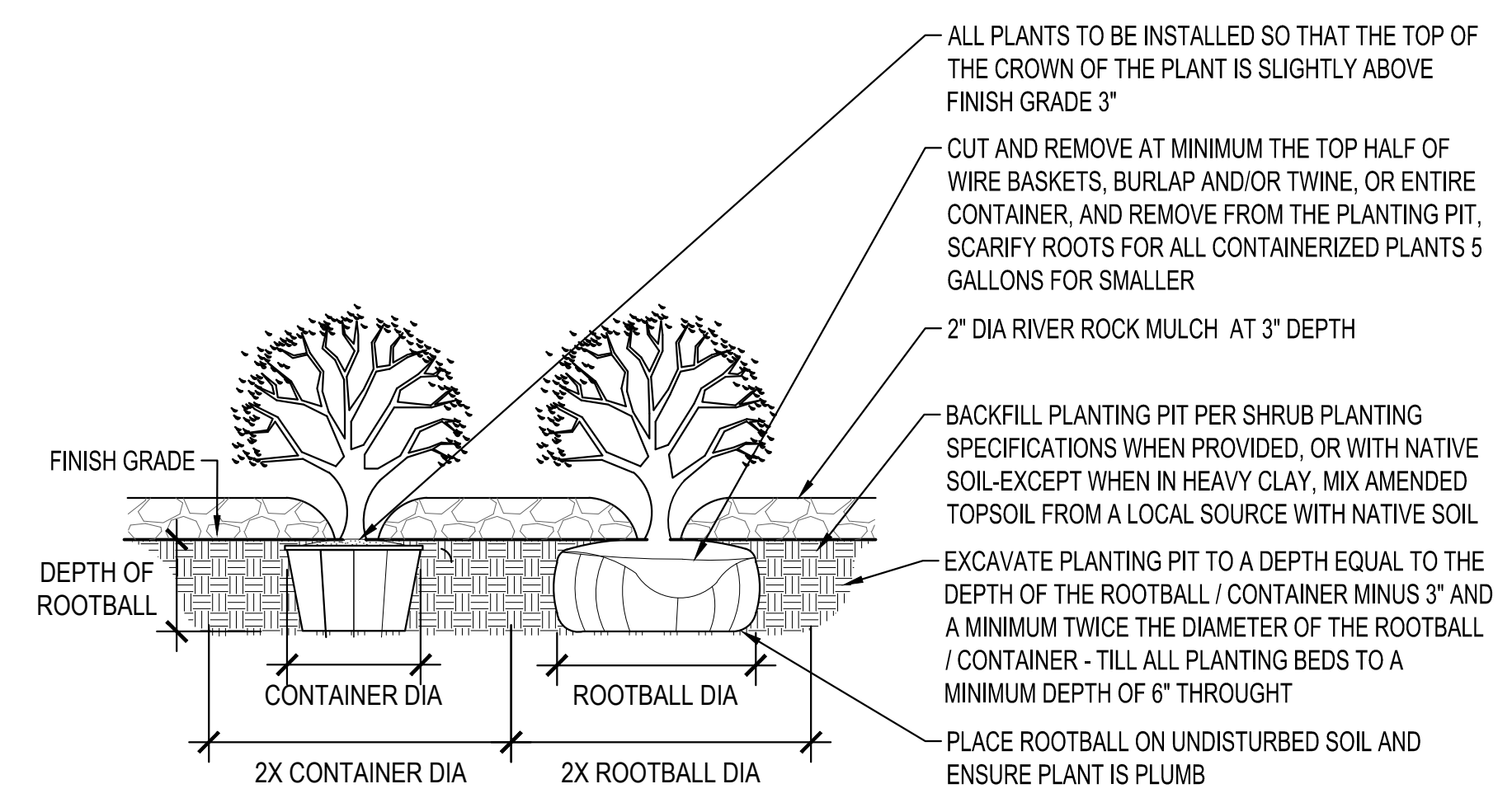

SHRUB PLANTING DETAIL
SCALE: 1" = 1'-0

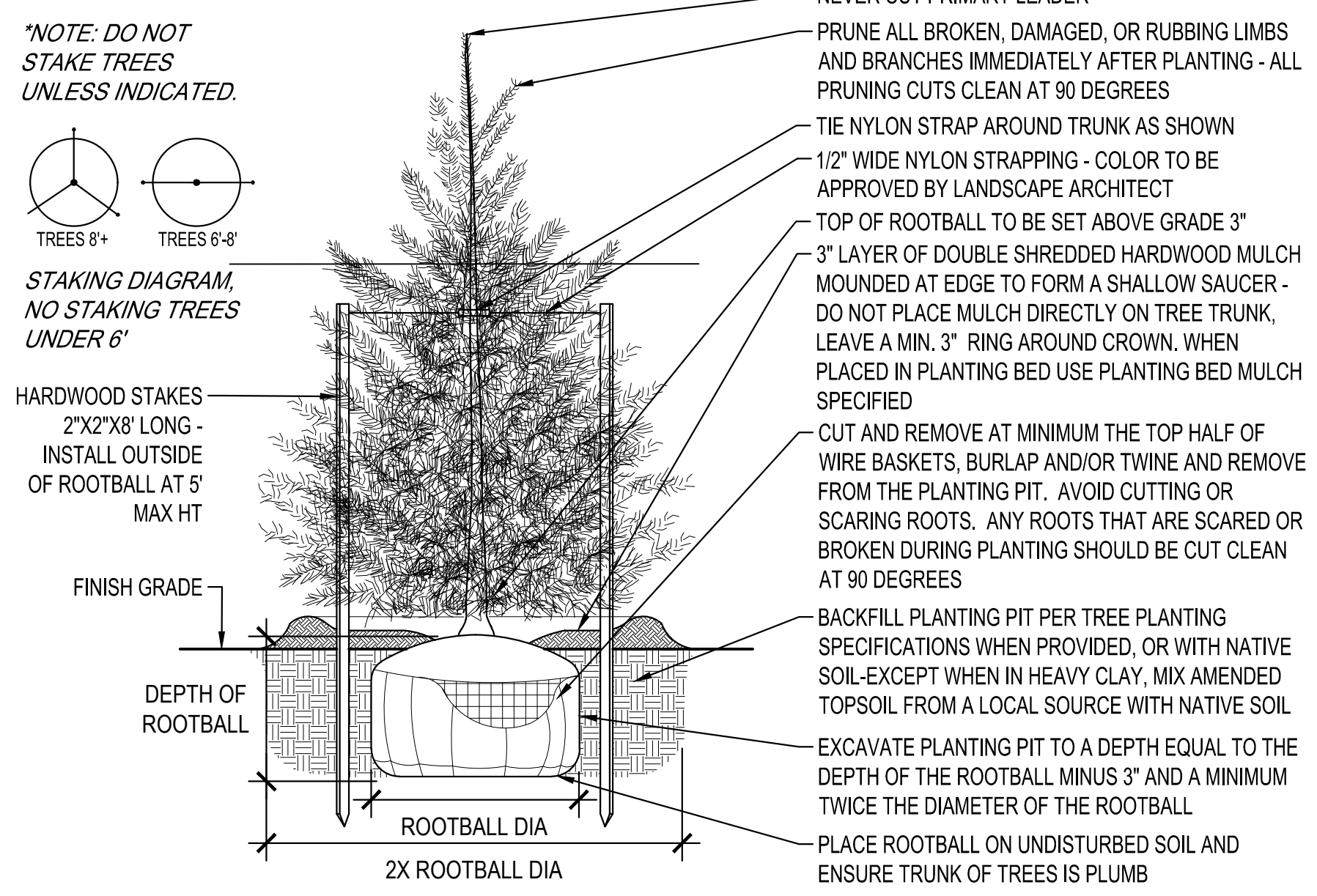

CONIFER / EVERGREEN TREE PLANTING DETAIL
SCALE: 1" = 1'-0

GENERAL PLANTING NOTES

- COORDINATE LOCATION OF ALL UTILITIES (LINES, DUCTS, CONDUITS, SLEEVES, FOOTINGS, ETC.) WITH LOCATIONS OF PROPOSED LANDSCAPE ELEMENTS . CONTRACTOR SHALL REPORT ANY DISCREPANCIES TO OWNER'S REPRESENTATIVE PRIOR TO WORK.
- SAVE AND PROTECT ALL EXISTING TREES NOT NOTED TO BE REMOVED.
- REMOVE ALL CONSTRUCTION DEBRIS AND MATERIALS INJURIOUS TO PLANT GROWTH FROM PLANTING PITS AND BEDS PRIOR TO BACKFILLING WITH PLANTING MIX.
- ANY AREAS OUTSIDE THE LIMIT OF WORK THAT ARE DISTURBED SHALL BE RESTORED TO ITS ORIGINAL CONDITION AT NO ADDITIONAL COST TO OWNER.
- LAWN AREAS SHALL HAVE 4" MINIMUM DEPTH OF TOPSOIL. TOPSOIL SHALL BE COMPACTED TO 85% MAXIMUM DENSITY AT OPTIMUM MOISTURE CONTENT.
- REFER TO PLANTING DETAILS PLAN FOR AMENDED SOIL DEPTH IN PLANTING BEDS AND SURROUNDING TREES. REFER TO SPECIFICATIONS FOR MIX TYPE.
- FIELD STAKE PLANTINGS ACCORDING TO PLAN. OWNER'S REPRESENTATIVE SHALL APPROVE ALL PLANT LOCATIONS PRIOR TO INSTALLATION. OWNER RESERVES THE RIGHT TO REVISE PLANTING LAYOUT AT TIME OF INSTALLATION.
- ALL PLANT MATERIALS SHALL BE TRUE TO THEIR SCIENTIFIC NAME AND SIZE AS INDICATED IN THE PLANT SCHEDULE.
- IF DISCREPANCIES EXIST BETWEEN THE NUMBER OF PLANTS DRAWN ON THE PLANTING PLAN AND THE NUMBER OF PLANTS IN THE SCHEDULE, THE PLANTING PLAN SHALL GOVERN.
- OWNER RESERVES THE RIGHT TO REVISE QUANTITIES TO SUIT BUDGET LIMITATIONS. CONTRACTOR'S UNIT BID PRICES SHALL PREVAIL FOR ANY CHANGES IN QUANTITIES.
- ANY PROPOSED SUBSTITUTIONS OF PLANT SPECIES SHALL BE MADE WITH PLANTS OF EQUIVALENT OVERALL FORM, HEIGHT, BRANCHING HABIT, FLOWER, LEAF, COLOR, FRUIT AND CULTURE, AND ONLY AFTER WRITTEN APPROVAL OF THE OWNER'S REPRESENTATIVE AND OWNER.
- ALL PLANT MATERIALS MUST CONFORM TO AMERICAN STANDARDS FOR NURSERY STOCK (A.N.S.I.), LATEST EDITION PUBLISHED BY THE AMERICAN ASSOCIATION OF NURSERYMEN, WASHINGTON D.C. LARGER SIZED PLANT MATERIALS OF THE SPECIES LISTED MAY BE USED IF THE STOCK CONFORMS TO A.N.S.I.
- ALL PLANT MATERIAL SHALL BE GUARANTEED TO BE IN A LIVE AND HEALTHY GROWING CONDITION FOR ONE FULL GROWING SEASON (ONE YEAR) AFTER FINAL PROJECT ACCEPTANCE OR SHALL BE REPLACED FREE OF CHARGE WITH THE SAME GRADE AND SPECIES. ALL TREES SHALL HAVE A STRONG CENTRAL LEADER.
- PROVIDE 2" DIA RIVER ROCK MULCH AT 3" DEPTH WITH PERMEABLE WEED BARRIER IN ALL PLANTING BEDS, AND MAINTENANCE STRIP AREAS. FOR TREES NOT LOCATED IN PARKING ISLANDS, OR PLANTING BEDS, PROVIDE DOUBLE SHREDDED HARDWOOD MULCH RING (NATURAL COLOR) AT 3" DEPTH PER PLANTING DETAILS.
- ALL AREAS DISTURBED BY CONSTRUCTION TO BE SODED.

IRRIGATION NOTES

- IRRIGATION SYSTEM SHALL BE CONSTRUCTED AS A DESIGN BUILD PROJECT. SUBMIT DESIGN DRAWINGS FOR APPROVAL BY OWNER.
- ONLY PLANTING BEDS AND TURF AREAS AS SHOWN ON IRRIGATION LIMITS SHALL BE SERVICED BY THE IRRIGATION SYSTEM. ALL IRRIGATION SHALL BE COMPATIBLE WITH LOCAL JURISDICTION CODE. IRRIGATION SHALL NOT OVER SPRAY ONTO ADJACENT HARDSCAPE, BUILDINGS, OR ANY OTHER NON-TURF AREAS.
- PROVIDE ALL IRRIGATION LINE, SPRAY HEADS, SLEEVING UNDER HARDSCAPE, VALVES, WIRING, CONTROLLER, BACK-FLOW PREVENTOR, MAIN & LATER PIPES, CENTRAL CONTROL WATER MANAGEMENT SYSTEM, AND ALL OTHER REQUIRED ACCESSORIES.
- CONFIRM POINT(S) OF CONNECTION AND CONTROL BOX LOCATIONS WITH OWNER PRIOR TO DESIGN OF IRRIGATION SYSTEM. COORDINATE LOCATIONS OF SLEEVING WITH ALL UTILITIES, FOOTINGS, AND ANY OTHER UNDERGROUND CONSTRUCTION.
- IRRIGATION WATER METER TO BE INSTALLED BY PLUMBING CONTRACTOR.

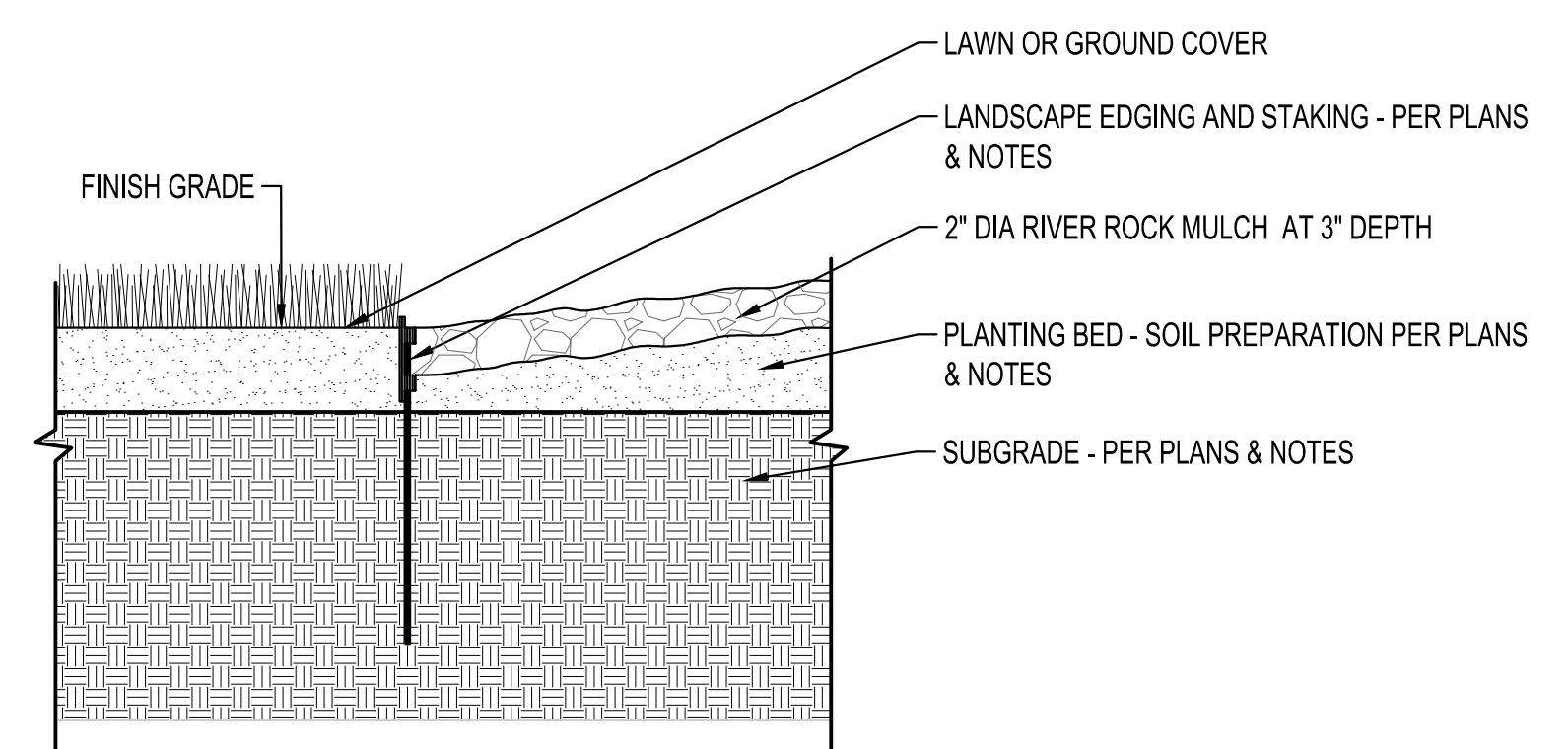

LANDSCAPE EDGING DETAIL
SCALE: 1" = 1'-0



MANAGING LOCATION:
MINNEAPOLIS / ST. PAUL OFFICE
7900 INTERNATIONAL DRIVE
INTERNATIONAL PLAZA, SUITE 550
MINNEAPOLIS, MN 55425
PHONE: 952.426.0699

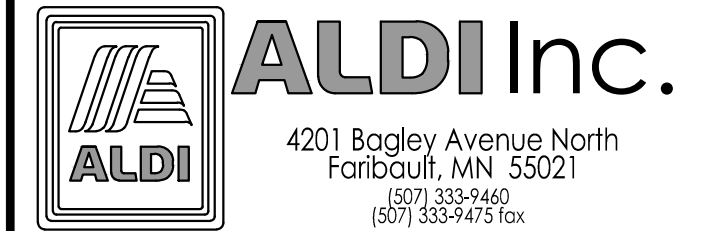

ALDI Inc. Store #: 64
CEDAR FALLS, IA
219 BRANDILYNN BLVD
CEDAR FALLS, IA 50613
BLACKHAWK COUNTY
Project Name & Location:

SITE PLANTING NOTES & DETAILS

Drawing Name:	ISG Project No.
Type: V7.0 ER	16-19997
Drawn By: JMF	
Designed By: JMF	C-520
Reviewed By: RJA	Drawing No.

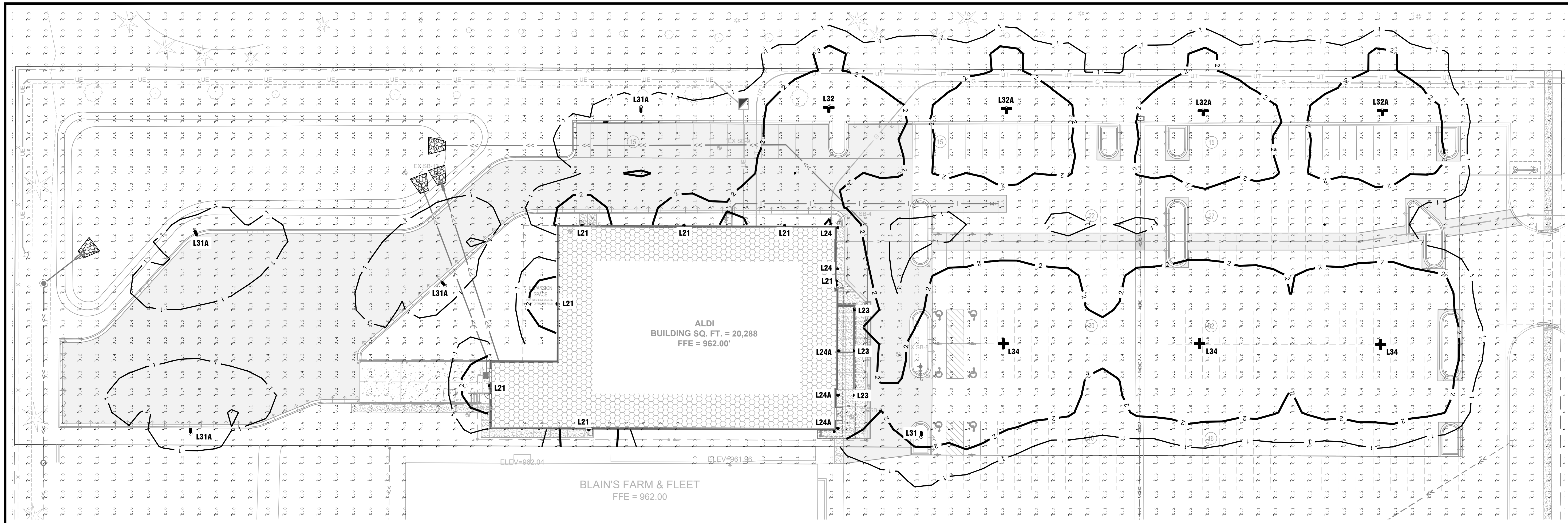

Issued:		Date:
A	SITE PLAN SUBMITTAL	02/19/21
B	PERMIT SET	03/19/21
C	BID SET	04/05/21
D		
E		
Revisions:		Date:
1	ADDENDUM 1	04/16/21
2		
3		
4		
5		
6		
7		
8		
9		



"L21" LIGHT STYLE



"L23" LIGHT STYLE



"L24" & "L24A" LIGHT STYLE



"L31", "L31A", "L32", "L32A", & "L34" LIGHT STYLE

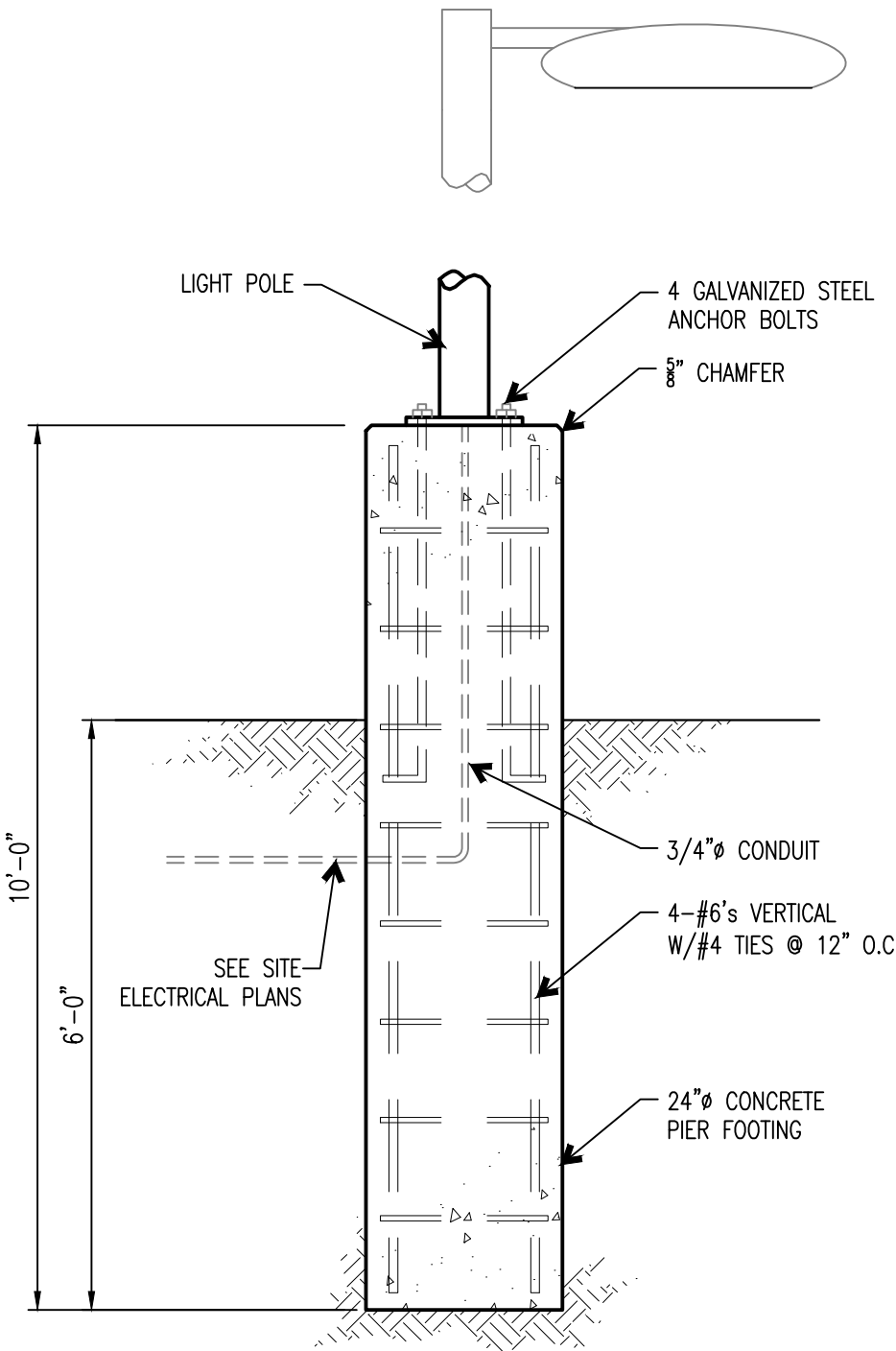

1 LIGHT POLE DETAIL
N.T.S.

Provide light fixtures as shown on Fixture Schedule. Substitutions shall have prior approval by the Project Engineer before bid date. Being listed as an acceptable Manufacturer in no way relieves the Contractors obligation to provide all equipment and features in accordance with these specifications.

LIGHT FIXTURE SCHEDULE

TYPE	STYLE	MANUFACTURER/MODEL NUMBER	LAMPS	REMARKS
L21	BUILDING MOUNTED WALL PACK	CREE LIGHTING #XSPW-B-WM-3ME-4L-30K-UL-SV-P	LED	MOUNT FIXTURE AT 12'-0" ABOVE FINISHED FLOOR
L23	DECORATIVE WALL SCONCES	CREE LIGHTING #AL-42WLED-JUD-CG-120-30K	LED	MOUNT FIXTURE AT 8'-0" ABOVE FINISHED FLOOR
L24	ACCENT CYLINDER	CREE LIGHTING #CL-20364LEDD-SAT-CLR-SB	LED	MOUNT FIXTURE AT 10'-6" ABOVE FINISHED FLOOR
L24A	ACCENT CYLINDER	CREE LIGHTING #CL-20364LEDD-SAT-CLR-SB	LED	MOUNT FIXTURE AT 17'-2" ABOVE FINISHED FLOOR
L31	SITE POLE SINGLE HEAD @ 90 POLE	CREE LIGHTING #OSO-A-NM-4ME-8-57K-UL-SV, w/OSO-DA-SV CREE LIGHTING #SSS-4-11-25-CW-BS-1D-C-SV	LED	1@90 FIXED ARM MOUNT 25'-0" POLE
L31A	SITE POLE SINGLE HEAD @ 90 POLE	CREE LIGHTING #OSO-A-NM-2ME-8-57K-UL-SV, w/OSO-DA-SV, w/OSO-BLSMF CREE LIGHTING #SSS-4-11-25-CW-BS-1D-C-SV	LED	1@90 FIXED ARM MOUNT 25'-0" POLE
L32	SITE POLE TRIPLE HEAD @ 90 POLE	CREE LIGHTING #OSO-A-NM-4ME-8-57K-UL-SV, w/OSO-DA-SV, w/OSO-BLSMF CREE LIGHTING #SSS-4-11-25-CW-BS-3D90-C-SV	LED	3@90 FIXED ARM MOUNT 25'-0" POLE
L32A	SITE POLE TRIPLE HEAD @ 90 POLE	CREE LIGHTING #OSO-A-NM-4ME-8-57K-UL-SV, w/OSO-DA-SV, w/OSO-BLSMF CREE LIGHTING #SSS-4-11-25-CW-BS-3D90-C-SV	LED	3@90 FIXED ARM MOUNT 25'-0" POLE ON EXISTING BASE
L34	SITE POLE QUAD HEAD @ 90 POLE	CREE LIGHTING #OSO-A-NM-4ME-8-57K-UL-SV, w/OSO-DA-SV CREE LIGHTING #SSS-4-11-25-CW-BS-4D90-C-SV	LED	4@90 FIXED ARM MOUNT 25'-0" POLE ON EXISTING BASE

NOTE: CONTRACTOR TO DISCONNECT LIGHTS ON ALDI PROPERTY FROM THE BLAIN'S CIRCUIT AND REFEED THE LIGHTS TO ALDI. SEE SITE ELECTRICAL PLANS FOR DESIGN.

FOOTCANDLE LEGEND

1.00 FOOTCANDLE LINE	1
2.00 FOOTCANDLE LINE	2

NOTE: SEE ELECTRICAL PLAN FOR SITE ELECTRICAL LAYOUT

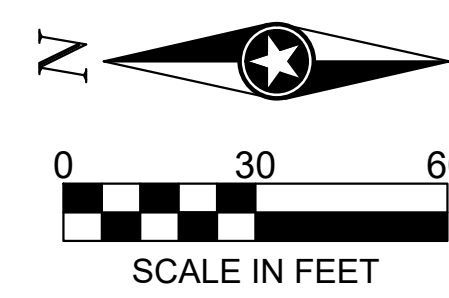

MANAGING LOCATION:
MINNEAPOLIS / ST. PAUL OFFICE
7900 INTERNATIONAL DRIVE
INTERNATIONAL PLAZA, SUITE 550
MINNEAPOLIS, MN 55425
PHONE: 952.426.0699

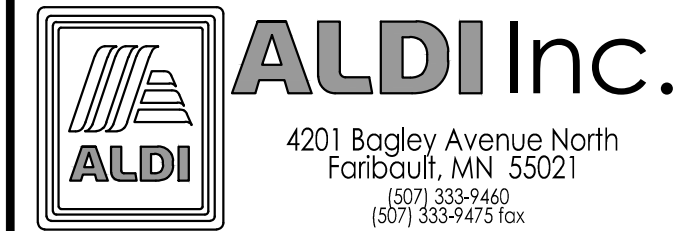

ALDI Inc. Store #: 64
CEDAR FALLS, IA
219 BRANDILYNN BLVD
CEDAR FALLS, IA 50613
BLACKHAWK COUNTY

Project Name & Location:

SITE LIGHTING PHOTOMETRICS PLAN

Drawing Name:	ISG Project No.
Type: V7.0 ER	16-19997
Drawn By: JMF	C-610
Designed By: JMF	Drawing No.
Reviewed By: RJA	

Issued:		Date:
A	SITE PLAN SUBMITTAL	02/19/21
B	PERMIT SET	03/19/21
C	BID SET	04/05/21
D		
E		
Revisions:		Date:
1		
2		
3		
4		
5		
6		
7		
8		
9		

XSP Series

XSPW™ LED Wall Mount Luminaire featuring Cree TrueWhite® Technology

Product Description
The XSPW™ LED wall mount luminaire has a slim, low profile design intended for outdoor wall mounted applications. The rugged lightweight aluminum housing and mounting base are designed for installation over standard single gang J-Boxes and mud ring single gang J-Boxes. The luminaire allows for through-wired or conduit entry from the top, bottom, sides and rear. The housing design is intended specifically for LED technology including a weatheright LED driver compartment and thermal management. Optic design features industry-leading NanoOptic® Precision Delivery Grid™ system in multiple distributions.

Applications: General area and security lighting

Performance Summary

NanoOptic® Precision Delivery Grid™ optic
Assembled in the U.S.A. of U.S. and imported parts
CRI: Minimum 70 CRI (3000K, 4000K & 5700K); 90 CRI (5000K)
CCT: 3000K, 4000K, 5000K, 5700K
Limited Warranty: 10 years on luminaire/10 years on Colorfast DeltaGuard® finish

Accessories

Field-Installed

Steady Plug
WM-FL12™ - 12" (305mm) Square
WM-FL14™ - 14" (355mm) Square
- Covers holes left by mount/best wall packs

Hand-Held Remote
XA SENSREM
- For successful implementation of the programmable multi-level option, a minimum of one hand-held remote is required

Ordering Information
Example: XSPW-B-WM-2ME-2L-30K-UL-BK

Product	Version	Mounting	Optic	Lumen Package*	CCT	Voltage	Color Options	Options
XSPW	B	WM	2ME Type II Medium	2L 2,470 lumens - 70 CRI	30K	UL Universal 120-277V	BK Black	ML Multi-Level - Refer to ML spec sheet for details - Available with UL voltage only
			2ME Type III Medium	4L 4,270 lumens - 70 CRI	40K	UL Universal 347-480V	BZ Bronze	P Button Photocell - Not available with ML or PML options
			2ME Type IV Medium	6L 6,100 lumens - 90 CRI	60K	UL Universal 347-480V	SV Silver	PM Programmable Multi-Level - Refer to PML spec sheet for details - Available with UL voltage only
				8L 8,475 lumens - 90 CRI	80K	UL Universal 347-480V	WH White	
					57K 5700K - 70 CRI			



Lumen Package	Weight
2L, 4L, 6L	11.0 lbs. (5.0kg)
8L	11.8 lbs. (5.4kg)

* Lumen Package selection codes identify approximate light output only. Actual lumen output levels may vary depending on CCT and optic selection. Refer to initial Delivered Lumens tables for specific lumen values

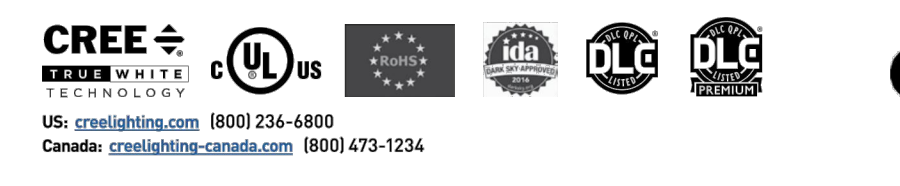

AL Series

EXTERIOR LED Uplight/Downlight Wall Sconce

Product Description
The AL Series exterior LED Uplight/Downlight Wall Sconce is designed for outdoor wall mounted applications. The rugged cast aluminum housing and mounting base are designed for installation over standard single gang J-Boxes and mud ring single gang J-Boxes. The luminaire allows for through-wired or conduit entry from the top, bottom, sides and rear. The housing design is intended specifically for LED technology including a weatheright LED driver compartment and thermal management. Optic design features industry-leading NanoOptic® Precision Delivery Grid™ system in multiple distributions.

Applications: General area and security lighting

Performance Summary

Initial Delivered Lumens: Up to 2,255 lumens
System Watts: 45 watts
CCT: 3000K (+/- 300K), 5700K (+/- 500K) standard
CRI: Minimum 70 CRI (5700K), 80 CRI (3000K)
Input Voltage: 120V
Finish: Bronze, Silver with Gray Band
Construction: Die cast aluminum housing
Dimensions: 14.0"W X 15.0"H X 10.0"D
Compliance: cULus listed, suitable for wet locations
Warranty: 10 year limited warranty. For warranty information, contact factory

Accessories

Field-Installed

Lower Kits
PDRN-LO-BZ
- Bronze lower kit to convert sconce to downlight distribution only
PDRN-LO-SV
- Silver lower kit to convert sconce to downlight distribution only

Ordering Information
Example: AL-4W-LED-U01-100-BZ

Product	Distribution	Voltage	Finish	Option
AL-4W-LED	UD Uplight/Downlight	120 120 Volt	BZ Bronze SV Silver with Gray Band	30K - Minimum 80 CRI - Color temperature per sconce

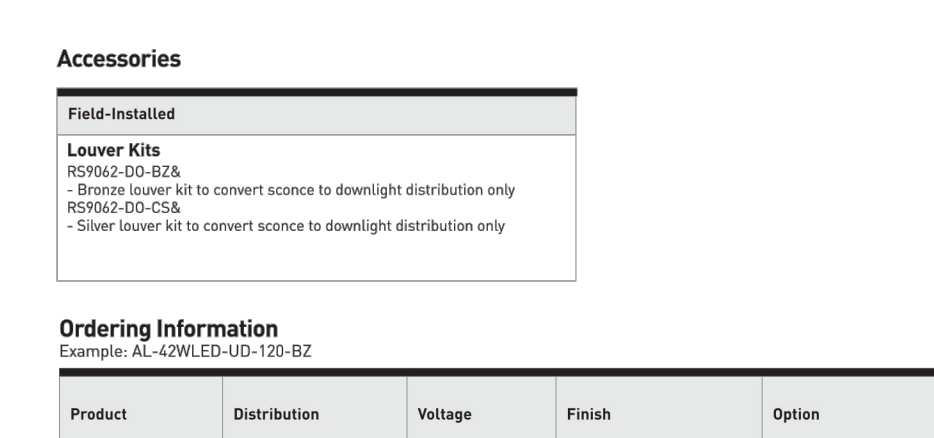

* Lumen Package selection codes identify approximate light output only. Actual lumen output levels may vary depending on CCT and optic selection. Refer to initial Delivered Lumens tables for specific lumen values

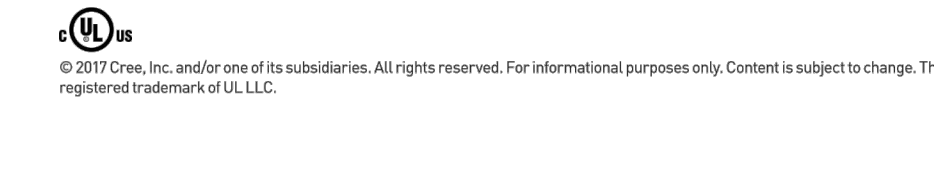

18" Cylinder LED Sconce

Decorative Outdoor - Wall Mount

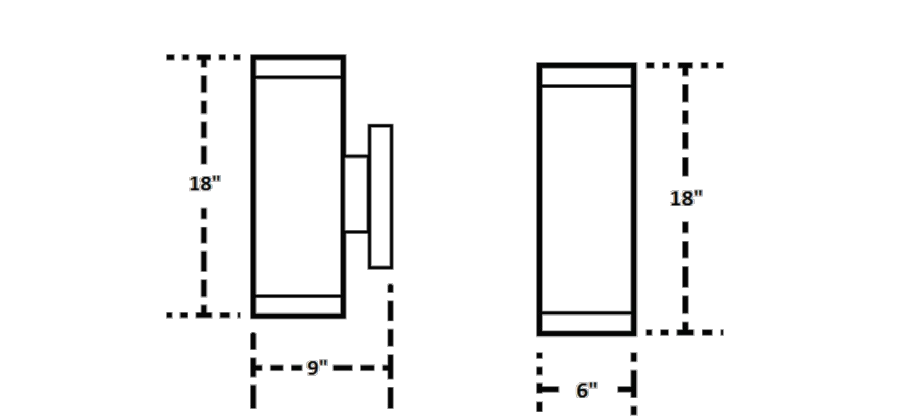

Performance Summary

Distribution: Uplight/Downlight
Initial Delivered Lumens: 2,400
Input Power: 29 watts
CRI: 90+ CRI
CCT: 3000K
Voltage: 120V, 60Hz
Dimmable: Yes*
Finish: Satin
Frame Material: Metal
J-Box Type: 4XA (Standard)
Dimensions: 6.0"W X 18.0"H X 9.0"D
Compliance: ETL, Title 24, and wet location listed when used with top cover
Warranty: Contact factory for warranty information

Accessories

Field-Installed

Top Cover Lens (Included with sconce)
- Adapts up/down sconce for wet location use
- Heat and shatter resistant clear glass lens

Ordering Information
Product
CL-2004LED-SD-SAT-CLR-8R

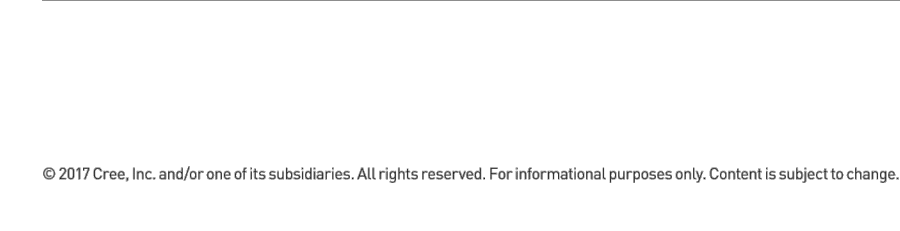

OSQ Series

OSQ™ LED Area/Flood Luminaire featuring Cree TrueWhite® Technology - Medium

Product Description
The OSQ™ Area/Flood luminaire blends extreme optical control, advanced thermal management and modern, clean aesthetics. Built to last, the housing is rugged cast aluminum with an integral, weatheright LED driver compartment. Versatile mounting configurations offer simple installation. Its slim, low-profile design minimizes wind load requirements and blends seamlessly into the site providing even, quality illumination. The 'B' Input power designator is a suitable upgrade for HID applications up to 250 Watt, and the 'K' Input power designator is a suitable upgrade for HID applications up to 400 Watt.

Applications: Parking lots, walkways, campuses, car dealerships, office complexes, tunnels, underpasses, and internal roadways

Performance Summary

Utilizes Cree TrueWhite® Technology on 5000K Luminaires
NanoOptic® Precision Delivery Grid™ optic
Assembled in the U.S.A. of U.S. and imported parts
Initial Delivered Lumens: Up to 17,291
Efficacy: Up to 136 LPW
CRI: Minimum 70 CRI (3000K, 4000K & 5700K); 90 CRI (5000K)
CCT: 3000K, 4000K, 5000K, 5700K
Limited Warranty: 10 years on luminaire; 10 years on Colorfast DeltaGuard® finish; up to 5 years for Synapse® accessories; 1 year on luminaire accessories

Ordering Information
Fully assembled luminaire is composed of two components that must be ordered separately.
Example: Mount: OSQ-B-A02V • Luminaire: OSQ-A-NM-2ME-S-40K-UL-SV

Mount Luminaire must be ordered separately*	Color Options:
OSQ-B-A4 Adjustable Arm OSQ-DA Dimm. Arm OSQ-K-TP Transposition Mount (Stainless steel, do not specify color) OSQ-TM Translum Mount	SV Silver BK Black WH White

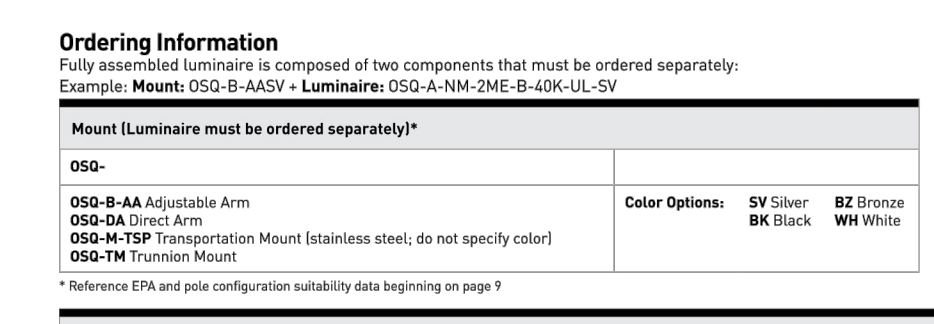

* Reference EPA and psd configuration suitability data beginning on page 9

Product	Version	Mounting	Optic	Input Power Designator	CCT	Voltage	Color Options	Options
OSQ	A	NM	Asymmetric 2ME* Type II Medium 3ME* Type III Medium 4ME* Type IV Medium	B 80W K 100W Z 50W	30K 3000K 40K 4000K 57K 5700K 70 CRI	UL Universal 120-277V UH Universal 347-480V K Available with B & K Input Power Designators only	BK Black BZ Bronze SV Silver WH White	PML Programmable Multi-Level, up to 42" Mounting Height - Refer to PML spec sheet for details - Intended for downlight applications at 0° tilt PML2 Programmable Multi-Level, 10-30" Mounting Height - Refer to PML2 spec sheet for details - Intended for downlight applications at 0° tilt DT/DA/DO/DS/DS2/D1 - Field select DT, DL, DL, DL, DL, DL, or D1 - Offers full range adjustability - Refer to pages 11-12 for power and lumen values - Available with B & K Input Power Designators only - Not available with PML or PML2 options NEMA* 7-Pin Photocell Receptacle - 7-pin receptacle per ANSI C136.41 - Intended for downlight applications with maximum 45° tilt - Factory connected 0-10V dim heads - 18" (457mm) seven-conductor cord with luminaire - Requires photocell or shunting cap by others Rotate Left - LED and optic are rotated to the left - Refer to RR/RL configuration diagram on page 13 for optic directionality Rotate Right - LED and optic are rotated to the right - Refer to RR/RL configuration diagram on page 13 for optic directionality



MANAGING LOCATION:
MINNEAPOLIS / ST. PAUL OFFICE
7900 INTERNATIONAL DRIVE
INTERNATIONAL PLAZA, SUITE 550
MINNEAPOLIS, MN 55425
PHONE: 952.426.0699



ALDI Inc. Store #: 64
CEDAR FALLS, IA
219 BRANDILYNN BLVD
CEDAR FALLS, IA 50613
BLACKHAWK COUNTY

Project Name & Location:

SIGHT LIGHTING CATALOGUE PAGES

Drawing Name:	ISG Project No.
Type: V7.0 ER	16-19997
Drawn By: JMF	C-620
Designed By: JMF	Drawing No.
Reviewed By: RJA	

EXTERIOR FINISH SCHEDULE			
KEY	MATERIAL / MFG.	COLOR / NO.	NOTES
A1	PREFINISHED METAL COPING	A1 - SILVER - AT HIGH ROOF & CANOPY A1a - PETERSEN ALUM - MUSKET GREY-AT BRICK A1b - PETERSEN ALUM - #CEDAR 397C0290 SPRAY CODE - AT NICHIIHA TOWERS	SEE SPECIFICATIONS APPENDIX 'B'
A2	BASE BID - BRICK 'A' SPEC-BRICK CONCRETE MASONRY VENEER	4WX8HX16L (12W @ CART WALL ONLY) CHESAPEAKE BLEND w/ HOLCIM 'SMITH GRAY' MORTAR ALT: SOLOMON '85X DARK CHOCOLATE'	CONTACT THE CONCRETE PRODUCTS GROUP AT 800-789-0872 FOR ORDERING SEE SPEC FOR ADDITIONAL INFO
A2	ALTERNATE No. 2 - BRICK 'B' QUICK-BRICK CONCRETE MASONRY VENEER	4WX8HX16L (12W @ CART WALL ONLY) MAROUS BLEND w/ HOLCIM 'SMITH GRAY' MORTAR ALT: SOLOMON '85X DARK CHOCOLATE'	CONTACT ECHELON MASONRY AT 800-899-8455 FOR ORDERING SEE SPEC FOR ADDITIONAL INFO
A2	ALTERNATE No. 3 - BRICK 'C' BELDEN BRICK	MODULAR EBONY BLACK BLEND w/ HOLCIM 'SMITH GRAY' MORTAR MORTAR ALT: SOLOMON '85X DARK CHOCOLATE'	CONTACT THE BELDEN BRICK COMPANY AT 330-451-2031 FOR ORDERING SEE SPEC FOR ADDITIONAL INFO
A3	PREFINISHED ALUM. SILL FLASHING	A3 - BRIGHT SILVER A3a - PETERSEN ALUM # CEDAR 397C0290 SPRAY CODE'	SEE SPEC FOR ADDITIONAL INFO
A4	ALUMINUM STOREFRONT SYSTEM	ANODIZED ALUM.	RE: DWG. A602
A5	MEMBRANE ROOFING	GRAY	TOP OF SLOPED ROOF, CANOPY ROOF, AND BACK OF RAISED ROOF PROJECTIONS - SEE SPECIFICATIONS APPENDIX 'B'
A6	METAL SOFFIT PANELS	A6 - SOLID PANELS - BRIGHT SILVER A6a - 1/2 VENTED PANELS - BRIGHT SILVER	RE: DWG. A301-A304
A7	EXTERIOR PAINT	PT-19 / CL-9	RE: DWG. A603
A8	ALUMINUM CURTAIN WALL SYSTEM	ANODIZED ALUMINUM	RE: DWG. A602
A9	ALUMINUM COMPOSITE PANEL	BRIGHT SILVER	PROVIDE PANEL JOINTS AS SHOWN - PROVIDE ONE PIECE TIGHT FIT EXTRUDED MOLDING INSTALLATION SYSTEM WITH CENTER REVEAL TRIM BETWEEN PANELS AND J TRIM AT PANEL EDGES.
A10	NICHIIHA FIBER CEMENT EXTERIOR CLADDING	VINTAGEWOOD 'CEDAR'	PANELS SHALL EXTEND ONTO THE ROOF FOR THE FULL DEPTH OF THE BUMPOUT. CONTACT NICHIIHA AT 770-805-9466 FOR ORDERING. SEE SPEC FOR TRIM REQUIREMENTS AND ADDITIONAL INFO. ALL INCLUDED TRIM ('H', 'J', 'L', CORNER, ETC) TO MATCH FCP
A11	BLRD-2	PT-19 / CL-4	RE: DWG A603
A12	BLRD-4		RE: DWG A603
A13	GUARD RAIL TYPE "A"	GALVANIZED STEEL	RE: DWG B2/A507
A14	GUARD RAIL TYPE "B"	GALVANIZED STEEL	RE: DWG B2/A507
A15	BLRD-3	GALVANIZED	RE: DWG A603
A16	DOCK LEVELER / SEAL AND BUMPERS	LEVELER - FACTORY FINISH / SEAL AND BUMPERS - FACTORY FINISH - BLACK	PROVIDE BRICK BEHIND DOCK SEAL
A17	MASONRY CONTROL JOINT		MAX 20' OC
A18	OVERFLOW SCUPPER	MATCH COPING ABOVE	RE: DWG A2/A507
A19	ARCHITECTURAL CAST STONE	TANNERSTONE: AG-1	SEE SPEC FOR ADDITIONAL INFORMATION - MORTAR COLOR TO MATCH CAST STONE
A20	ALDI TOWER SIGN	BY SIGN VENDOR	7'-11 1/8" w. x 9'-5 1/2" h.; VERIFY SIGN SIZE PRIOR TO FRAMING OPENING SEE DETAIL C1/A504
A21	CRTB	NATURAL	RE: DWG A603 - SEE STRUCTURAL DWGS

EXTERIOR FINISH SCHEDULE			
KEY	MATERIAL / MFG.	COLOR / NO.	NOTES
A22	KNOX BOX	FACTORY FINISH	CONFIRM TYPE AND LOCATION WITH LOCAL FIRE MARSHAL
A23	AUTO DOOR SYSTEM & TRANSOM	ANODIZED ALUMINUM	RE: DWG A601 & A602
A24	ALDI LOGO SIGN	BY SIGN VENDOR	SURFACE MOUNTED SIGN: 15'-2 1/2" W. X 5'-1" H.
A25	8" X 8" PRE-FINISHED ALUM GUTTER	MATCH PREFINISHED METAL COPING	
A26	8" X 8" PRE-FINISHED ALUM DOWNSPOUT	MATCH PREFINISHED METAL COPING	TERMINATE AT CONC. SPLASH BLOCK
A27	ACP H/J TRIM / JOINT COVER		TYPICAL AT EDGES AND BUTT JOINTS OF ACP
A28	NICHIIHA FIBER CEMENT PANEL BASE FLASHING	PETERSEN ALUMINUM - #CEDAR 397C0290 SPRAY CODE'	SEE SPEC FOR ADDITIONAL INFO
A29	NOT USED		
A30	NOT USED		
A31	NICHIIHA CONTROL JOINT WITH "H" CLIP		
A32	NOT USED		
A33	NOT USED		
E1	EXIT DISCHARGE LIGHT	FACTORY FINISH	MOUNT @ 8'-0" A.F.F.
E2	WALL SCONCE	FACTORY FINISH	MOUNT @ 14'-8" A.F.F.; RE: DWG. A111 FOR DIMENSIONS
E3	JUNCTION BOX WITH COVER FOR FUTURE CARD READER		MOUNT CENTERED @ 46" A.F.F., SEE ELEC DWGS
E4	UTILITY METERING & C.T.	FACTORY FINISH	SEE ELECTRICAL DWGS
E5	EXTERIOR WALL PACK	FACTORY FINISH	MAN DOORS - MOUNT @ 9'-0" A.F.F., BREAK ROOM WINDOW @ 10'-0" A.F.F., ALL OTHER LOCATIONS - MOUNT @ 12'-0" A.F.F.
E6	EXTERIOR DUPLEX RECEPTACLE	FACTORY FINISH	MOUNT @ 1'-6" A.F.F. IN 4" SQUARE J-BOX
E7	NOT USED		
F1	FIRE DEPT. CONNECTION	FACTORY FINISH	SEE FIRE PROTECTION DWGS
F2	MOTOR GONG	FACTORY FINISH	SEE FIRE PROTECTION DWGS
P1	HOSE BIB	FACTORY FINISH	SEE PLUMBING DWGS
P2	RPZ DISCHARGE	FACTORY FINISH	SEE PLUMBING DWGS
P3	GAS METER	FACTORY FINISH	SEE PLUMBING DWGS
XX	GLAZING KEY		RE: DWG A602
XX	ALIGN KEY		A: ALIGN NICHIIHA PANEL JOINTS AND WINDOW MULLIONS B: ALIGN ALUMINUM COMPOSITE PANEL JOINTS AND WINDOW MULLIONS C: ALIGN NICHIIHA PANEL JOINTS, ALUMINUM COMPOSITE PANEL JOINTS, AND WINDOW MULLIONS

Issued:	Doc. No.
A Issued for Permit	03/19/21
B Issued for Bid	04/05/21
C	
D	
E	
Revisions:	Date:
1	
2	
3	
4	
5	
6	
7	
8	
9	
Seal	Seal
PROJECT ARCHITECT/ENGINEER	DATE
PROJECT LEAD	DATE
PROJECT DESIGNER	DATE
Copyright © 2021 APD Engineering & Architecture, P.L.L.C.	
Drawing Alteration	
It is a violation of law for any person, unless acting under the direction of licensed Architect, Professional Engineer, Landscape Architect, or Land Surveyor to alter any item on this document in any way. Any licensee who alters this document is required by law to affix his or her seal and to add the notation "Altered By:" followed by his or her signature and the specific description of the alteration or revision.	
DO NOT SCALE PLANS	
Copying, Printing, Software and other processes required to produce these prints can stretch or shrink the actual paper or layout. Therefore, scaling of this drawing may be inaccurate. Contact APD & A with any need for additional dimensions or clarifications.	

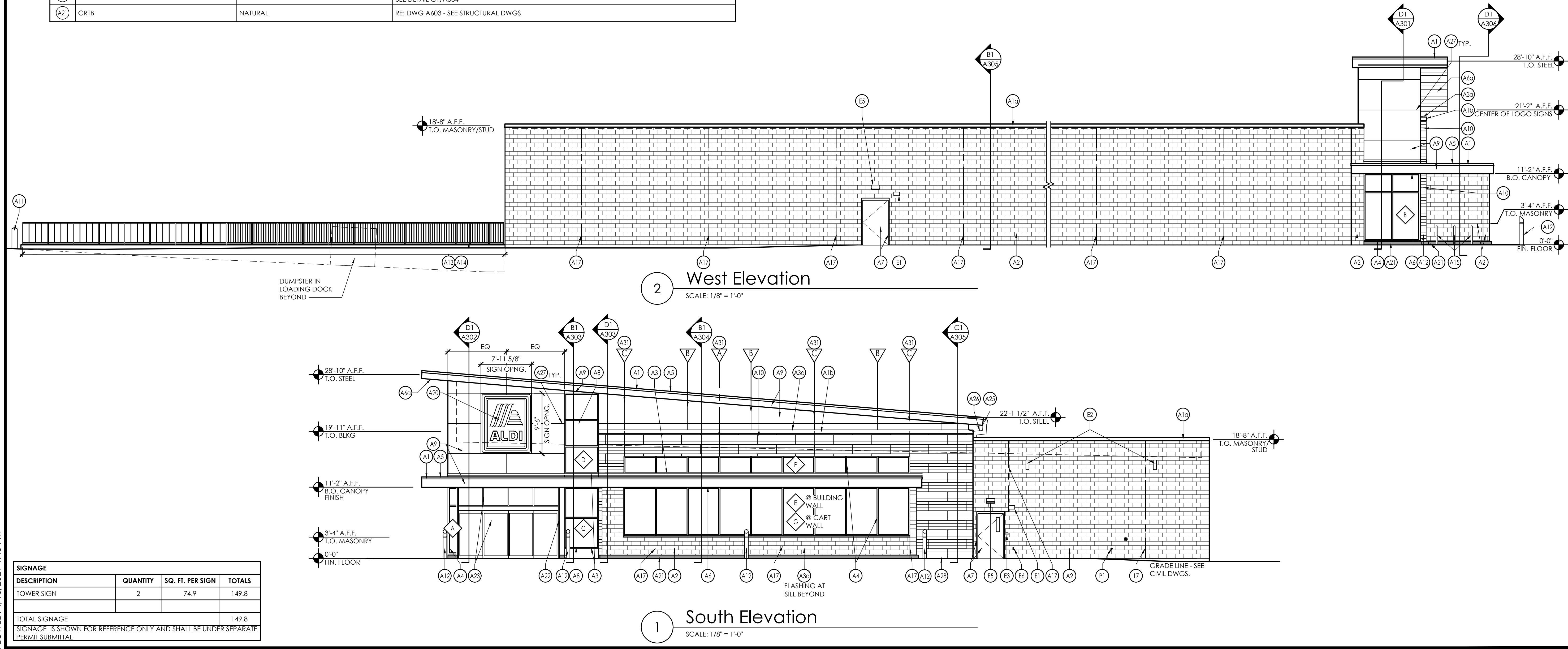

ALDI Inc.
4201 Bagley Avenue North
Faribault, MN 55021
(507) 333-9469
(507) 333-9475 Fax

ALDI Inc. Store #: 64
Cedar Falls, IA
219 Brandilynn Boulevard
Cedar Falls, IA
Black Hawk County
Project Name & Location:

Exterior Elevations
Drawing Name:

Date: 02/25/21
Type: RHSV7ER
Drawn By: CB
Scale: As Noted

Project No.
20-0647B
A-201
Drawing No.

PLOTTED: 4/16/2021 1:43 PM

EXTERIOR FINISH SCHEDULE			
KEY	MATERIAL / MFG.	COLOR / NO.	NOTES
A1	PREFINISHED METAL COPING	A1 - SILVER - AT HIGH ROOF & CANOPY A1a - PETERSEN ALUM - MUSKET GREY-AT BRICK A1b - PETERSEN ALUM - #CEDAR 397C0290 SPRAY CODE - AT NICHIIA TOWERS	SEE SPECIFICATIONS APPENDIX 'B'
A2	BASE BID - BRICK 'A' SPEC-BRICK CONCRETE MASONRY VENEER	4WXBH16L (12W @ CART WALL ONLY) CHESAPEAKE BLEND w/ HOLCIM 'SMITH GRAY' MORTAR ALT: SOLOMON '85X DARK CHOCOLATE'	CONTACT THE CONCRETE PRODUCTS GROUP AT 800-789-0872 FOR ORDERING SEE SPEC FOR ADDITIONAL INFO
A2	ALTERNATE No. 2 - BRICK 'B' QUICK-BRICK CONCRETE MASONRY VENEER	4WXBH16L (12W @ CART WALL ONLY) MAROUS BLEND w/ HOLCIM 'SMITH GRAY' MORTAR ALT: SOLOMON '85X DARK CHOCOLATE'	CONTACT ECHELON MASONRY AT 800-899-8455 FOR ORDERING SEE SPEC FOR ADDITIONAL INFO
A2	ALTERNATE No. 3 - BRICK 'C' BELDEN BRICK	MODULAR EBONY BLACK BLEND w/ HOLCIM 'SMITH GRAY' MORTAR MORTAR ALT: SOLOMON '85X DARK CHOCOLATE'	CONTACT THE BELDEN BRICK COMPANY AT 330-451-2031 FOR ORDERING SEE SPEC FOR ADDITIONAL INFO
A3	PREFINISHED ALUM. SILL FLASHING	A3 - BRIGHT SILVER A3a - PETERSEN ALUM # CEDAR 397C0290 SPRAY CODE'	SEE SPEC FOR ADDITIONAL INFO
A4	ALUMINUM STOREFRONT SYSTEM	ANODIZED ALUM.	RE: DWG. A602
A5	MEMBRANE ROOFING	GRAY	TOP OF SLOPED ROOF, CANOPY ROOF, AND BACK OF RAISED ROOF PROJECTIONS - SEE SPECIFICATIONS APPENDIX 'B'
A6	METAL SOFFIT PANELS	A6 - SOLID PANELS - BRIGHT SILVER A6a - 1/2 VENTED PANELS - BRIGHT SILVER	RE: DWG. A301-A304
A7	EXTERIOR PAINT	PT-19 / CL-9	RE: DWG. A603
A8	ALUMINUM CURTAIN WALL SYSTEM	ANODIZED ALUMINUM	RE: DWG. A602
A9	ALUMINUM COMPOSITE PANEL	BRIGHT SILVER	PROVIDE PANEL JOINTS AS SHOWN - PROVIDE ONE PIECE TIGHT FIT EXTRUDED MOLDING INSTALLATION SYSTEM WITH CENTER REVEAL TRIM BETWEEN PANELS AND J TRIM AT PANEL EDGES.
A10	NICHIIHA FIBER CEMENT EXTERIOR CLADDING	VINTAGEWOOD 'CEDAR'	PANELS SHALL EXTEND ONTO THE ROOF FOR THE FULL DEPTH OF THE BUMPOUT. CONTACT NICHIIHA AT 770-805-9466 FOR ORDERING. SEE SPEC FOR TRIM REQUIREMENTS AND ADDITIONAL INFO. ALL INCLUDED TRIM ('H', 'J', 'L', CORNER, ETC) TO MATCH FCP
A11	BLRD-2	PT-19 / CL-4	RE: DWG A603
A12	BLRD-4		RE: DWG A603
A13	GUARD RAIL TYPE "A"	GALVANIZED STEEL	RE: DWG B2/A507
A14	GUARD RAIL TYPE "B"	GALVANIZED STEEL	RE: DWG B2/A507
A15	BLRD-3	GALVANIZED	RE: DWG A603
A16	DOCK LEVELER / SEAL AND BUMPERS	LEVELER - FACTORY FINISH / SEAL AND BUMPERS - FACTORY FINISH - BLACK	PROVIDE BRICK BEHIND DOCK SEAL
A17	MASONRY CONTROL JOINT		MAX 20' OC
A18	OVERFLOW SCUPPER	MATCH COPING ABOVE	RE: DWG A2/A507
A19	ARCHITECTURAL CAST STONE	TANNERSTONE: AG-1	SEE SPEC FOR ADDITIONAL INFORMATION - MORTAR COLOR TO MATCH CAST STONE
A20	ALDI TOWER SIGN	BY SIGN VENDOR	7'-11 1/8" w. x 9'-5 1/2" h.; VERIFY SIGN SIZE PRIOR TO FRAMING OPENING SEE DETAIL C1/A504
A21	CRTB	NATURAL	RE: DWG A603 - SEE STRUCTURAL DWGS

EXTERIOR FINISH SCHEDULE			
KEY	MATERIAL / MFG.	COLOR / NO.	NOTES
A22	KNOX BOX	FACTORY FINISH	CONFIRM TYPE AND LOCATION WITH LOCAL FIRE MARSHAL
A23	AUTO DOOR SYSTEM & TRANSOM	ANODIZED ALUMINUM	RE: DWG A601 & A602
A24	ALDI LOGO SIGN	BY SIGN VENDOR	SURFACE MOUNTED SIGN: 15'-2 1/2" W. X 5'-1" H.
A25	8" X 8" PRE-FINISHED ALUM GUTTER	MATCH PREFINISHED METAL COPING	
A26	8" X 8" PRE-FINISHED ALUM DOWNSPOUT	MATCH PREFINISHED METAL COPING	TERMINATE AT CONC. SPLASH BLOCK
A27	ACP H/J TRIM / JOINT COVER		TYPICAL AT EDGES AND BUTT JOINTS OF ACP
A28	NICHIIHA FIBER CEMENT PANEL BASE FLASHING	PETERSEN ALUMINUM - #CEDAR 397C0290 SPRAY CODE'	SEE SPEC FOR ADDITIONAL INFO
A29	NOT USED		
A30	NOT USED		
A31	NICHIIHA CONTROL JOINT WITH "H" CLIP		
A32	NOT USED		
A33	NOT USED		
E1	EXIT DISCHARGE LIGHT	FACTORY FINISH	MOUNT @ 8'-0" A.F.F.
E2	WALL SCONCE	FACTORY FINISH	MOUNT @ 14'-8" A.F.F.; RE: DWG. A111 FOR DIMENSIONS
E3	JUNCTION BOX WITH COVER FOR FUTURE CARD READER		MOUNT CENTERED @ 46" A.F.F., SEE ELEC DWGS
E4	UTILITY METERING & C.T.	FACTORY FINISH	SEE ELECTRICAL DWGS
E5	EXTERIOR WALL PACK	FACTORY FINISH	MAN DOORS - MOUNT @ 9'-0" A.F.F., BREAK ROOM WINDOW @ 10'-0" A.F.F. ALL OTHER LOCATIONS - MOUNT @ 12'-0" A.F.F.
E6	EXTERIOR DUPLEX RECEPTACLE	FACTORY FINISH	MOUNT @ 1'-6" A.F.F. IN 4" SQUARE J-BOX
E7	NOT USED		
F1	FIRE DEPT. CONNECTION	FACTORY FINISH	SEE FIRE PROTECTION DWGS
F2	MOTOR GONG	FACTORY FINISH	SEE FIRE PROTECTION DWGS
P1	HOSE BIB	FACTORY FINISH	SEE PLUMBING DWGS
P2	RPZ DISCHARGE	FACTORY FINISH	SEE PLUMBING DWGS
P3	GAS METER	FACTORY FINISH	SEE PLUMBING DWGS
XX	GLAZING KEY		RE: DWG A602
XX	ALIGN KEY		A: ALIGN NICHIIHA PANEL JOINTS AND WINDOW MULLIONS B: ALIGN ALUMINUM COMPOSITE PANEL JOINTS AND WINDOW MULLIONS C: ALIGN NICHIIHA PANEL JOINTS, ALUMINUM COMPOSITE PANEL JOINTS, AND WINDOW MULLIONS

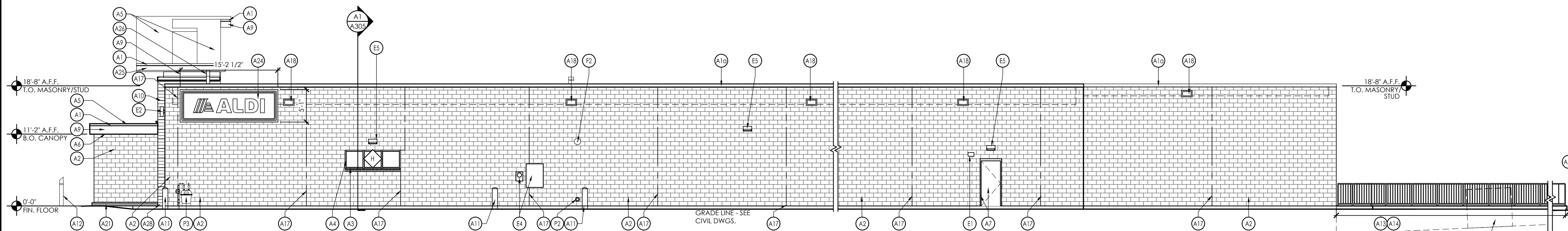

2 East Elevation
SCALE: 1/8" = 1'-0"

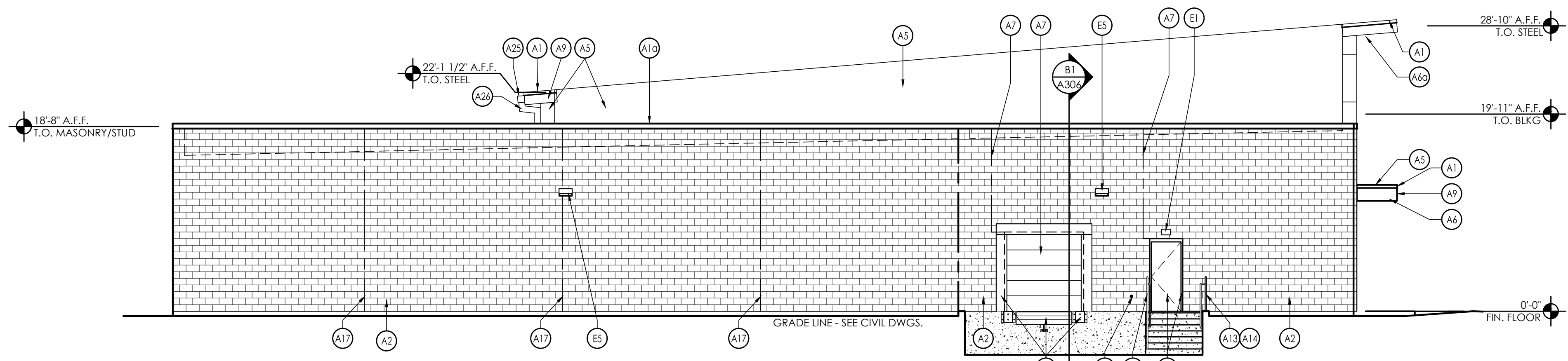

1 North Elevation
SCALE: 1/8" = 1'-0"

SIGNAGE			
DESCRIPTION	QUANTITY	SQ. FT. PER SIGN	TOTALS
TOWER SIGN	2	74.9	149.8
TOTAL SIGNAGE			149.8

SIGNAGE IS SHOWN FOR REFERENCE ONLY AND SHALL BE UNDER SEPARATE PERMIT SUBMITTAL

Issued: Doc. No. 4

A	Issued for Permit	03/19/21
B	Issued for Bid	04/05/21
C		
D		
E		

Revisions: Date:

1		
2		
3		
4		
5		
6		
7		
8		
9		

Seal Seal

PROJECT ARCHITECT/ENGINEER DATE

PROJECT LEAD DATE

PROJECT DESIGNER DATE

Copyright © 2021
APD Engineering & Architecture, P.L.L.C.
Drawing Alteration
It is a violation of law for any person, unless acting under the direction of licensed Architect, Professional Engineer, Landscape Architect, or Land Surveyor to alter any item on this document in any way. Any licensee who alters this document is required by law to affix his or her seal and to add the notation "Altered By:" followed by his or her signature and the specific description of the alteration or revision.

DO NOT SCALE PLANS
Copying, Printing, Software and other processes required to produce these prints can stretch or shrink the actual paper or layout. Therefore, scaling of this drawing may be inaccurate. Contact APD E&A with any need for additional dimensions or clarifications.

APD
ENGINEERING
ARCHITECTURE
615 Fishers Run Victor, NY 14564
585.742.2222 - www.apd.com

ALDI Inc.
4201 Bagley Avenue North
Faribault, MN 55021
(507) 333-9460
(507) 333-9475 Fax

ALDI Inc. Store #: 64
Cedar Falls, IA
219 Brandilynn Boulevard
Cedar Falls, IA
Black Hawk County
Project Name & Location:

Exterior Elevations
Drawing Name:

Date: 02/25/21 Project No. 20-0647B

Type: RHSDV7ER A-202

Drawn By: CB Scale: As Noted

Scale: As Noted Drawing No. 74

DESCRIPTION	QUANTITY	SQ. FT. PER SIGN	TOTALS
TOWER SIGN	2	74.9	149.8
TOTAL SIGNAGE			149.8
SIGNAGE IS SHOWN FOR REFERENCE ONLY AND SHALL BE UNDER SEPARATE PERMIT SUBMITTAL			



4 South Elevation
SCALE: 1/8" = 1'-0"

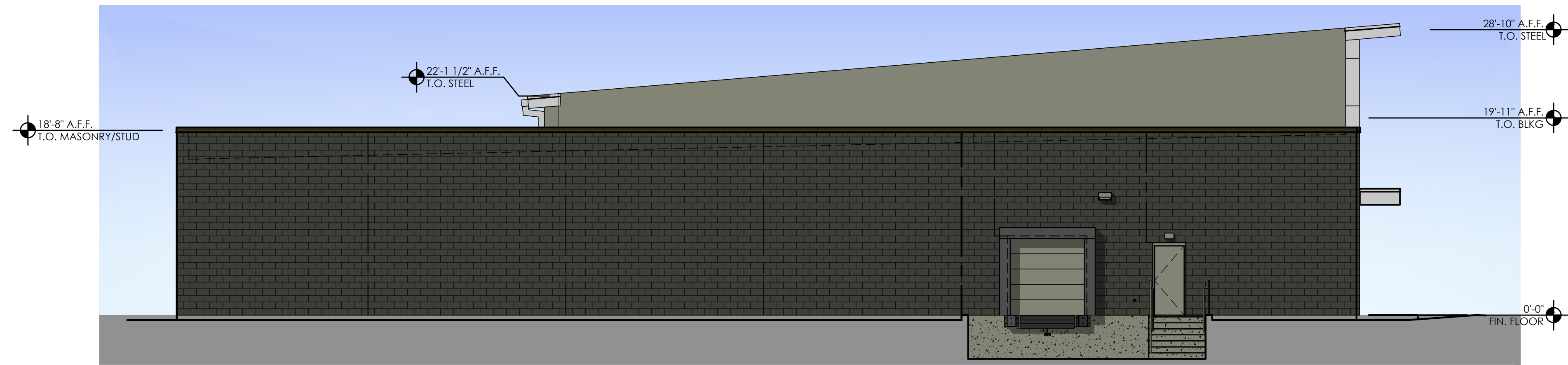

3 North Elevation
SCALE: 1/8" = 1'-0"

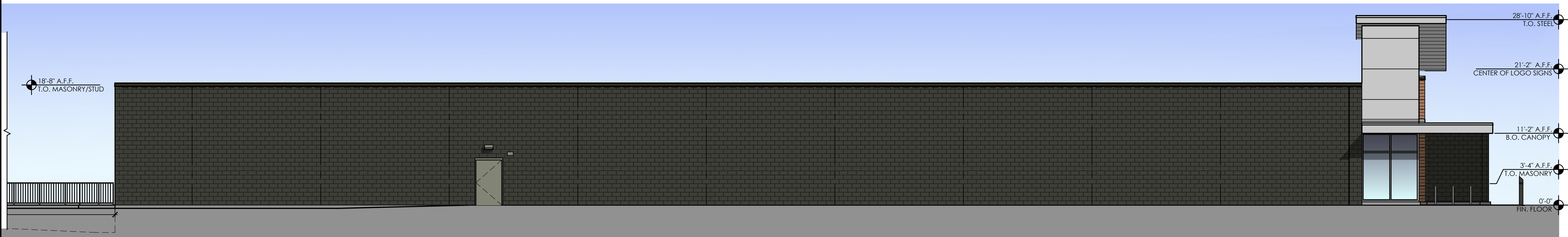

2 West Elevation
SCALE: 1/8" = 1'-0"

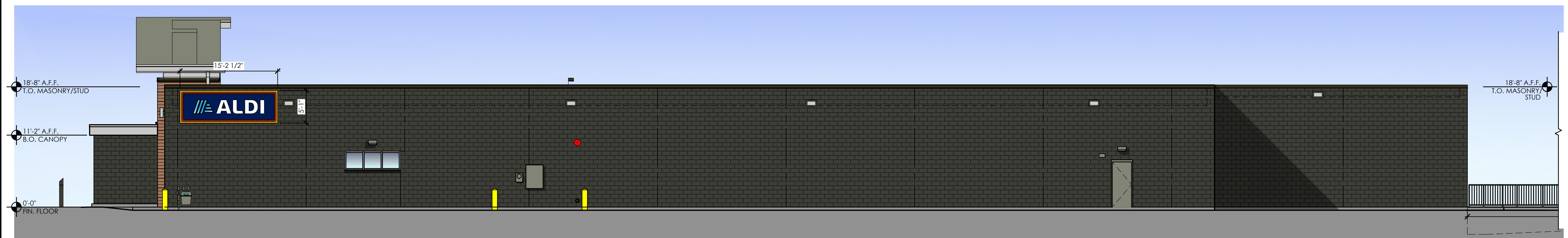

1 East Elevation
SCALE: 1/8" = 1'-0"

Issued: Item 4

Revisions:	Date:
A	Issued for Client Review 09/29/20
B	Issued for Client Review 11/11/20
C	Issued for Client Review 11/24/20
D	Issued for Client Review 12/03/20
E	Issued for Client Review 02/18/21
1	
2	
3	
4	
5	
6	
7	
8	
9	

Seal	Seal
PROJECT ARCHITECT/ENGINEER	DATE
PROJECT LEAD	DATE
PROJECT DESIGNER	DATE

Copyright © 2021
APD Engineering & Architecture, P.C.
Drawing Alteration
It is a violation of law for any person, unless acting under the direction of licensed Architect, Professional Engineer, Landscape Architect, or Land Surveyor to alter any item on this document in any way. Any licensee who offers this document is required by law to affix his or her seal and to add the notation "Altered By:" followed by his or her signature and the specific description of the alteration or revision.
DO NOT SCALE PLANS
Copying, Printing, Software and other processes required to produce these prints can stretch or shrink the actual paper or layout. Therefore, scaling of this drawing may be inaccurate. Contact APD E&A with any need for additional dimensions or clarifications.

APD
ENGINEERING
ARCHITECTURE
615 Fishers Run Victor, NY 14564
585.742.2222 - www.apd.com

ALDI Inc.
4201 Bagley Avenue North
Faribault, MN 55021
(507) 333-9469
(507) 333-9475 fax

ALDI Inc. Store #: XX
Cedar Falls, IA
Project Address
Cedar Falls, IA
Black Hawk County
Project Name & Location:

Exterior Elevations Drawing Name:	Project No. 20-0647A
Date: 09/28/20	
Type: RHSD-V7	
Drawn By: CB	CEE-5
Scale: As Noted	Drawing No.

PLOTTED: 2/18/2021 5:08 PM

EXTERIOR FINISH SCHEDULE			
KEY	MATERIAL / MFG.	COLOR / NO.	NOTES
A1	PREFINISHED METAL COPING	A1 - SILVER - AT HIGH ROOF & CANOPY A1a - PETERSEN ALUM - MUSKET GREY-AT BRICK A1b - PETERSEN ALUM - #CEDAR 397C0290 SPRAY CODE - AT NICHIIHA TOWERS	SEE SPECIFICATIONS APPENDIX 'B'
A2	BASE BID - BRICK 'A' SPEC-BRICK CONCRETE MASONRY VENEER	4WX8HX16L (12W @ CART WALL ONLY) CHESAPEAKE BLEND w/ HOLCIM 'SMITH GRAY' MORTAR ALT: SOLOMON '85X DARK CHOCOLATE'	CONTACT THE CONCRETE PRODUCTS GROUP AT 800-789-0872 FOR ORDERING SEE SPEC FOR ADDITIONAL INFO
	ALTERNATE No. 2 - BRICK 'B' QUICK-BRICK CONCRETE MASONRY VENEER	4WX8HX16L (12W @ CART WALL ONLY) MAROUS BLEND w/ HOLCIM 'SMITH GRAY' MORTAR ALT: SOLOMON '85X DARK CHOCOLATE'	CONTACT ECHELON MASONRY AT 800-899-8455 FOR ORDERING SEE SPEC FOR ADDITIONAL INFO
	ALTERNATE No. 3 - BRICK 'C' BELDEN BRICK	MODULAR EBONY BLACK BLEND w/ HOLCIM 'SMITH GRAY' MORTAR MORTAR ALT: SOLOMON '85X DARK CHOCOLATE'	CONTACT THE BELDEN BRICK COMPANY AT 330-451-2031 FOR ORDERING SEE SPEC FOR ADDITIONAL INFO
A3	PREFINISHED ALUM. SILL FLASHING	A3a - BRIGHT SILVER A3b - PETERSEN ALUM # CEDAR 397C0290 SPRAY CODE'	SEE SPEC FOR ADDITIONAL INFO
A4	ALUMINUM STOREFRONT SYSTEM	ANODIZED ALUM.	RE: DWG. A602
A5	MEMBRANE ROOFING	GRAY	TOP OF SLOPED ROOF, CANOPY ROOF, AND BACK OF RAISED ROOF PROJECTIONS - SEE SPECIFICATIONS APPENDIX 'B'
A6	METAL SOFFIT PANELS	A6 - SOLID PANELS - BRIGHT SILVER A6a - 1/2 VENTED PANELS - BRIGHT SILVER	RE: DWG. A301-A304
A7	EXTERIOR PAINT	PT-19 / CL-9	RE: DWG. A603
A8	ALUMINUM CURTAIN WALL SYSTEM	ANODIZED ALUMINUM	RE: DWG. A602
A9	ALUMINUM COMPOSITE PANEL	BRIGHT SILVER	PROVIDE PANEL JOINTS AS SHOWN - PROVIDE ONE PIECE TIGHT FIT EXTRUDED MOLDING INSTALLATION SYSTEM WITH CENTER REVEAL TRIM BETWEEN PANELS AND J TRIM AT PANEL EDGES.
A10	NICHIIHA FIBER CEMENT EXTERIOR CLADDING	VINTAGEWOOD 'CEDAR'	PANELS SHALL EXTEND ONTO THE ROOF FOR THE FULL DEPTH OF THE BUMPOUT. CONTACT NICHIIHA AT 770-805-9466 FOR ORDERING. SEE SPEC FOR TRIM REQUIREMENTS AND ADDITIONAL INFO. ALL INCLUDED TRIM (H, J, L, CORNER, ETC) TO MATCH FCP
A11	BLRD-2	PT-19 / CL-4	RE: DWG A603
A12	BLRD-4		RE: DWG A603
A13	GUARD RAIL TYPE "A"	GALVANIZED STEEL	RE: DWG B2/A507
A14	GUARD RAIL TYPE "B"	GALVANIZED STEEL	RE: DWG B2/A507
A15	BLRD-3	GALVANIZED	RE: DWG A603
A16	DOCK LEVELER / SEAL AND BUMPERS	LEVELER - FACTORY FINISH / SEAL AND BUMPERS - FACTORY FINISH - BLACK	PROVIDE BRICK BEHIND DOCK SEAL
A17	MASONRY CONTROL JOINT		MAX 20' OC
A18	OVERFLOW SCUPPER	MATCH COPING ABOVE	RE: DWG A2/A507
A19	ARCHITECTURAL CAST STONE	TANNERSTONE: AG-1	SEE SPEC FOR ADDITIONAL INFORMATION - MORTAR COLOR TO MATCH CAST STONE
A20	ALDI TOWER SIGN	BY SIGN VENDOR	7'-11 1/8" w. x 9'-5 1/2" h.; VERIFY SIGN SIZE PRIOR TO FRAMING OPENING SEE DETAIL C1/A504
A21	CRTB	NATURAL	RE: DWG A603 - SEE STRUCTURAL DWGS

EXTERIOR FINISH SCHEDULE			
KEY	MATERIAL / MFG.	COLOR / NO.	NOTES
A22	KNOX BOX	FACTORY FINISH	CONFIRM TYPE AND LOCATION WITH LOCAL FIRE MARSHAL
A23	AUTO DOOR SYSTEM & TRANSOM	ANODIZED ALUMINUM	RE: DWG A601 & A602
A24	ALDI LOGO SIGN	BY SIGN VENDOR	SURFACE MOUNTED SIGN: 15'-2 1/2" W. X 5'-1" H.
A25	8" X 8" PRE-FINISHED ALUM GUTTER	MATCH PREFINISHED METAL COPING	
A26	8" X 8" PRE-FINISHED ALUM DOWNSPOUT	MATCH PREFINISHED METAL COPING	TERMINATE AT CONC. SPLASH BLOCK
A27	ACP H/J TRIM / JOINT COVER		TYPICAL AT EDGES AND BUTT JOINTS OF ACP
A28	NICHIIHA FIBER CEMENT PANEL BASE FLASHING	PETERSEN ALUMINUM - #CEDAR 397C0290 SPRAY CODE'	SEE SPEC FOR ADDITIONAL INFO
A29	NOT USED		
A30	NOT USED		
A31	NICHIIHA CONTROL JOINT WITH "H" CLIP		
A32	NOT USED		
A33	NOT USED		
E1	EXIT DISCHARGE LIGHT	FACTORY FINISH	MOUNT @ 8'-0" A.F.F.
E2	WALL SCONCE	FACTORY FINISH	MOUNT @ 14'-8" A.F.F.; RE: DWG. A111 FOR DIMENSIONS
E3	JUNCTION BOX WITH COVER FOR FUTURE CARD READER		MOUNT CENTERED @ 46" A.F.F., SEE ELEC DWGS
E4	UTILITY METERING & C.T.	FACTORY FINISH	SEE ELECTRICAL DWGS
E5	EXTERIOR WALL PACK	FACTORY FINISH	MAN DOORS - MOUNT @ 9'-0" A.F.F., BREAK ROOM WINDOW @ 10'-0" A.F.F. LOADING DOCK - MOUNT @ 12'-0" A.F.F.
E6	EXTERIOR DUPLEX RECEPTACLE	FACTORY FINISH	MOUNT @ 1'-6" A.F.F. IN 4" SQUARE J-BOX
E7	NOT USED		
F1	FIRE DEPT. CONNECTION	FACTORY FINISH	SEE FIRE PROTECTION DWGS
F2	MOTOR GONG	FACTORY FINISH	SEE FIRE PROTECTION DWGS
P1	HOSE BIB	FACTORY FINISH	SEE PLUMBING DWGS
P2	RPZ DISCHARGE	FACTORY FINISH	SEE PLUMBING DWGS
P3	GAS METER	FACTORY FINISH	SEE PLUMBING DWGS
XX	GLAZING KEY		RE: DWG A602
VV	ALIGN KEY		A: ALIGN NICHIIHA PANEL JOINTS AND WINDOW MULLIONS B: ALIGN ALUMINUM COMPOSITE PANEL JOINTS AND WINDOW MULLIONS C: ALIGN NICHIIHA PANEL JOINTS, ALUMINUM COMPOSITE PANEL JOINTS, AND WINDOW MULLIONS

Issued:	03/19/21
A Issued for Permit	03/19/21
B	
C	
D	
E	
Revisions:	Date:
1	
2	
3	
4	
5	
6	
7	
8	
9	

Seal	Seal
PROJECT ARCHITECT/ENGINEER	DATE
PROJECT LEAD	DATE
PROJECT DESIGNER	DATE

Copyright © 2020
APD Engineering & Architecture, P.L.L.C.
Drawing Alteration
It is a violation of law for any person, unless acting under the
direction of Licensed Architect, Professional Engineer, Landscape
Architect, or Land Surveyor to alter any item on this document in any
way. Any licensee who alters this document is required by law to affix
his or her seal and to add the notation "Altered By:" followed by his or
her signature and the specific description of the alteration or revision.

DO NOT SCALE PLANS
Copying, Printing, Software and other processes required to produce
these prints can stretch or shrink the actual paper or layout.
Therefore, scaling of this drawing may be inaccurate. Contact APD
& A with any need for additional dimensions or clarifications.

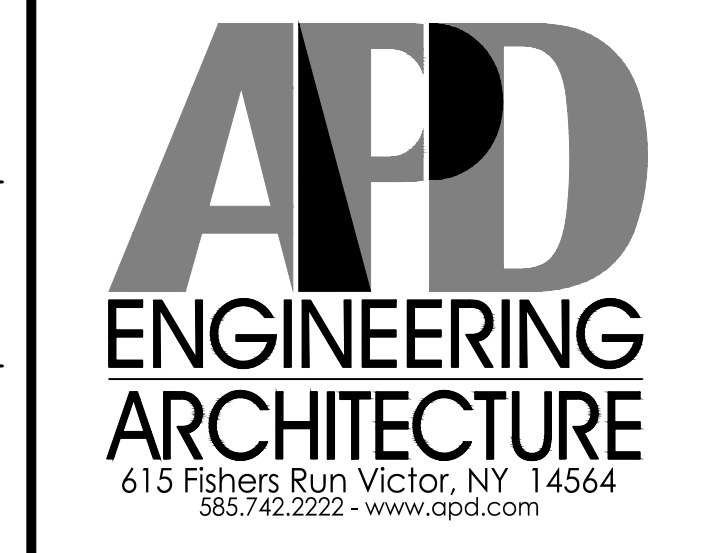

ALDI Inc. Store #: 64
Cedar Falls, IA
219 Brandilynn Boulevard
Cedar Falls, IA
Black Hawk County
Project Name & Location:

Exterior Elevations Drawing Name:	Project No. 20-0647B
Date: 02/25/21	
Type: RHSDV7ER	
Drawn By: CB	A-201
Scale: As Noted	Drawing No.

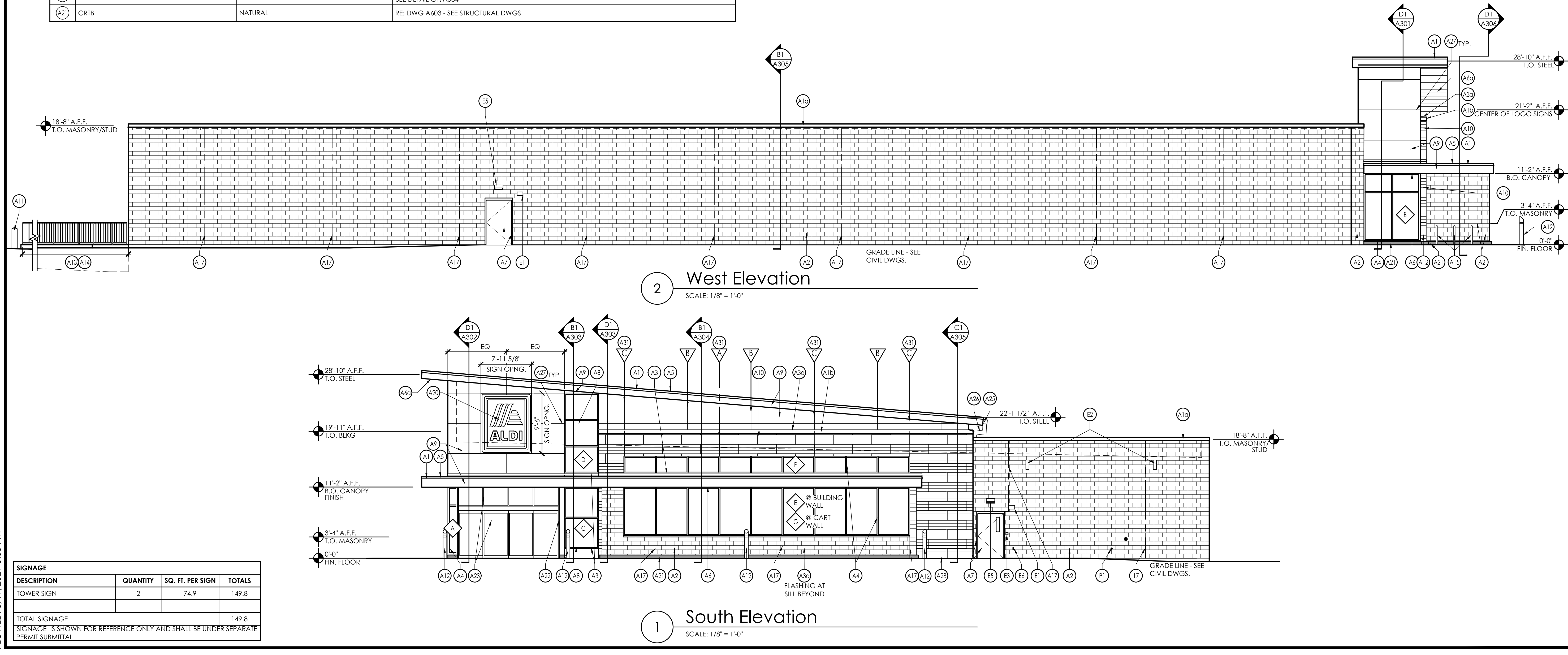

SIGNAGE			
DESCRIPTION	QUANTITY	SQ. FT. PER SIGN	TOTALS
TOWER SIGN	2	74.9	149.8
TOTAL SIGNAGE			149.8

SIGNAGE IS SHOWN FOR REFERENCE ONLY AND SHALL BE UNDER SEPARATE PERMIT SUBMITTAL

PLOTTED: 3/17/2021 5:03 PM

EXTERIOR FINISH SCHEDULE			
KEY	MATERIAL / MFG.	COLOR / NO.	NOTES
A1	PREFINISHED METAL COPING	A1 - SILVER - AT HIGH ROOF & CANOPY A1a - PETERSEN ALUM - MUSKET GREY-AT BRICK A1b - PETERSEN ALUM - #CEDAR 397C0290 SPRAY CODE - AT NICHIIA TOWERS	SEE SPECIFICATIONS APPENDIX 'B'
A2	BASE BID - BRICK 'A' SPEC-BRICK CONCRETE MASONRY VENEER	4WXBH16L (12W @ CART WALL ONLY) CHESAPEAKE BLEND w/ HOLCIM 'SMITH GRAY' MORTAR MORTAR ALT: SOLOMON '85X DARK CHOCOLATE'	CONTACT THE CONCRETE PRODUCTS GROUP AT 800-789-0872 FOR ORDERING SEE SPEC FOR ADDITIONAL INFO
A2	ALTERNATE No. 2 - BRICK 'B' QUICK-BRICK CONCRETE MASONRY VENEER	4WXBH16L (12W @ CART WALL ONLY) MAROUS BLEND w/ HOLCIM 'SMITH GRAY' MORTAR MORTAR ALT: SOLOMON '85X DARK CHOCOLATE'	CONTACT ECHELON MASONRY AT 800-899-8455 FOR ORDERING SEE SPEC FOR ADDITIONAL INFO
A2	ALTERNATE No. 3 - BRICK 'C' BELDEN BRICK	MODULAR EBONY BLACK BLEND w/ HOLCIM 'SMITH GRAY' MORTAR MORTAR ALT: SOLOMON '85X DARK CHOCOLATE'	CONTACT THE BELDEN BRICK COMPANY AT 330-451-2031 FOR ORDERING SEE SPEC FOR ADDITIONAL INFO
A3	PREFINISHED ALUM. SILL FLASHING	A3 - BRIGHT SILVER A3a - PETERSEN ALUM # CEDAR 397C0290 SPRAY CODE'	SEE SPEC FOR ADDITIONAL INFO
A4	ALUMINUM STOREFRONT SYSTEM	ANODIZED ALUM.	RE: DWG. A602
A5	MEMBRANE ROOFING	GRAY	TOP OF SLOPED ROOF, CANOPY ROOF, AND BACK OF RAISED ROOF PROJECTIONS - SEE SPECIFICATIONS APPENDIX 'B'
A6	METAL SOFFIT PANELS	A6 - SOLID PANELS - BRIGHT SILVER A6a - 1/2 VENTED PANELS - BRIGHT SILVER	RE: DWG. A301-A304
A7	EXTERIOR PAINT	PT-19 / CL-9	RE: DWG. A603
A8	ALUMINUM CURTAIN WALL SYSTEM	ANODIZED ALUMINUM	RE: DWG. A602
A9	ALUMINUM COMPOSITE PANEL	BRIGHT SILVER	PROVIDE PANEL JOINTS AS SHOWN - PROVIDE ONE PIECE TIGHT FIT EXTRUDED MOLDING INSTALLATION SYSTEM WITH CENTER REVEAL TRIM BETWEEN PANELS AND J TRIM AT PANEL EDGES.
A10	NICHIIHA FIBER CEMENT EXTERIOR CLADDING	VINTAGEWOOD 'CEDAR'	PANELS SHALL EXTEND ONTO THE ROOF FOR THE FULL DEPTH OF THE BUMPOUT. CONTACT NICHIIHA AT 770-805-9466 FOR ORDERING. SEE SPEC FOR TRIM REQUIREMENTS AND ADDITIONAL INFO. ALL INCLUDED TRIM (H, J, L, CORNER, ETC) TO MATCH FCP
A11	BLRD-2	PT-19 / CL-4	RE: DWG A603
A12	BLRD-4		RE: DWG A603
A13	GUARD RAIL TYPE "A"	GALVANIZED STEEL	RE: DWG B2/A507
A14	GUARD RAIL TYPE "B"	GALVANIZED STEEL	RE: DWG B2/A507
A15	BLRD-3	GALVANIZED	RE: DWG A603
A16	DOCK LEVELER / SEAL AND BUMPERS	LEVELER - FACTORY FINISH / SEAL AND BUMPERS - FACTORY FINISH - BLACK	PROVIDE BRICK BEHIND DOCK SEAL
A17	MASONRY CONTROL JOINT		MAX 20' OC
A18	OVERFLOW SCUPPER	MATCH COPING ABOVE	RE: DWG A2/A507
A19	ARCHITECTURAL CAST STONE	TANNERSTONE: AG-1	SEE SPEC FOR ADDITIONAL INFORMATION - MORTAR COLOR TO MATCH CAST STONE
A20	ALDI TOWER SIGN	BY SIGN VENDOR	7'-11 1/8" w. x 9'-5 1/2" h.; VERIFY SIGN SIZE PRIOR TO FRAMING OPENING SEE DETAIL C1/A504
A21	CRTB	NATURAL	RE: DWG A603 - SEE STRUCTURAL DWGS

EXTERIOR FINISH SCHEDULE			
KEY	MATERIAL / MFG.	COLOR / NO.	NOTES
A22	KNOX BOX	FACTORY FINISH	CONFIRM TYPE AND LOCATION WITH LOCAL FIRE MARSHAL
A23	AUTO DOOR SYSTEM & TRANSOM	ANODIZED ALUMINUM	RE: DWG A601 & A602
A24	ALDI LOGO SIGN	BY SIGN VENDOR	SURFACE MOUNTED SIGN: 15'-2 1/2" W. X 5'-1" H.
A25	8" X 8" PRE-FINISHED ALUM GUTTER	MATCH PREFINISHED METAL COPING	
A26	8" X 8" PRE-FINISHED ALUM DOWNSPOUT	MATCH PREFINISHED METAL COPING	TERMINATE AT CONC. SPLASH BLOCK
A27	ACP H/J TRIM / JOINT COVER		TYPICAL AT EDGES AND BUTT JOINTS OF ACP
A28	NICHIIHA FIBER CEMENT PANEL BASE FLASHING	PETERSEN ALUMINUM - #CEDAR 397C0290 SPRAY CODE'	SEE SPEC FOR ADDITIONAL INFO
A29	NOT USED		
A30	NOT USED		
A31	NICHIIHA CONTROL JOINT WITH "H" CLIP		
A32	NOT USED		
A33	NOT USED		
E1	EXIT DISCHARGE LIGHT	FACTORY FINISH	MOUNT @ 8'-0" A.F.F.
E2	WALL SCONCE	FACTORY FINISH	MOUNT @ 14'-8" A.F.F.; RE: DWG. A111 FOR DIMENSIONS
E3	JUNCTION BOX WITH COVER FOR FUTURE CARD READER		MOUNT CENTERED @ 46" A.F.F., SEE ELEC DWGS
E4	UTILITY METERING & C.T.	FACTORY FINISH	SEE ELECTRICAL DWGS
E5	EXTERIOR WALL PACK	FACTORY FINISH	MAN DOORS - MOUNT @ 9'-0" A.F.F., BREAK ROOM WINDOW @ 10'-0" A.F.F. LOADING DOCK - MOUNT @ 12'-0" A.F.F.
E6	EXTERIOR DUPLEX RECEPTACLE	FACTORY FINISH	MOUNT @ 1'-6" A.F.F. IN 4" SQUARE J-BOX
E7	NOT USED		
F1	FIRE DEPT. CONNECTION	FACTORY FINISH	SEE FIRE PROTECTION DWGS
F2	MOTOR GONG	FACTORY FINISH	SEE FIRE PROTECTION DWGS
P1	HOSE BIB	FACTORY FINISH	SEE PLUMBING DWGS
P2	RPZ DISCHARGE	FACTORY FINISH	SEE PLUMBING DWGS
P3	GAS METER	FACTORY FINISH	SEE PLUMBING DWGS
XX	GLAZING KEY		RE: DWG A602
VV	ALIGN KEY		A: ALIGN NICHIIHA PANEL JOINTS AND WINDOW MULLIONS B: ALIGN ALUMINUM COMPOSITE PANEL JOINTS AND WINDOW MULLIONS C: ALIGN NICHIIHA PANEL JOINTS, ALUMINUM COMPOSITE PANEL JOINTS, AND WINDOW MULLIONS

Issued:	Doc. No.
A Issued for Permit	03/19/21
B	
C	
D	
E	
Revisions:	Date:
1	
2	
3	
4	
5	
6	
7	
8	
9	

Seal	Seal
PROJECT ARCHITECT/ENGINEER	DATE
PROJECT LEAD	DATE
PROJECT DESIGNER	DATE

Copyright © 2020
APD Engineering & Architecture, P.L.L.C.
Drawing Alteration
It is a violation of law for any person, unless acting under the
direction of a Licensed Architect, Professional Engineer, Landscape
Architect, or Land Surveyor to alter any item on this document in any
way. Any licensee who alters this document is required by law to affix
his or her seal and to add the notation "Altered By:" followed by his or
her signature and the specific description of the alteration or revision.

DO NOT SCALE PLANS
Copying, Printing, Software and other processes required to produce
these prints can stretch or shrink the actual paper or layout.
Therefore, scaling of this drawing may be inaccurate. Contact APD
E&A with any need for additional dimensions or clarifications.

615 Fishers Run Victor, NY 14564
585.742.2222 - www.apd.com

4201 Bagley Avenue North
Faribault, MN 55021
(507) 333-9460
(507) 333-9475 Fax

ALDI Inc. Store #: 64
Cedar Falls, IA
219 Brandilynn Boulevard
Cedar Falls, IA
Black Hawk County
Project Name & Location:

Exterior Elevations Drawing Name:	Project No.
Date: 02/25/21	20-0647B
Type: RHSDV7ER	
Drawn By: CB	A-202
Scale: As Noted	Drawing No.

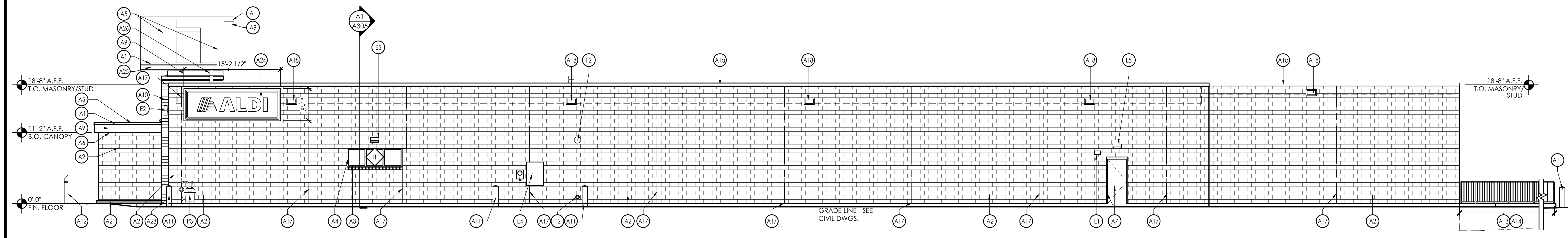

2 East Elevation
SCALE: 1/8" = 1'-0"

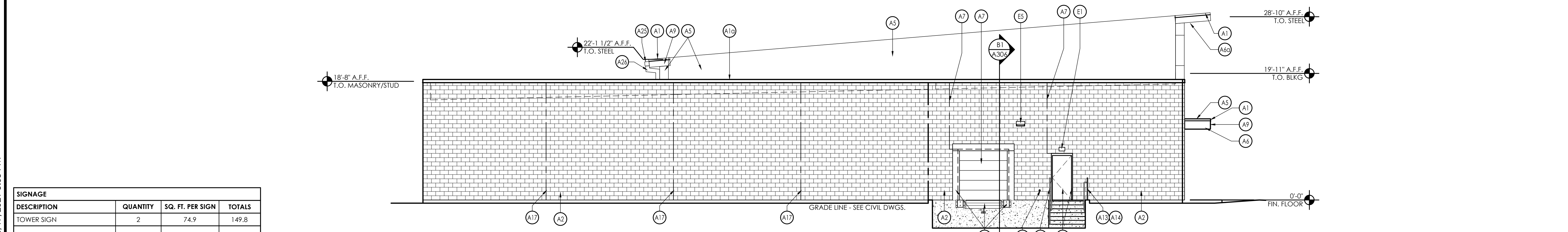

1 North Elevation
SCALE: 1/8" = 1'-0"

SIGNAGE			
DESCRIPTION	QUANTITY	SQ. FT. PER SIGN	TOTALS
TOWER SIGN	2	74.9	149.8
TOTAL SIGNAGE			149.8

SIGNAGE IS SHOWN FOR REFERENCE ONLY AND SHALL BE UNDER SEPARATE PERMIT SUBMITTAL

CEDAR FALLS, IA - AREA SUMMARY		
OCCUPANCY USE	ROOM NAME	SQUARE FOOTAGE
MERCANTILE (M)	SALES / VESTIBULE	12,541
	UNISEX 2	84
	UNISEX 1	76
	HALL	137
	SUBTOTAL (MERCANTILE)	12,838
BUSINESS (B)	OFFICE	190
	BREAK ROOM	305
	ECOMMERCE	175
	SUBTOTAL (BUSINESS)	670
STORAGE / STOCK (S-2)	BACKROOM	4,571
	COOLER	1,313
	FREEZER	648
SUBTOTAL (STORAGE / STOCK)	6,532	
SUBTOTAL (OCCUPANCIES)		20,040
EXTERIOR / INTERIOR WALLS / UNOCCUPIED SPACE		1,103
BUILDING SQUARE FOOTAGE		21,143
EXTERIOR CANOPY		890
TOTAL SQUARE FOOTAGE (INCLUDING CANOPY)		22,033

CEDAR FALLS, IA - OPERATIONS DATA	
ITEM	QUANTITY
LINEAR FOOTAGE OF BASE (PRODUCE INCLUDED)	828'-7"
ASSUMED PALLET STORAGE	73
BUILDING DIMENSIONS	119'-4" x 153'-4"
SALES FLOOR DIMENSIONS	74'-6" x 151'-1"
LENGTH OF MULTIDECK	120'
COOLER MILK DOORS	4
COOLER GENERAL DOORS	12
FREEZER GENERAL DOORS	16
SPOT MERCHANDISERS	10
CART STORAGE	120

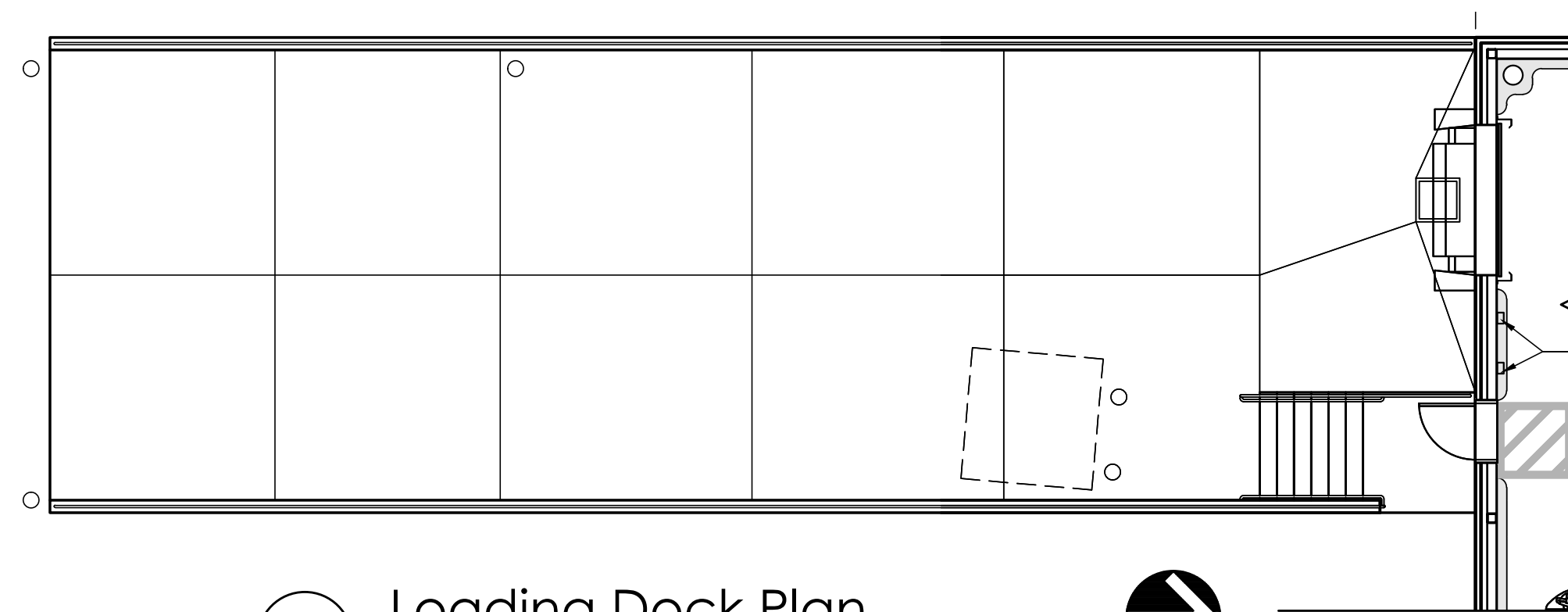

- NOTES:
- THIS DRAWING IS FOR GENERAL FIXTURING LAYOUT AND REFERENCE TO EQUIPMENT ONLY. ALL INFORMATION IS FOR ALDI OPERATIONAL USE ONLY AND SHALL NOT BE USED FOR CONSTRUCTION OR BIDDING PURPOSES.
 - ALL DIMENSIONS TO WALLS ARE TO FACE OF STUD UNLESS NOTED OTHERWISE.
 - THIS FACILITY DOES NOT CONTAIN A BAKERY, A BUTCHER, A DELI OR FISH COUNTER.
 - ALL FOOD IS PREPACKAGED. THERE IS NO ON SITE FOOD PREPARATION.
 - GONDOLA LOCATIONS ARE MEASURED FROM THE FACE OF THE STAINLESS STEEL PRICE TAG MOLDING (SSPFM).

2 Loading Dock Plan
SCALE: 1/8" = 1'-0"

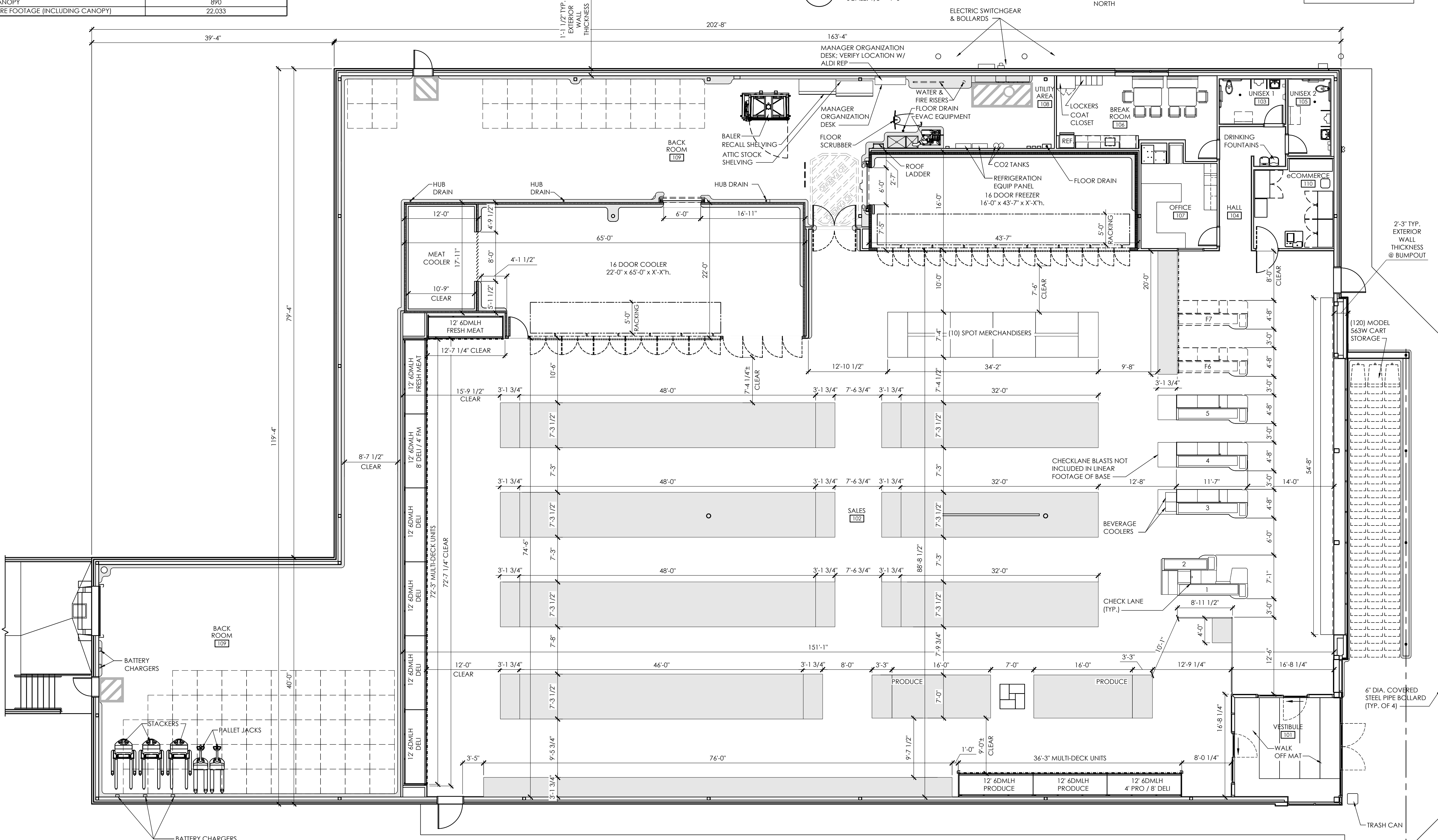

1 Operations Plan
SCALE: 1/8" = 1'-0"



Issued:		Doc. No.
A	Issued for Client Review	09/29/20
B	Issued for Client Review	11/11/20
C	Issued for Client Review	11/24/20
D	Issued for Client Review	12/03/20
E	Issued for Client Review	02/18/21

Revisions:		Date:
1		
2		
3		
4		
5		
6		
7		
8		
9		

Seal PROJECT ARCHITECT/ENGINEER DATE

PROJECT LEAD DATE

PROJECT DESIGNER DATE

Copyright © 2021 APD Engineering & Architecture, P.L.L.C.
Drawing Alteration
It is a violation of law for any person, unless acting under the direction of a Licensed Architect, Professional Engineer, Landscape Architect, or Land Surveyor to alter any item on this document in any way. Any licensee who alters this document is required by law to affix his or her seal and to add the notation "Altered By:" followed by his or her signature and the specific description of the alteration or revision.
DO NOT SCALE PLANS
Copying, Printing, Software and other processes required to produce these prints can stretch or shrink the actual paper or layout. Therefore, scaling of this drawing may be inaccurate. Contact APD E&A with any need for additional dimensions or clarifications.



ALDI Inc. Store #: XX
Cedar Falls, IA
Project Address
Cedar Falls, IA
Black Hawk County
Project Name & Location:

Operations Plan	
Drawing Name:	Project No.
Date: 09/28/20	20-0647A
Type: RHSD-V7	CFP-3
Drawn By: CB	Scale: As Noted
Drawn By: CB	Project No. 20-0647A
Drawn By: CB	CFP-3
Scale: As Noted	Project No. 20-0647A
Scale: As Noted	CFP-3
Scale: As Noted	Project No. 20-0647A
Scale: As Noted	CFP-3

PLOTTED: 2/18/2021 4:04 PM



DEPARTMENT OF COMMUNITY DEVELOPMENT

City of Cedar Falls
 220 Clay Street
 Cedar Falls, Iowa 50613
 Phone: 319-273-8606
 Fax: 319-273-8610
www.cedarfalls.com

MEMORANDUM

Planning & Community Services Division

TO: Planning & Zoning Commission

FROM: Karen Howard, AICP, Planning & Community Services Manager

DATE: April 22, 2021

SUBJECT: Zoning Map and Text Amendments - Downtown Character District Code and Regulating Plan

A public review draft of a new zoning code and zoning map for the Downtown Character District were presented during a special virtual Cedar Falls Planning and Zoning Commission meeting on February 17, 2021. Since that time, the proposed code and regulating plan map have been available for public review and comment on the project webpage: www.ourcedarfalls.com. Over the last two months, consultants and staff have met virtually with the Planning and Zoning Commission at four special work sessions to discuss the various elements of the proposed code and regulating plan and answer questions from the Commission. Staff also provided opportunities for work session discussions with development professionals and with Community Main Street, and encouraged the public to view and submit questions or comments to the Planning Division. All property owners in the area were notified by mail of the public hearing date and provided within instructions on how to participate in the hearing. Notice was also published in the Courier for both the proposed new zoning code for Downtown and for the rezoning of property to the new designation of Downtown Character District (CD-DT), noting that the Downtown Character District Regulating Plan (attached) will be the new zoning map for the area.

Public input is again invited at the public hearing on April 28, 2021. There have been no additional requests for amendments to the draft zoning code or regulating plan. The consultants and staff are working to revise to the draft as directed by the Commission at your last meeting. If there are no additional changes recommended, we will forward the revised draft of the code for final consideration and recommendation at your May 12th meeting. A recommendation on rezoning property to the new designation could also take place at your May 12th meeting following your vote on the draft code.

The updated zoning regulations are an important step in implementing the *Imagine Downtown! Vision Plan*, which was adopted by the Cedar Falls City Council in November 2019. The plan was the result of public workshops and other public outreach events that took place in 2019, where community members were invited to share their feedback and ideas for the future of Downtown and surrounding neighborhoods. The adoption of new zoning regulations will encourage development that is consistent with the community's vision.

RECOMMENDATION: Staff recommends that the Commission hear public testimony and provide any additional direction on amendments to the draft code and regulating plan and also consider rezoning property within the area covered by the regulating plan to the new designation of Downtown Character District (CD-DT). Following any public comment and discussion by the Commission, staff recommends closing the public hearing and directing staff to bring the revised draft to the May 12th meeting for final discussion and vote.

*3 Required street connection between Walnut Street and either College Street or Ica Street. The exact route is to be determined through platting. Consult the Zoning Administrator.

A Comfortable 5 Minute Walk

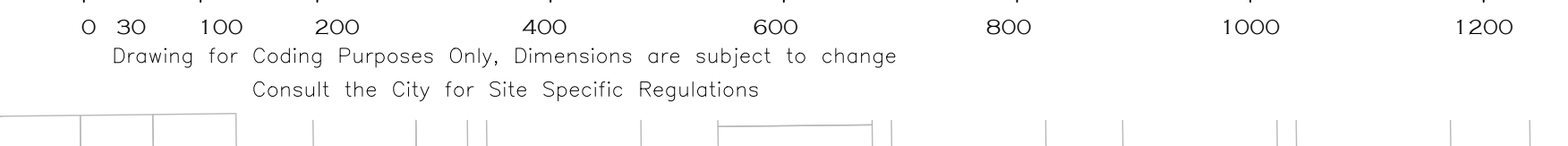

UNDERSTANDING THE REGULATING PLAN

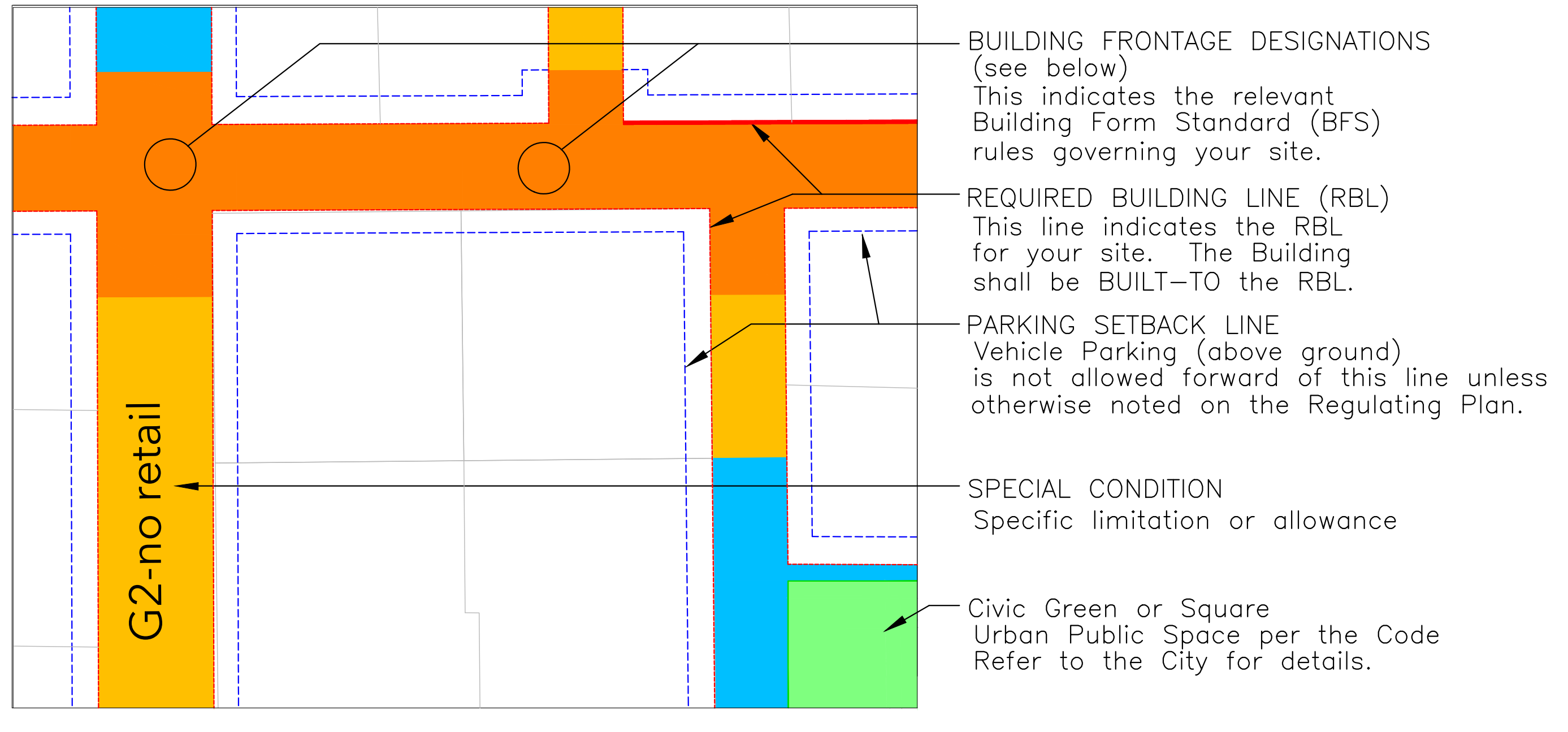

Color and Symbol Key

Urban General	Storefront	Public Open Space
Urban General 2	Req'd Building Line (RBL)	Civic Structure
Neighborhood Medium	Parking Setback	Downtown Character Study Area Bounds
Neighborhood Small	New Streets	Railway

SPECIAL CONDITIONS
 *1. see the Urban General BFS, 193.2.F.4.b, for more information.
 *2. see the Neighborhood Medium BFS, 193.4.F.3.b or the Neighborhood Small BFS, 193.4.E.3.b, for more information.
 *3. Consult with the Zoning Administrator for more information.

DEPARTMENT OF COMMUNITY DEVELOPMENT



City of Cedar Falls
 220 Clay Street
 Cedar Falls, Iowa 50613
 Phone: 319-273-8600
 Fax: 319-273-8610
 www.cedarfalls.com

MEMORANDUM Planning & Community Services Division

TO: Planning & Zoning Commission
FROM: Chris Sevy, Planner I
DATE: April 20, 2021
SUBJECT: Scooter's Coffee Site Plan: Case # SP21-001

REQUEST: Site plan approval for construction of a new drive-thru and sit-down coffee establishment.

PETITIONER: B3 Brew, LLC (developer); Robinson Engineering (engineer)

LOCATION: 315 Viking Plaza Drive

PROPOSAL

The applicant proposes to construct a one story, 1,927 square foot Scooter's Coffee, the second such establishment to be built in Cedar Falls, on 315 Viking Plaza Drive. The proposal includes indoor dining, a drive through, parking for patrons, and a dumpster enclosure. The proposed layout of the site sits on about 1 acre with the entrance coming off of Viking Plaza Drive.

BACKGROUND

The Target retail commercial area (East Viking Plaza Addition) was established in early 2008. The plat established the main development areas for the Target store, Scheels, and other strip mall stores along the east edge of the development. It also established several 1-acre lots that border Viking Road with primary access from inside the development. The development was rezoned from (A-1) Agricultural District to (HWY-1) Highway Commercial District in 2003. Immediate neighbors include other food establishments such as Culver's and Cane's.

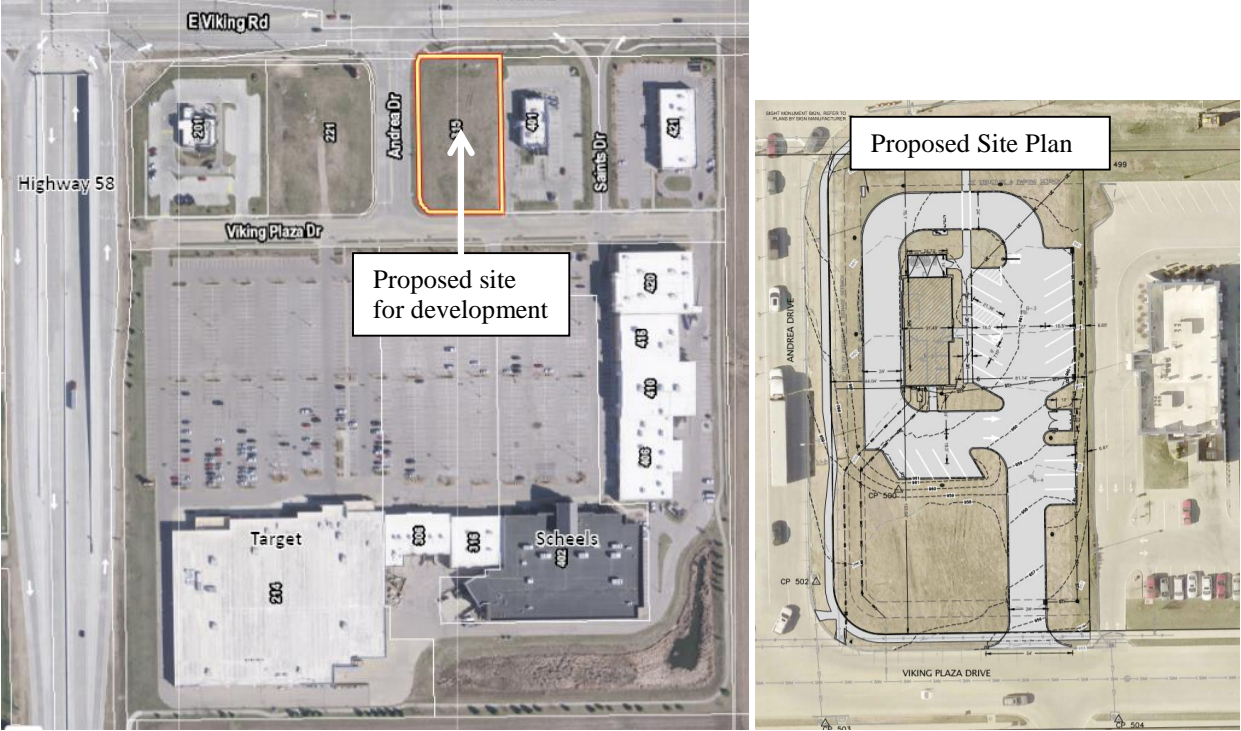

ANALYSIS

The HWY-1 District is intended to promote general service commercial uses that serve a broader market area (i.e. city-wide or regional customer base). The ordinance requires a detailed site plan review prior to approval in order to ensure that the development site satisfies a number of basic aesthetic standards. Attention to details such as parking, open green space, landscaping, signage, building design and other similar factors help to ensure orderly development in the entire area.

Following is a review of the zoning ordinance requirements for the proposed development:

- 1) **Use:** Restaurants are listed as a permitted use in the HWY-1 District and a coffee shop fits into that category. **Use is allowed.**

- 2) **Setbacks:** There is a platted building setback of 20 feet along all three frontages (Viking Plaza Drive, Andrea Drive, and Viking Road). The building is 76 feet from Viking Road, 44 feet from Andrea Drive, and 154 feet from Viking Plaza Drive. At these distances the building more than meets the setback requirement. The default side yard setback is 5 feet. The district also requires that a 20-foot landscaped setback be maintained along streets and accessways. Drives, aisles, and parking areas may not encroach into this landscaped setback. The applicant’s site plan conforms to these standards. **Building setbacks are satisfied. The parking lot setbacks are also satisfied.**

- 3) Parking: Restaurants require one parking space for every 100 square feet of gross floor area, plus one parking space for every two employees with a minimum of five parking spaces for employee parking. At a net floor area of 1735 square feet, the applicant is providing 23 parking spaces (18 customer spaces + 5 employee spaces). For a drive through fast food restaurant, five stacking spaces are required behind the window. There are at least six stacking spaces between the window and the entrance of the drive-thru. The parking meets the zoning standards with minimum stall dimensions of 9' x 19' and a 24-foot wide aisle (24 feet is the minimum requirement).

The amount and dimension of the parking stalls and drives are met.

- 4) Open Green Space: The HWY-1 District requires that open green space/landscape area be provided at the rate of 10% of the development site excluding the required 20-foot landscaped setback area. Below is a summary that details how this provision is met.

<u>New Development Site</u>	47,350 SF	
Required Open/Green Space	4,735 SF	10%
Provided Open/Green Space	10,600 SF	22.4%

Landscaping is shown throughout the site, both around the building as well as within the parking lot, along the streets and required setbacks. For clarity, the 10,600 is the provided green space in addition to the landscaped setback.

The open green space exceeds the minimum requirement and is well distributed.

- 5) Landscaping: The HWY-1 District requires landscaping at the rate of 0.02 points per sq. ft. of total development site area which comes to 947 points required. Their plan achieves 1670 points. An additional 450 points are required for street tree planting and their plan achieves 520.

Trees are required in the vehicular use area at the rate of one overstory tree per 15 parking spaces. This equates to a requirement of 2 overstory trees. That is the amount proposed within the parking area to meet this requirement.

In addition to parking lot trees, there are trees located along the street frontages, with shrubs and additional trees being located around the buildings and parking areas as required. **Landscaping requirements are met.**



- 6) Building Design: The HWY-1 zone requires a design review of various elements. The intent of the zone is to promote and facilitate comprehensively planned commercial developments located adjacent to major transportation corridors and interchanges. It is further the purpose of the zone to encourage high standards of building architecture and site planning. The elements in the code are noted below with a review on how each is addressed. **Overall, staff finds that the proposed building design meets the zoning standards based on the following analysis.**

Proportion: The relationship between the width and height of the front elevations of adjacent buildings shall be considered in the construction or alteration of a building; the relationship of width to height of windows and doors of adjacent buildings shall be considered in the construction or alteration of a building.

Renderings of the proposed building have been submitted. The scale and proportion of the new building will be similar to other nearby establishments. It is 1-story with variable wall heights where the slanted roof has the highest point (19') facing Viking Road and the lowest point (15' 11") facing Viking Plaza Drive. The neighboring buildings to the east and west have similar dimensions. Staff finds that the proposal is consistent with neighboring buildings and with the height allowances in the zoning district.

Roof shape, pitch, and direction: The similarity or compatibility of the shape, pitch, and direction of roofs in the immediate area shall be considered in the construction or alteration of a building.

The adjacent buildings utilize flat roofs with a parapet around the edge. The roof on the proposed building slants southward but also utilizes a parapet to shield any necessary mechanicals on the roof. With the highest point facing Viking the orientation of the building is similar to the orientation of both Culver's and Cane's (facing or presenting to Viking Road) which both have some variation in roof height but no slant like what is being proposed. That said, the slant is subtle enough and does not appear to be incompatible with the surrounding buildings.

Pattern: Alternating solids and openings (wall to windows and doors) in the front facade and sides and rear of a building create a rhythm observable to viewers. This pattern of solids and openings shall be considered in the construction or alteration of a building.

The new building would present to Viking Road with primarily a transparent window façade and some accents of the other materials. Though set back, the proposed sit-down area and counter should be visible through the windows from the passersby on Viking Road. There is also a good balance of the other materials and colors that provide a transition to the less transparent rear of the building. Overall, the patterns meet or exceed the city's standards.

Materials and texture: Materials and texture. The similarity or compatibility of existing materials and textures on the exterior walls and roofs of buildings in the immediate area shall be considered in the construction or alteration of a building. A building or alteration shall be considered compatible if the materials and texture used are appropriate in the context of other buildings in the immediate area.

Transparent windows, fiber cement siding, and carbon ledge stone veneer with a touch of fiberon composite cladding are the exterior materials proposed for the new building. All of the materials provide a more sleek modern feel that strikes a balance between color and texture. Staff finds that these material and texture choices are compatible with those of adjacent buildings.

Color: The similarity or compatibility of existing colors of exterior walls and roofs of buildings in the area shall be considered in the construction or alteration of a building.

With exception of the red accent awnings, the building features a very neutral color palate. The darker carbon color compliments the transparent windows and the appearance of wood from the fiberon composite cladding emphasizes the transparency on the sides of the building. The fiber cement siding is an inconspicuous gray cobblestone color that blends in with the color scheme. Staff finds no issues with the choice of colors.

Architectural features: Architectural features, including but not limited to, cornices, entablatures, doors, windows, shutters, and fanlights, prevailing in the immediate area, shall be considered in the construction or alteration of a building. It is not intended that the details of existing buildings be duplicated precisely, but those features should be regarded as suggestive of the extent, nature, and scale of details that would be appropriate on new buildings or alterations.

Architectural features of the new building include a slanted shed roof and a unique building shape that utilizes subtle angles to set itself apart. These wake up an otherwise plain building shape. The presentation of windows is similar to buildings in the surrounding development. These style features and materials maintain identity while being generally consistent with neighboring buildings.

View from West:



View from North (Viking Road):

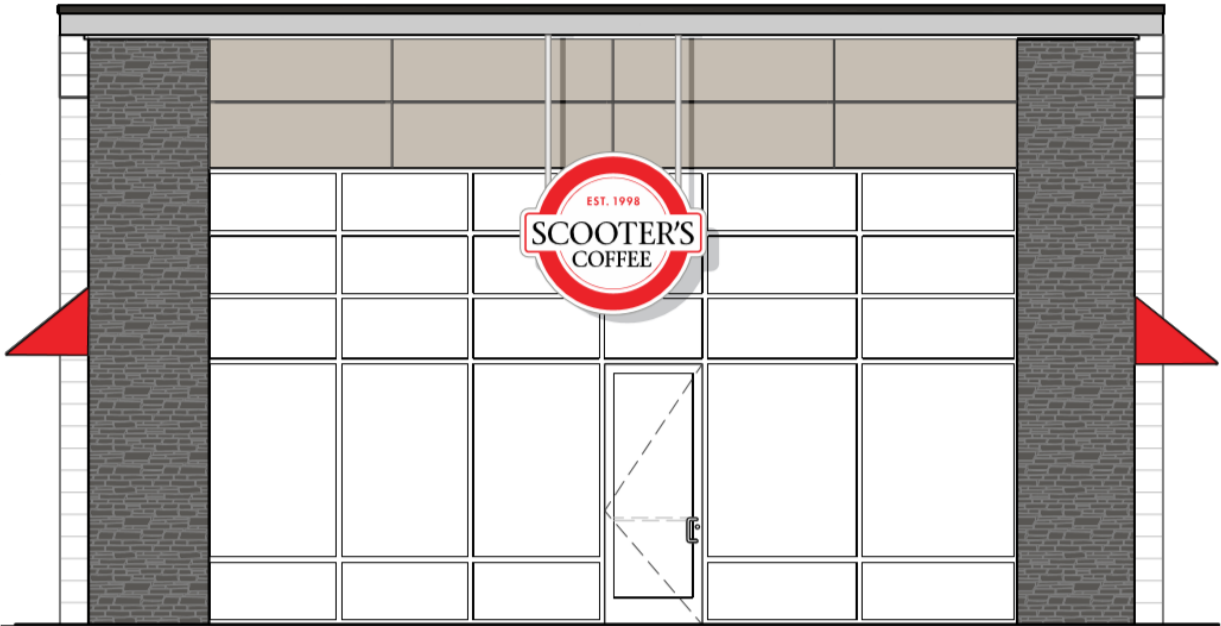

7) Trash Dumpster Site: The dumpster and enclosure is located on the east edge of the property. This enclosure will be made of concrete masonry and siding that will match materials used on the principal structure. It will have two doors to operate towards the west where a truck can approach it. The enclosure will measure 10 feet by 14 feet and will be 6 feet high. **Dumpster facility location and enclosure is acceptable.**

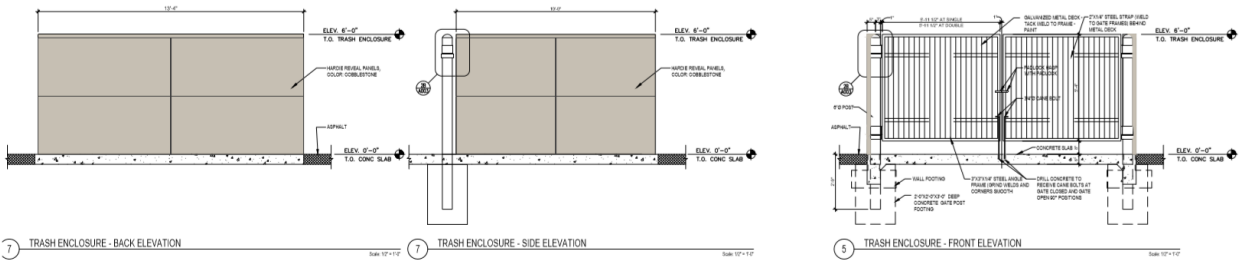

8) Lighting: The HWY-1 District regulations do not have specific lighting design guidelines. However, all new site plans require review of the lighting to consider potential nuisance issues and incompatibilities. The vehicular use area will utilize ten 15-foot high fully downcast and shielded fixtures produced by Lithonia Lighting. Similar fixtures will be used around the building. The lighting plan shows that the proposed models will properly light critical areas of the site without producing glare or spillover light directing light on to other properties. **Lighting is acceptable.**

1) Signage: Separate sign permits will be required for all signage prior to installation. However, the proposed signage plan for the site must be part of this review by the

Planning and Zoning Commission and City Council. The signage plan has been included as an attachment.

Wall signs may only be on two wall surfaces and must be less than 20% of the wall area. For the new building, two wall signs are illustrated on the building on the north and the west. These wall signs meet the quantity and are well within the size requirements.

Freestanding signs are not limited in number but are limited in height to 25 feet above the surface of the roadway and their aggregate sign area should not exceed 250 square feet. The following is a breakdown of freestanding signs with heights and sign areas:

<u>Sign Type</u>	<u>Sign Area (sq ft)</u>	<u>Height (feet)</u>
Monument	50.5	12
Menu Sign	22.5	6.2
Total:	73	

There are also two directional signs. Their height must be less than 6 feet and have a sign area less than 6 square feet. The proposed directional signs meet these requirements.

Signage is acceptable.

- 2) Storm Water Management: The plan directs runoff to the Target basin which was designed to handle this site. The engineering division has determined that no additional detention is required. Prior to construction, a City SWPPP permit will still need to be obtained. **Criterion is met, subject to final engineering review prior to issuance of a building permit.**

TECHNICAL COMMENTS

Cedar Falls Utilities (CFU) has reviewed the Hwy 1 Site Plan for Scooters Coffee. Water, electric, gas, and communications utility services are available in accordance with the service policies of CFU. Water is available along Viking Plaza Drive and natural gas is available along Viking Plaza Drive and Andrea Drive. Gas services are owned, installed and maintained by CFU. If the primary heat source for the new building is natural gas, CFU will install the gas service at no cost to the owner. General contractor must contact CFU for coordination of utility service locations.

Any other minor technical issues will be addressed at the time of building plan review.

A courtesy notice to surrounding property owners was mailed on April 21, 2021.

STAFF RECOMMENDATION

The Community Development Department has reviewed this site plan and recommends approval, subject to the following conditions:

- 1. Developer’s plan must conform to all city staff recommendations and technical requirements.

PLANNING & ZONING COMMISSION

Introduction
Discussion
& Vote
4/28/2021

Attachments: Location Map
 Complete Site Plan Set
 Proposed Signage Plan & Building Elevations
 Lighting Plan

Cedar Falls Planning and Zoning Commission

April 28, 2021

Item 7.

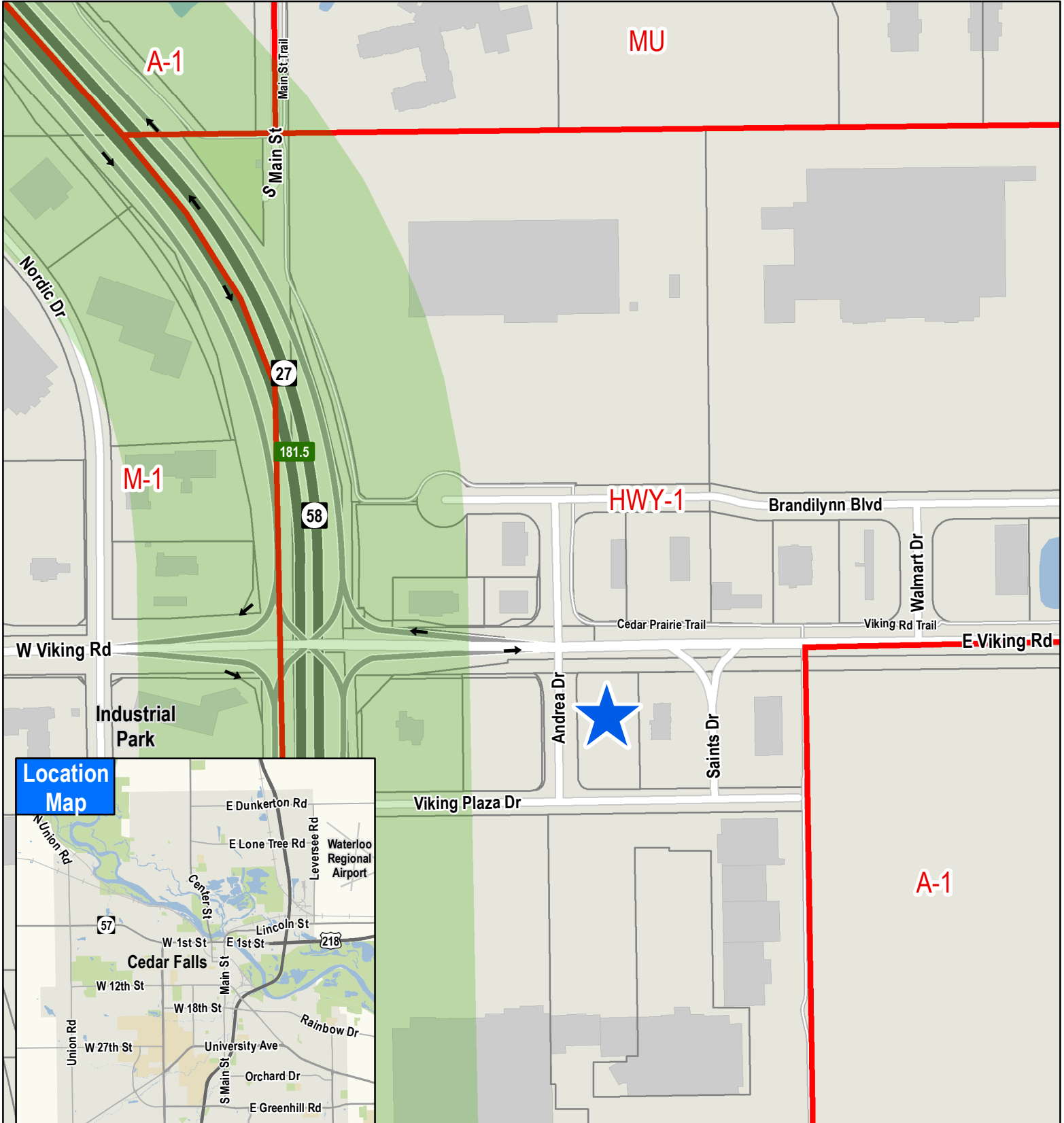

Location Map

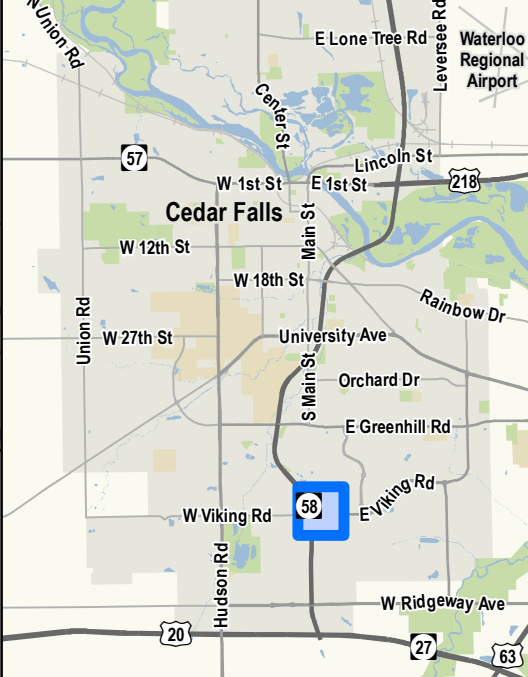

HWY-1 Site Plan for Scooter's Coffee

315 Viking Plaza Drive

SCOOTERS VIKING PLAZA IN THE CITY OF CEDAR FALLS, BLACK HAWK COUNTY, IOWA

NEW COMMERCIAL DEVELOPMENT

PN: 4290-20

INDEX OF SHEETS

SHEET	TITLE
C0.1	TITLE
C0.2	SITE DEVELOPMENT PLAN
C0.3	GENERAL NOTES AND SUPPLEMENTAL DETAILS
C1.1	UTILITY PLAN
C2.1	PAVING PLAN – SOUTH
C2.2	PAVING PLAN – NORTH
C3.1	SWPPP – INITIAL
C3.2	SWPPP – CONSTRUCTION
C3.3	SWPPP – FINAL STABILIZATION
C4.1	LANDSCAPE PLAN

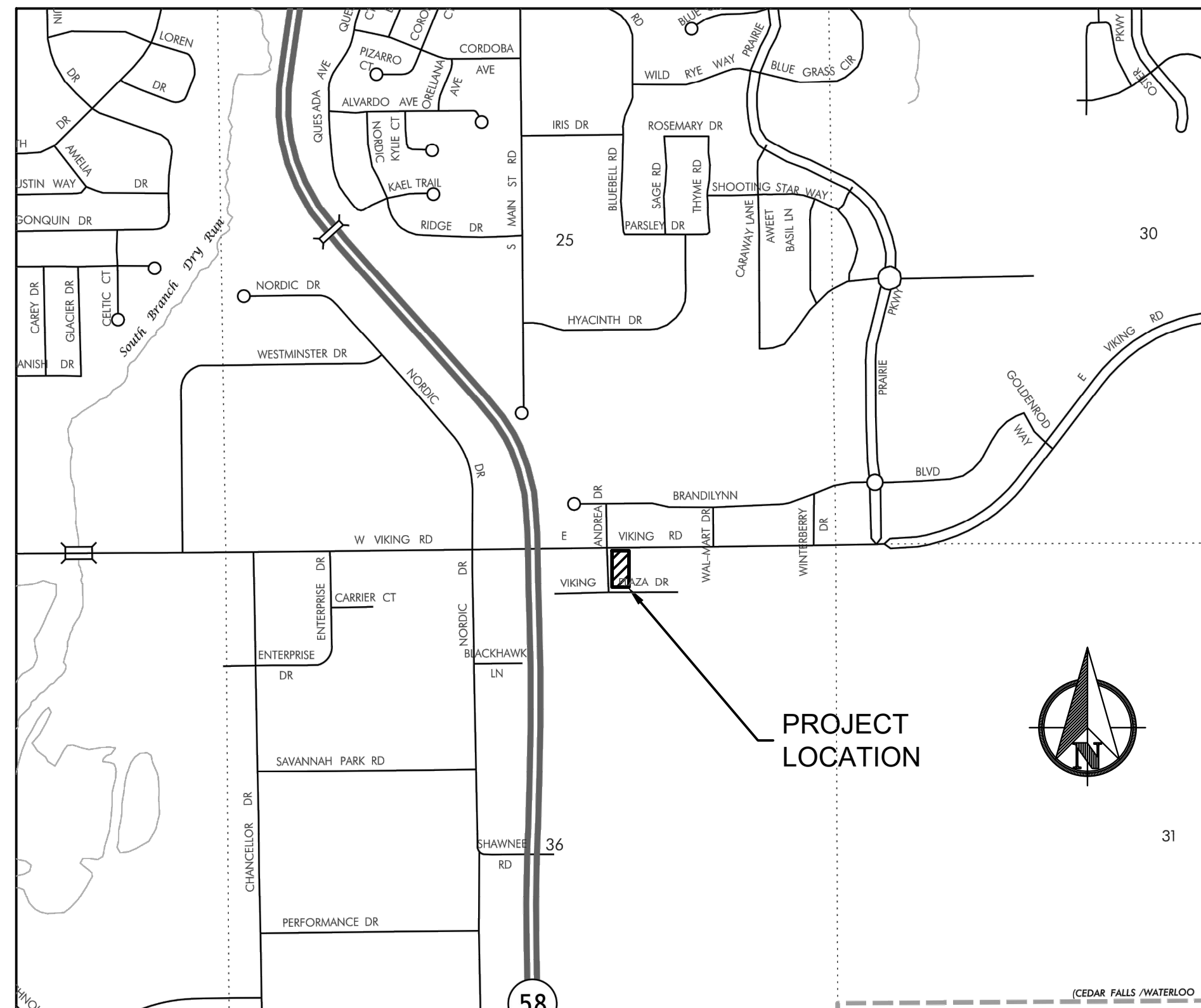
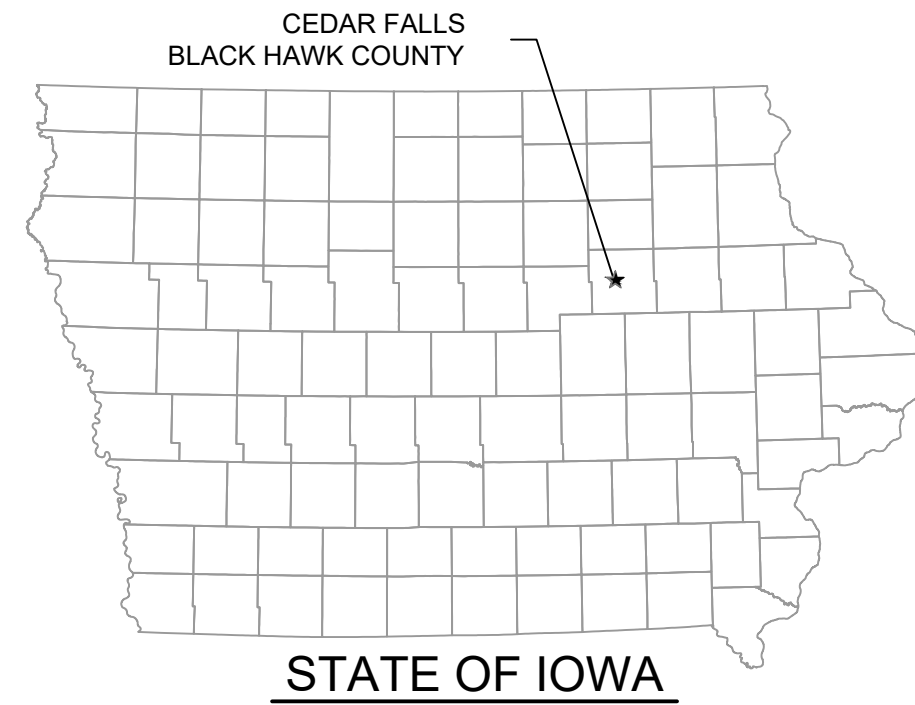

LOCATION MAP
CEDAR FALLS, IOWA
NTS



THE SITE IMPROVEMENTS SHOWN WITHIN THIS PLAN SHALL BE CONSTRUCTED IN CONFORMANCE WITH THE 2021 VERSION OF THE URBAN STANDARD SPECIFICATIONS FOR PUBLIC IMPROVEMENTS, ALSO KNOWN AS SUDAS (2021), AS AMENDED BY THE CITY OF CEDAR FALLS, AND, IF PROVIDED, PROJECT SPECIFIC SUPPLEMENTAL SPECIFICATIONS.

DEVELOPER
B3 BREW, LLC
306 MAIN AVENUE
CLEAR LAKE, IOWA 50428

GENERAL CONTRACTOR
HUFF CONTRACTING
1310 GRANDVIEW AVENUE
WATERLOO, IOWA 50703
319.233.9000

CIVIL ENGINEER
ROBINSON ENGINEERING
819 SECOND STREET NE
INDEPENDENCE, IOWA 50644
319-334-7211
PROJECT CONTACT: ALEX BOWER
ENGINEER: MONICA SMITH

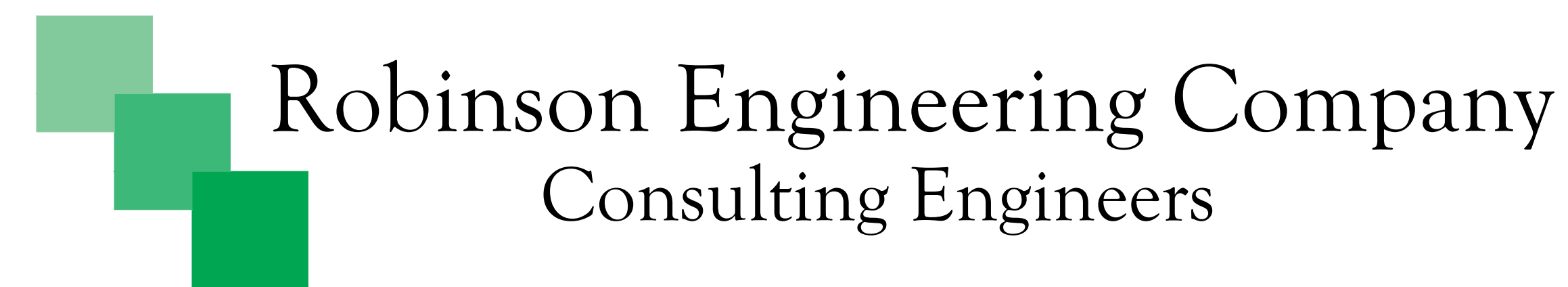

Robinson Engineering Company
Consulting Engineers

819 Second Street NE
Independence, Iowa 50644
319-334-7211

C0.1
3/28/2021
SUBMITTAL 3

	I hereby certify that this Engineering document was prepared by me or under my direct personal supervision and that I am a duly Licensed Professional Engineer under the laws of the State of Iowa.	
	MONICA M. SMITH	LICENSE NO. 15074
	Signature _____	Date _____
	My renewal date is <u>December 31, 2021</u>	
Pages or sheets covered by this seal: 'C' SHEETS		

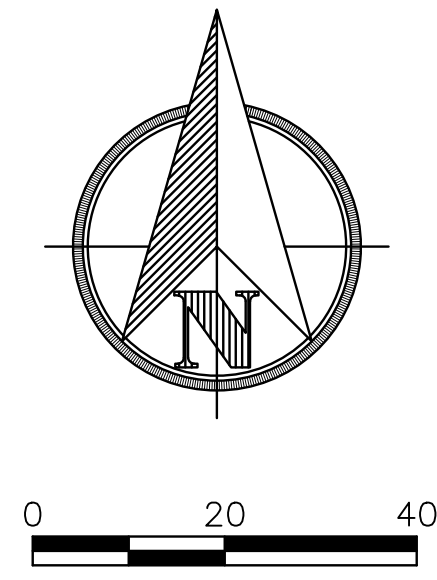
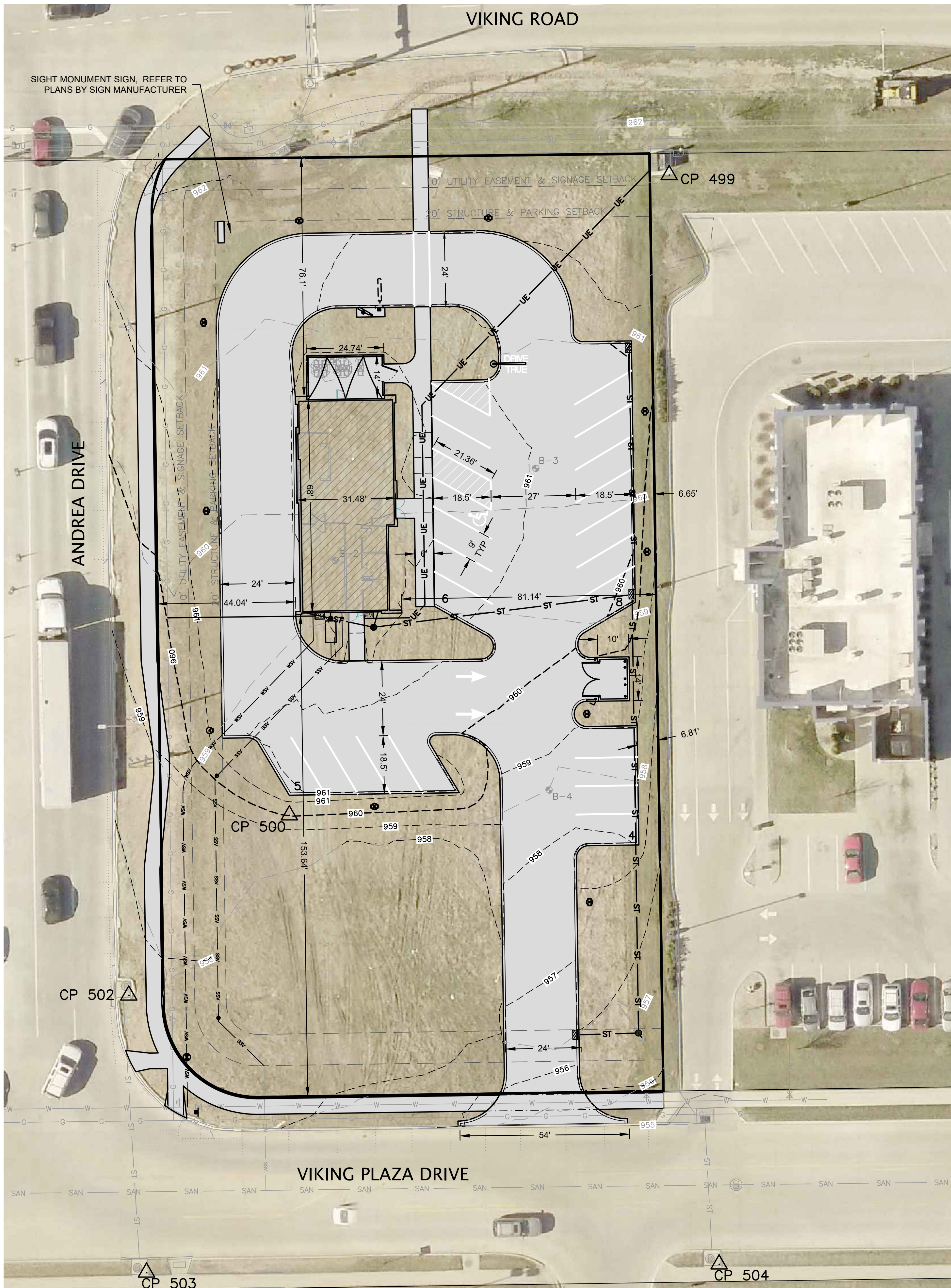

**SITE DEVELOPMENT PLAN
SCOOTERS VIKING PLAZA**

SITE ADDRESS - 315 VIKING PLAZA DRIVE
LOT 3, EAST VIKING PLAZA ADDITION
PARCEL ID 8914-36-202-001

OWNER
B3 BREW, LLC
306 MAIN AVENUE
CLEAR LAKE, IOWA 50428

ZONING: HWY-1 - HIGHWAY COMMERCIAL

LOT INFORMATION
LOT SIZE: 47,350 S.F. / 1.087 ACRES

SETBACK REQUIREMENTS (ALSO APPLIES TO PARKING)
FRONT: 20'
REAR: NOT NOTED
SIDE: NOT NOTED

BUILDING AND LOT USE
EXISTING
BUILDING FOOTPRINT: N/A
TOTAL PAVEMENT & SIDEWALKS: N/A
TOTAL VEGETATED SURFACE: 47,350 S.F. (100%)
PROPOSED (WITHIN LOT, 47,350 SF)
BUILDING FOOTPRINT: 2,064 S.F. (4.3%)
TOTAL PAVEMENT & SIDEWALKS: 20,257 S.F. (42.8%)
TOTAL VEGETATED SURFACE: 25,029 S.F. (52.9%)
PROPOSED (WITHIN LANDSCAPE SETBACK, 35,999 SF)
BUILDING FOOTPRINT: 2,064 S.F. (5.7%)
TOTAL PAVEMENT & SIDEWALKS: 19,506 S.F. (54.2%)
TOTAL VEGETATED SURFACE: 14,429 S.F. (40.1%)

PARKING
REQUIRED
30. Restaurant, fast food, drive-in or carryout. One parking space for every 100 square feet of gross floor area, plus one parking space for every two employees with a minimum of five parking spaces for employee parking. Where drive-up window facilities are proposed, five stacking spaces shall be provided per window.

CALCULATIONS:
TOTAL FLOOR AREA = 1,927 SF
(RESTROOMS, STORAGE, VESTIBULE = 285 SF. THE MAXIMUM REDUCTION OF 10% = 192 SF. 1,735 SF USED FOR PARKING CALCS)
GROSS FLOOR AREA FOR PARKING CALCULATIONS = 1,735 SF
FLOOR AREA 15 SPACES (1,735/100 = 18)
EMPLOYEES 5 SPACES (5 EMPLOYEES, USE MINIMUM)
TOTAL 23 SPACES
PROVIDED PARKING: 23 SPACES

PROPOSED EMPLOYEES (MAX SHIFT PROJECTED): 5

FLOOD PLAIN - N/A

STORM WATER MANAGEMENT - REGIONAL

Robinson Engineering Company
Consulting Engineers

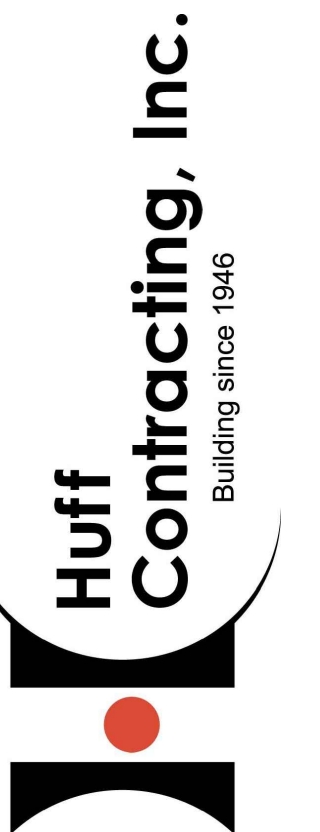

SITE DEVELOPMENT PLAN

SCOOTERS VIKING PLAZA
PN 4290-20
B3 BREW, LLC
306 MAIN AVENUE
CLEAR LAKE, IOWA 50428

C0.2

3/28/2021
SUBMITTAL 3

PROJECT CONTROL

CP 499	N-3641152.03, E-5206484.03, Z-962.15	MAG NAIL
CP 500	N-3640947.92, E-5206362.88, Z-958.36	1/2" REBAR
CP 502	N-3640890.50, E-5206311.66, Z-957.65	MAG NAIL
CP 503	N-3640802.18, E-5206317.31, Z-958.06	MAG NAIL
CP 504	N-3640804.76, E-5206499.95, Z-955.58	MAG NAIL

GENERAL NOTES

1. ALL WORK SHALL CONFORM TO AND BE PERFORMED IN ACCORDANCE WITH ALL APPLICABLE CODES AND ORDINANCES.
2. THE SITE IMPROVEMENTS SHOWN WITHIN THIS PLAN SHALL BE CONSTRUCTED IN CONFORMANCE WITH THE 2021 VERSION OF THE URBAN STANDARD SPECIFICATIONS FOR PUBLIC IMPROVEMENTS, ALSO KNOWN AS SUDAS (2021) AS AMMENDED BY THE CITY OF CEDAR FALLS UNLESS SPECIFICALLY STATED OTHERWISE IN THESE PLANS, THE PROJECT MANUAL (IF APPLICABLE), OR CITY AND OTHER APPLICABLE ORDINANCES. THIS INCLUDES, IF PROVIDED, PROJECT SPECIFIC SUPPLEMENTAL SPECIFICATIONS.
3. ANY QUANTITIES SHOWN ON THE CIVIL SHEETS (C#.#) ARE TO ASSIST THE BIDDER. THE BIDDER/CONTRACTOR SHALL MAKE A FINAL DETERMINATION OF THE QUANTITIES REQUIRED TO COMPLETE THE WORK AND THE BID SHALL BE ON THE BASIS OF THE BIDDER/CONTRACTOR'S OWN CALCULATIONS. ANY COMMENT RELATED TO QUANTITY OR PAYMENT ON THE CIVIL SHEETS IS SOLELY PROVIDED TO ASSIST THE BIDDER/CONTRACTOR IN THE PREPARATION OF BIDDING AND SHALL NOT BE CAUSE FOR CHANGE ORDER REQUEST.
4. CONSTRUCTION SURVEY FOR THIS PROJECT SHALL BE PROVIDED BY THE CONTRACTOR.
5. THE CONTRACTOR SHALL NOTIFY ALL APPROPRIATE ENGINEERING DEPARTMENTS AND UTILITY COMPANIES PRIOR TO CONSTRUCTION. ALL NECESSARY PRECAUTIONS SHALL BE TAKEN TO AVOID DAMAGE TO ANY EXISTING UTILITY. IOWA CODE 480, UNDERGROUND FACILITIES INFORMATION, REQUIRES NOTICE TO IOWA ONE CALL (1-800-292-8989) NOT LESS THAN 48 HOURS BEFORE EXCAVATION, EXCLUDING WEEKENDS AND LEGAL HOLIDAYS.
6. THE LOCATION OF EXISTING UNDERGROUND UTILITIES AND ARE SHOWN IN AN APPROXIMATE WAY ONLY AND HAVE NOT BEEN INDEPENDENTLY VERIFIED BY THE OWNER OR ITS REPRESENTATIVE. THE CONTRACTOR SHALL, AT ITS OWN EXPENSE, LOCATE AND DETERMINE THE UNDERGROUND UTILITIES ON THE PROJECT SITE. THE CONTRACTOR ASSUMES RESPONSIBILITY FOR ANY AND ALL DAMAGES WHICH MIGHT OCCUR BY THE CONTRACTOR'S FAILURE TO LOCATE AND PRESERVE ANY UNDERGROUND UTILITIES.
7. THE CONTRACTOR SHALL VISIT THE PROJECT SITE PRIOR TO BIDDING TO BECOME FULLY FAMILIAR WITH THE EXISTING CONDITIONS OF THE SITE. FAILURE TO VISIT THE SITE SHALL NOT RELIEVE THE CONTRACTOR FROM PERFORMING THE WORK IN ACCORDANCE WITH THESE DRAWINGS.
8. THE CONTRACTOR SHALL VERIFY AT THE SITE, ALL DIMENSIONS AND CONDITIONS SHOWN ON THE DRAWINGS, AND SHALL NOTIFY THE ENGINEER OF ANY DISCREPANCIES, OMISSIONS, AND/OR CONFLICT PRIOR TO PROCEEDING WITH THE WORK.
9. DRAWING DIMENSIONS SHALL GOVERN OVER SCALING OF DRAWINGS. LARGE SCALE DRAWINGS SHALL GOVERN OVER SMALL SCALE DRAWINGS. NOTES AND DETAILS ON THE DRAWINGS SHALL APPLY TO ALL SIMILAR CONDITIONS WHETHER THEY ARE REPEATED OR NOT.
10. THE CONTRACTOR SHALL BE RESPONSIBLE FOR ANY DAMAGE TO EXISTING FACILITIES OUTSIDE THE CONSTRUCTION LIMITS RESULTING FROM NEGLIGENCE.
11. CONTRACTOR SHALL PROTECT EXISTING FACILITIES, BUILDINGS, AND OTHER APPURTENANCES NOT TO BE REMOVED FROM THE SITE DURING THE CONSTRUCTION ACTIVITIES.
12. CONTRACTOR SHALL CONFINE WORK TO THE CONSTRUCTION LIMITS AND EASEMENTS PROVIDED OR EASEMENTS OBTAINED. COPIES OF ANY EASEMENTS THE CONTRACTOR OBTAINS FOR CONSTRUCTION WORK ON THIS PROJECT SHALL BE PROVIDED TO THE OWNER.
13. CONTRACTOR SHALL COORDINATE TEMPORARY DISRUPTION OF UTILITY SERVICES WITH THE CITY OF CEDAR FALLS, AFFECTED UTILITY COMPANIES, AND/OR AFFECTED PROPERTY OWNERS WHEN UTILITY SERVICES ARE INTERRUPTED DUE TO CONSTRUCTION ACTIVITIES ON THIS PROJECT.
14. TYPE A COMPACTION SHALL BE REQUIRED FOR EXCAVATION/EMBANKMENT WORK ON THIS PROJECT. ADDITIONAL COMPACTION REQUIREMENTS MAY BE REQUIRED FOR BUILDING CONSTRUCTION. REFER TO APPLICABLE SPECIFICATIONS FOR THAT WORK.
15. THIS PLAN REFERENCES NYLOPLAST STRUCTURES WITH THE INTENT TO SPECIFY AN ENGINEERED PVC STRUCTURE AND IS NOT INTENDED TO INDICATE A SPECIFIC BRAND IS REQUIRED. STRUCTURES SHALL BE NYLOPLAST BRAND OR EQUIVALENT. NYLOPLAST IS A BRAND NAME AFFILIATED WITH ADS PIPE.

Robinson Engineering Company
Consulting Engineers



819 Second Street NE
Independence, Iowa 50644
319.394.7211

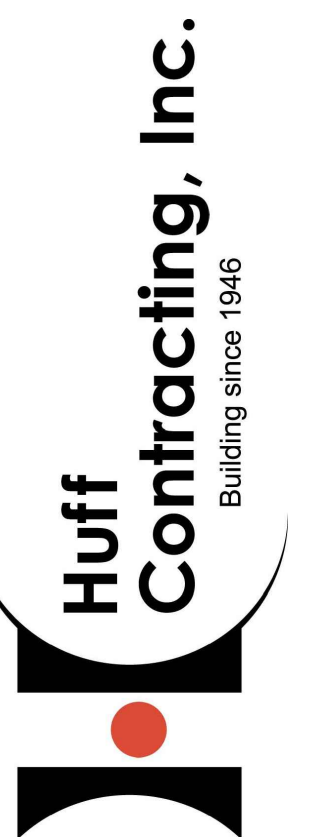

GENERAL NOTES AND
SUPPLEMENTAL DETAILS

SCOOTERS VIKING PLAZA
PO 4290-20
B3 BREW, LLC
306 MAIN AVENUE
CLEAR LAKE, IOWA 50428

C0.3

3/28/2021
SUBMITTAL 3

VIKING ROAD

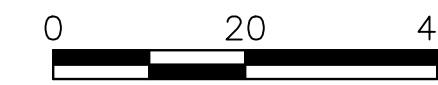
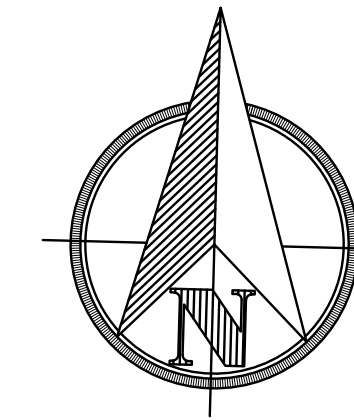

SIGHT MONUMENT SIGN, REFER TO PLANS BY SIGN MANUFACTURER

ANDREA DRIVE

PLACE RADIUS NO SMALLER THAN MANUFACTURE'S SPECIFICATIONS

LIGHT POLE, TYPICAL

TRAFFIC SIGNAGE, DO NOT DISTURB

VIKING PLAZA DRIVE

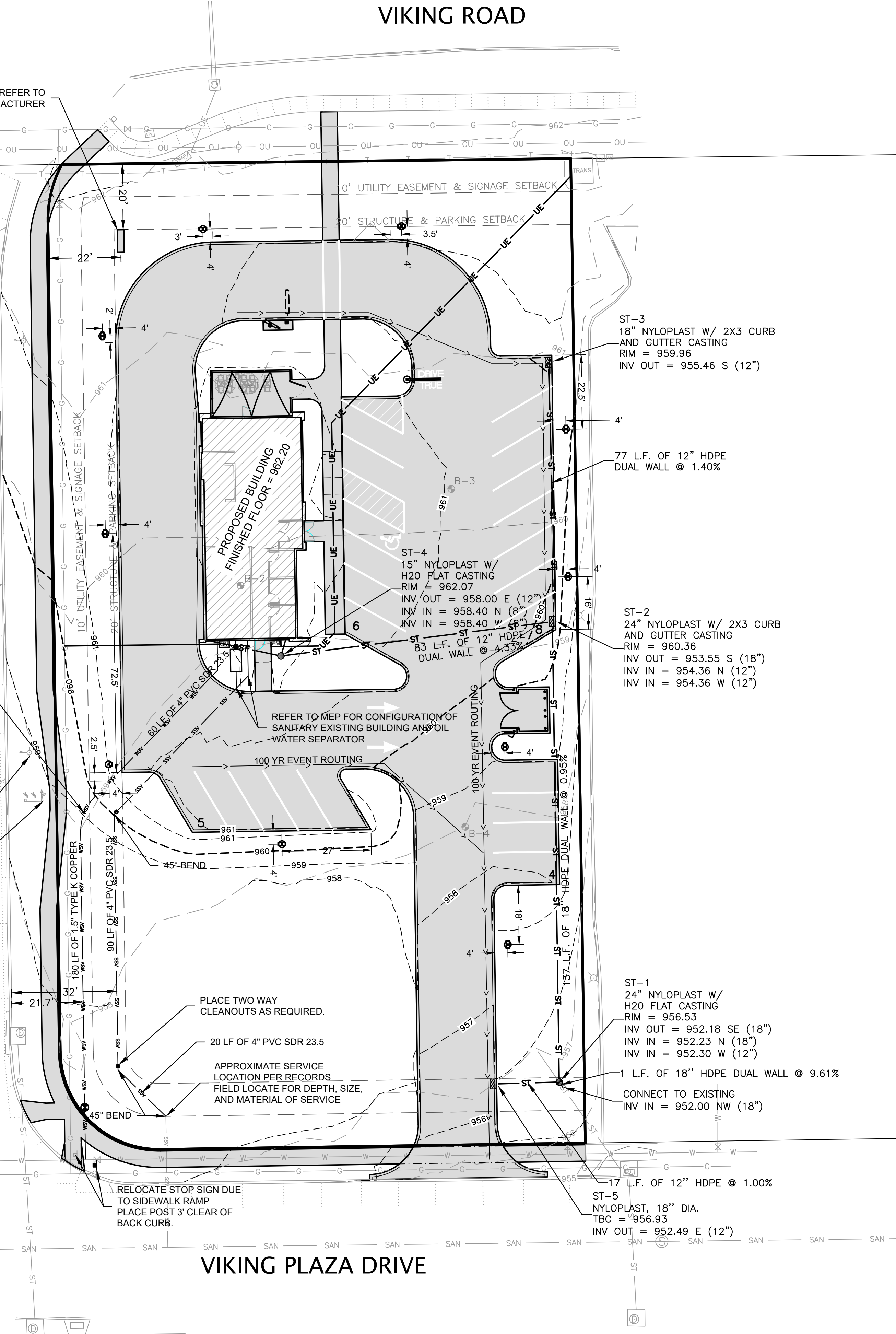

STORM PIPE LEGEND

- ST — ST — NON PERFORATED STORM PIPE
- DT — DT — PERFORATED STORM PIPE

NOTES:

1. ALL HDPE DRAINAGE PIPE SHALL BE OF DUAL WALL CONSTRUCTION. REFER TO PIPE LINETYPE LEGEND THIS SHEET FOR WHICH PIPES TO BE PERFORATED, IF ANY.
2. WATER LINE SHALL BE BURIED TO MAINTAIN 6" COVER.
3. CONTRACTOR SHALL FIELD VERIFY LOCATION, ELEVATION, AND MATERIAL OF ALL WATER, STORM, AND SANITARY CONNECTIONS.
4. CONFIRM WATER SERVICE ENTRANCE LOCATION TO BUILDING WITH ARCHITECTURAL AND MECHANICAL PLANS.
5. COORDINATE CONNECTION TO MUNICIPAL WATER MAIN WITH CEDAR FALLS UTILITIES STAFF
6. SANITARY SERVICE SHALL BE INSTALLED WITH TRACER WIRE
7. PLACE LIGHT POLES 3' CLEAR FROM EDGE PAVING/BACK OF CURB

Robinson Engineering Company
Consulting Engineers



Huff Contracting, Inc.
Building since 1946

UTILITY PLAN

SCOOTERS VIKING PLAZA
PW 4290-20
B3 BREW, LLC
306 MAIN AVENUE
CLEAR LAKE, IOWA 50428

C1.1
3/28/2021
SUBMITTAL 3

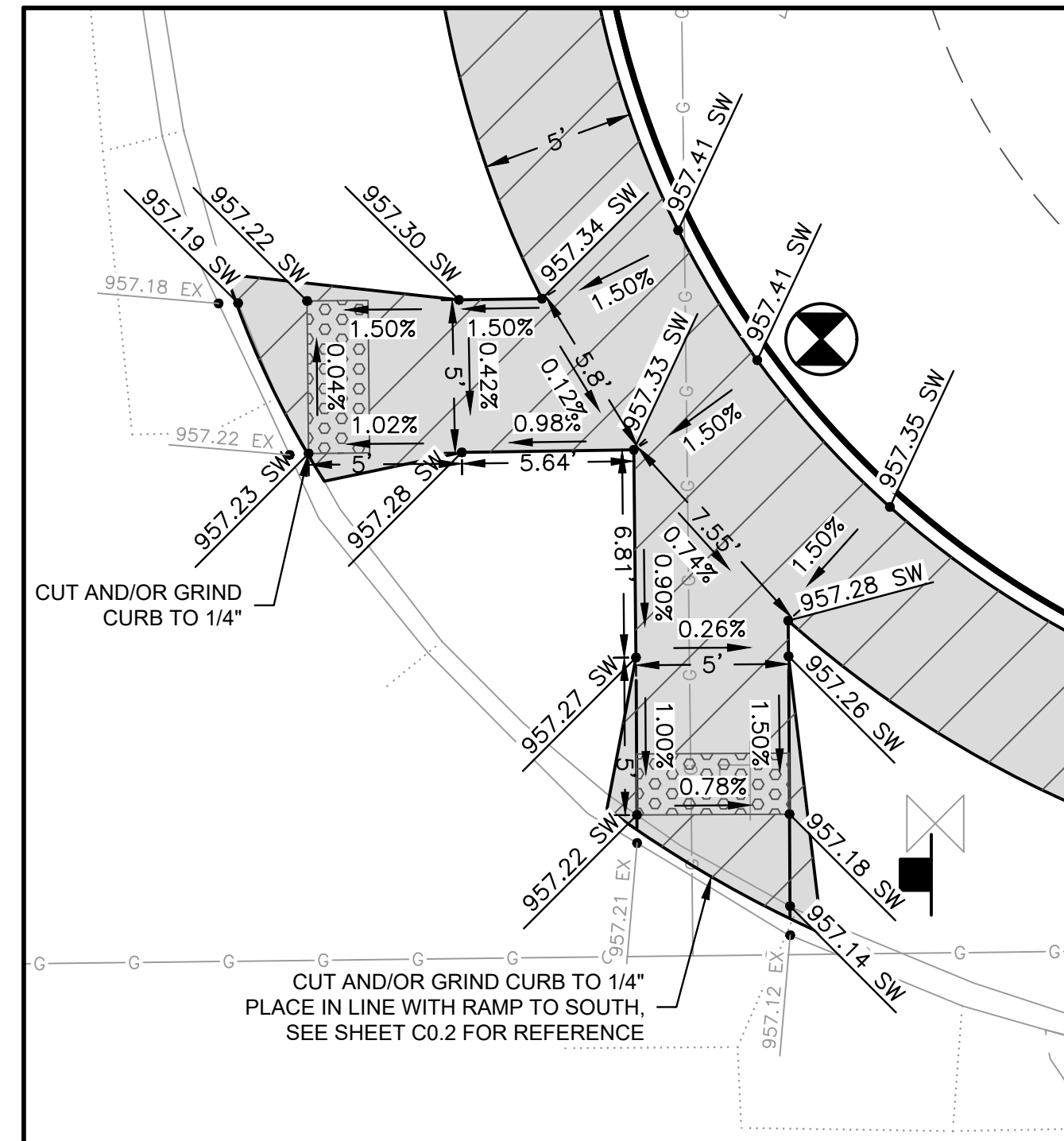
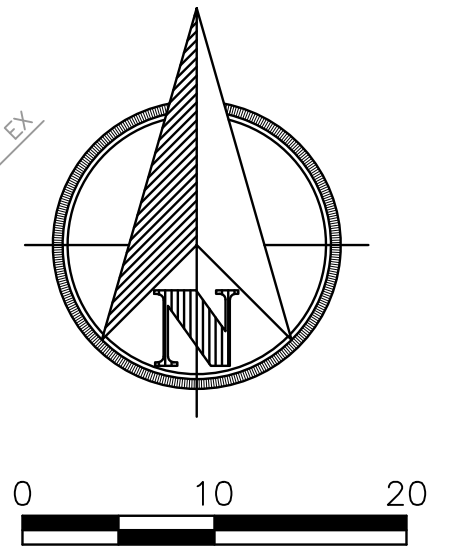
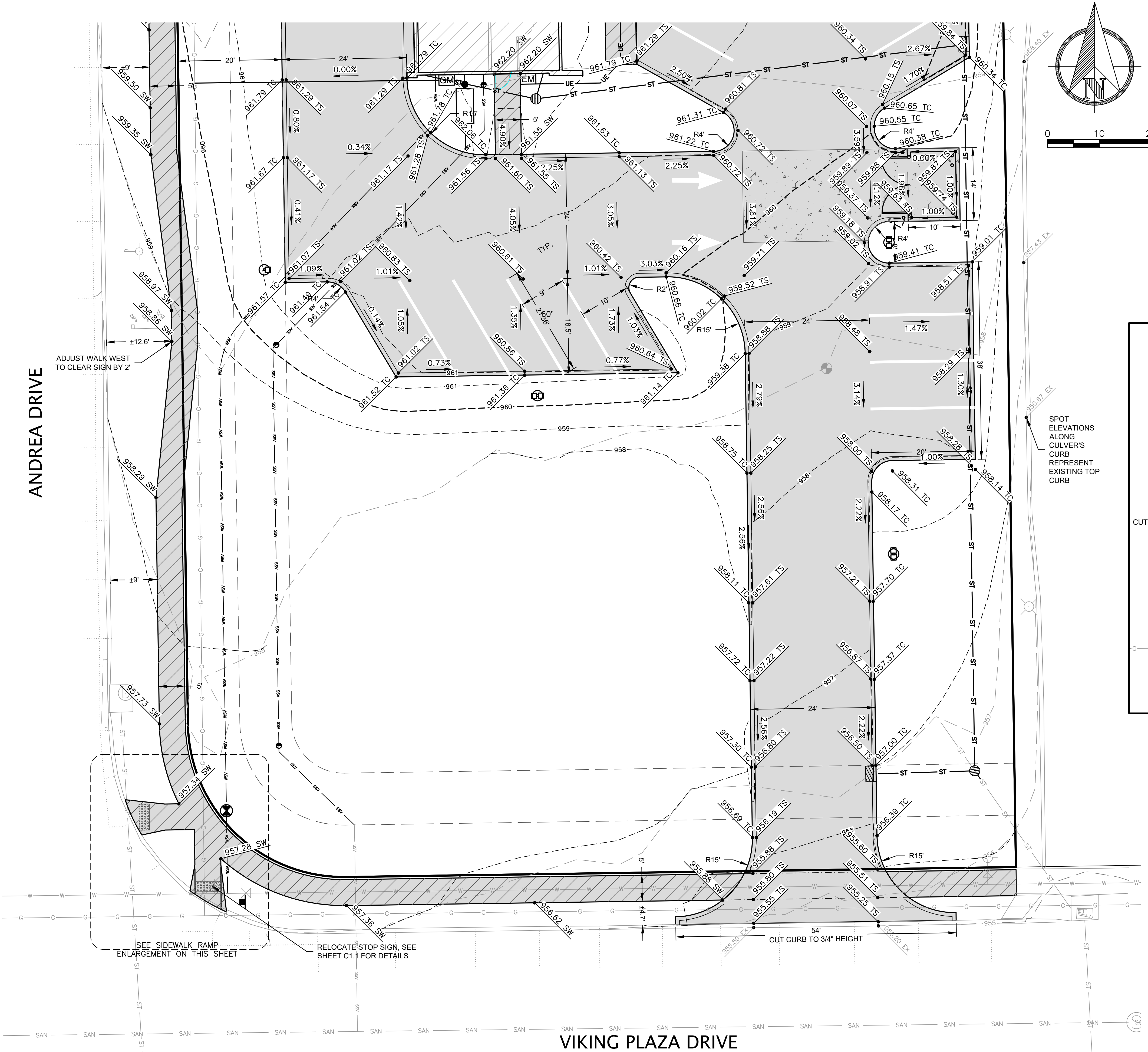

SIDEWALK RAMP ENLARGEMENT

HATCHING LEGEND

- PCC SIDEWALK, 5" PCC ON 4" MODIFIED SUBBASE
- PCC PAVEMENT, 6" PCC ON 6" MODIFIED SUBBASE
- PCC PAVEMENT, 8" PCC ON 6" MODIFIED SUBBASE

PAVEMENT NOTES:

1. SIDEWALKS ARE DESIGNED AT 1.5% CROSS SLOPE OR LESS. AS CONSTRUCTED CROSS SLOPS SHALL NOT EXCEED 2%.
2. LONGITUDINAL SLOPE OF WALKS SHALL NOT EXCEED 5% (1:20) UNLESS AT CURB RAMPS IN WHICH CASE THE LONGITUDINAL SLOPE SHALL NOT EXCEED 8.3% (1:12). CARE SHALL BE TAKEN TO INSTALL WALKS IN ACCORDANCE WITH THE SURFACE DESIGN HEREIN.
3. END STALLS ARE 10' WIDE MEASURED FROM BACK OF CURB TO CENTER PAVEMENT MARKING. STANDARD STALLS ARE 9' WIDE MEASURED CENTER TO CENTER OF PAVEMENT MARKING. HANDICAP STALLS ARE AS NOTED.
4. PROVIDE AND INSTALL HANDICAP PARKING SIGNS. SIGNS SHALL BE ALUMINUM ON GALVANIZED STEEL SQUARE TUBE.

VIKING PLAZA DRIVE

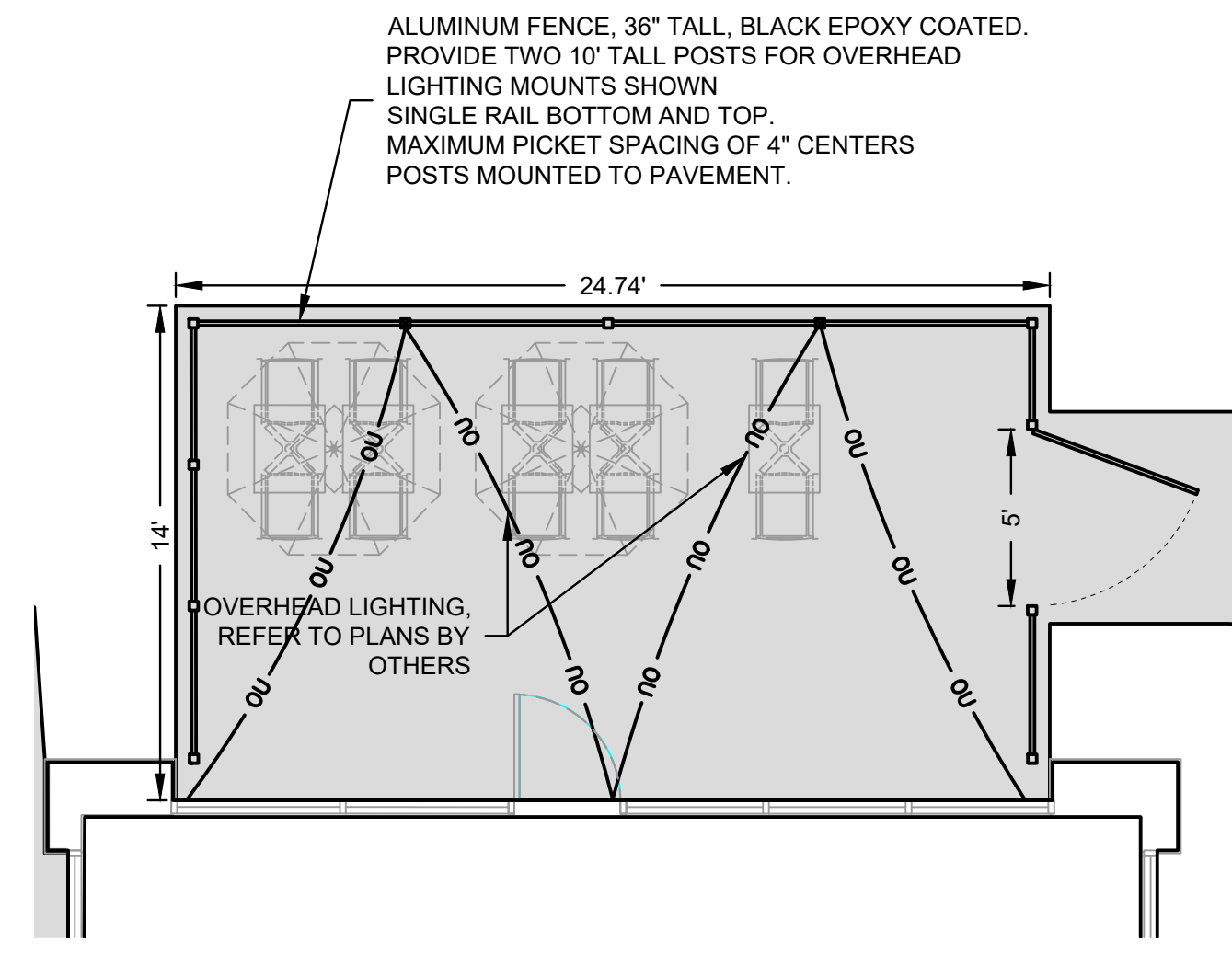
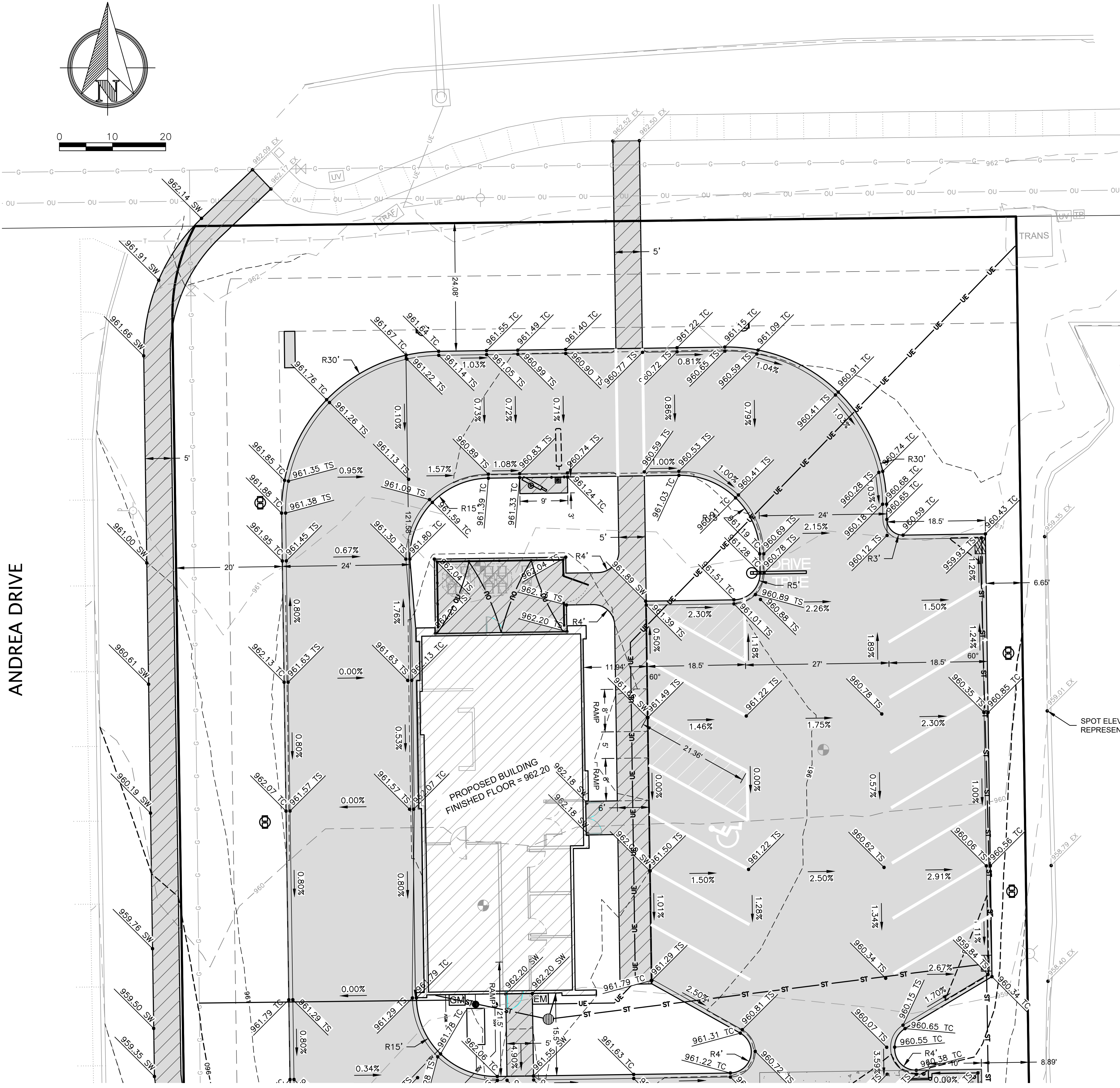
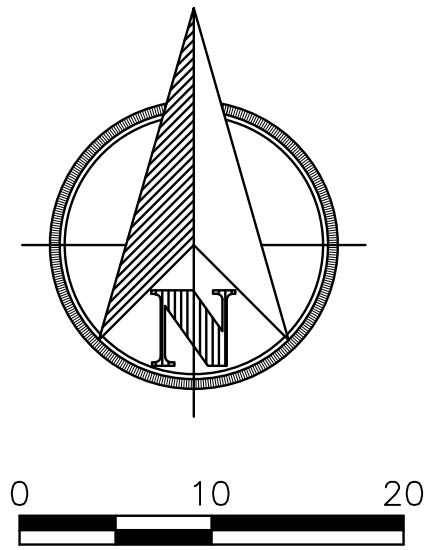

SPOT ELEVATIONS ALONG CULVERS CURB REPRESENT EXISTING TOP CURB

HATCHING LEGEND

- PCC SIDEWALK, 5" PCC ON 4" MODIFIED SUBBASE
- PCC PAVEMENT, 6" PCC ON 6" MODIFIED SUBBASE
- PCC PAVEMENT, 8" PCC ON 6" MODIFIED SUBBASE

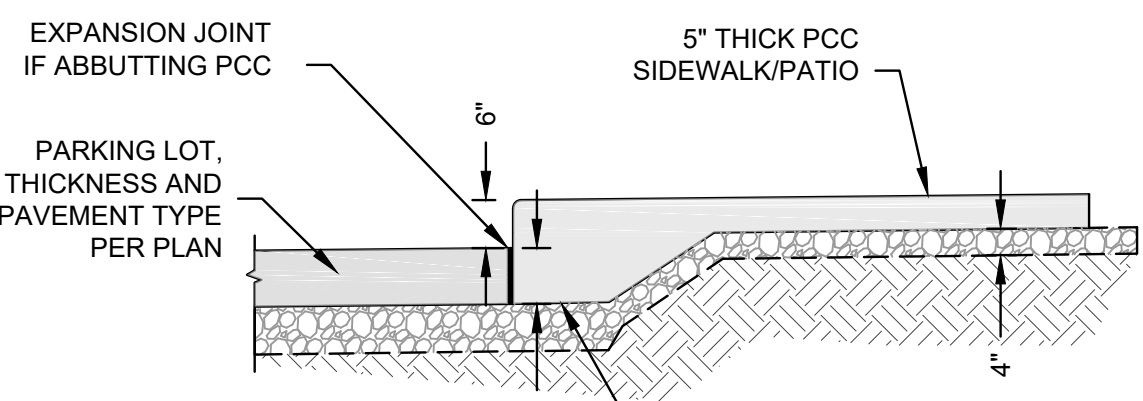

NOTE: REFER TO AND COMPLY WITH IOWA SUDAS 7030.202 FOR CLASS A SIDEWALK DETAILS

CLASS A SIDEWALK SECTION

Robinson Engineering Company
Consulting Engineers



PAVING PLAN - NORTH

SCOOTERS VIKING PLAZA
PN 4290-20
B3 BREW, LLC
306 MAIN AVENUE
CLEAR LAKE, IOWA 50428

C2.2
2021-04-22
SUBMITTAL 3

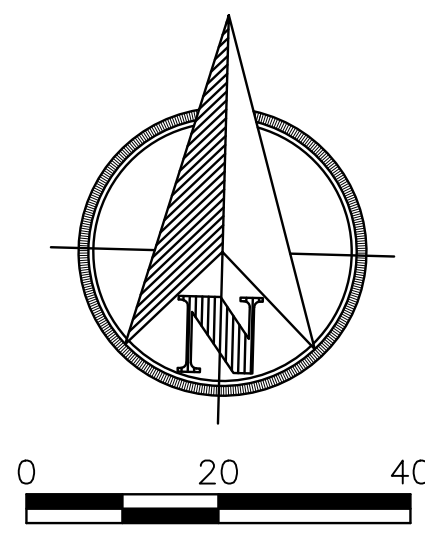
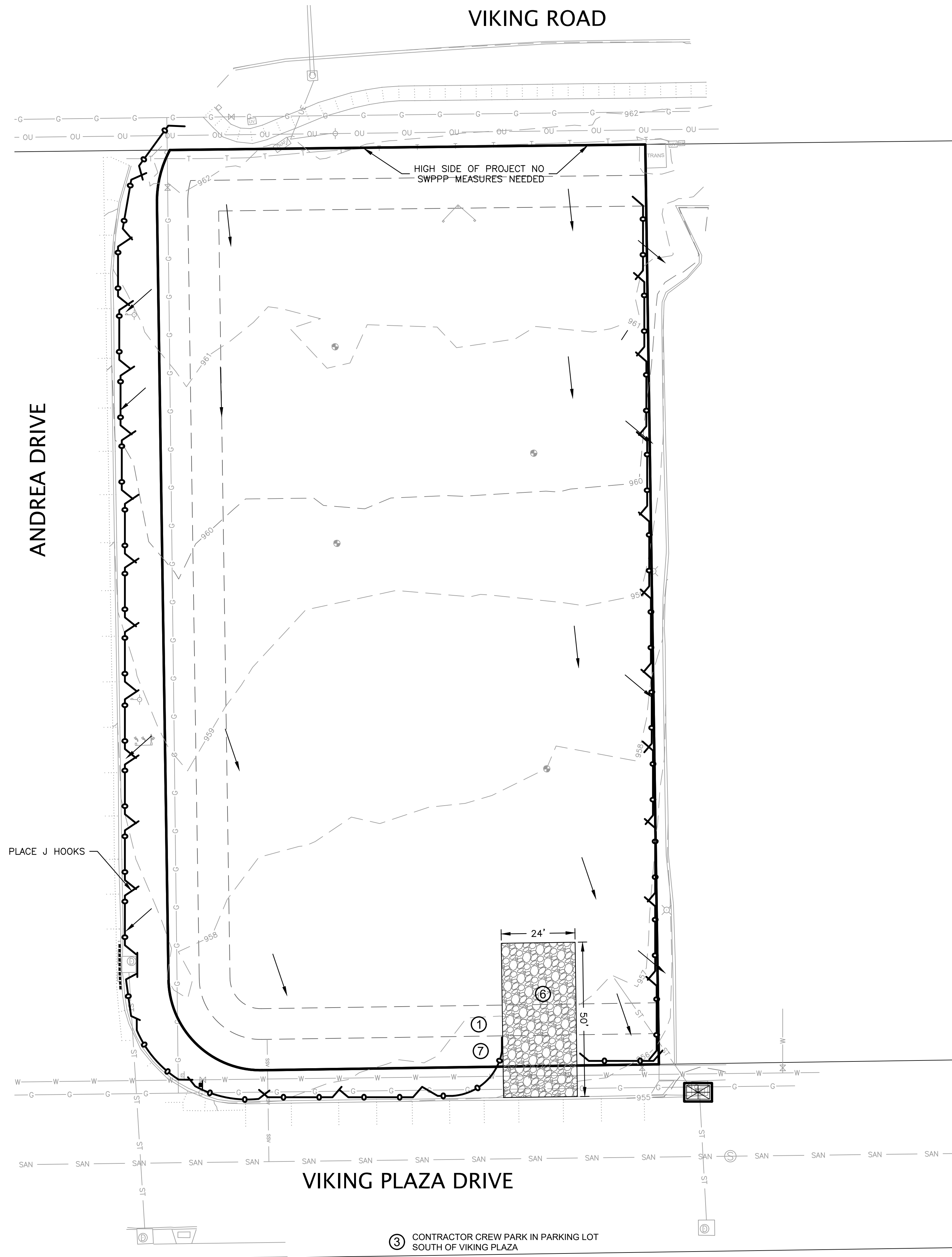

KEY

- ① PORTABLE SANITARY FACILITY
- ② CONSTRUCTION DUMPSTER
- ③ CONSTRUCTION PARKING
- ④ CONSTRUCTION TRAILER
- ⑤ MATERIAL STORAGE
- ⑥ STABILIZED CONSTRUCTION ENTRANCE COMPLY WITH SUDAS 9040.12
- ⑦ CONCRETE WASHOUT

LEGEND

- PCC
 - TOPSOIL, SEEDING, AND MULCHING (MAY INCLUDE LANDSCAPING, REFER TO LANDSCAPING PLAN)
 - GRANULAR SURFACING PERMANENT OR TEMPORARY
 - EROSION MULCHING
 - TEMPORARY ROLLED EROSION CONTROL PRODUCT
 - INLET PROTECTION - SILT BAG
 - INLET PROTECTION - SOCK
 - 9" - FILTER SOCK, MULCH FILL**
 - SILT FENCE
- ** MAY SUBSTITUTE WITH SILT FENCE OR MULCH BERM WHERE PERMITTED

NOTES:

1. NOT ALL KEY AND/OR LEGEND ITEMS MAY BE USED AND SHOWN ON THIS PLAN. THEY ARE AVAILABLE FOR USE IF NEEDED.
2. PORTABLE SANITARY FACILITY SHALL BE STAKED DOWN TO WITHSTAND ANY ANTICIPATED WINDS
3. CONCRETE SLURRY GENERATED BY WET SAWING SHALL BE VACUUMED OR UTILIZE OTHER ACCEPTABLE CONTAINMENT METHOD TO CAPTURE AND DISPOSE OF THE MATERIAL IN ACCORDANCE WITH APPLICABLE LAWS.

Robinson Engineering Company
Consulting Engineers



Huff
Contracting, Inc.
Building since 1946

SWPPP - INITIAL

SCOOTER'S VIKING PLAZA
PN 4290-20
B3 BREW, LLC
306 MAIN AVENUE
CLEAR LAKE, IOWA 50428

C3.1
3/28/2021
SUBMITTAL 3

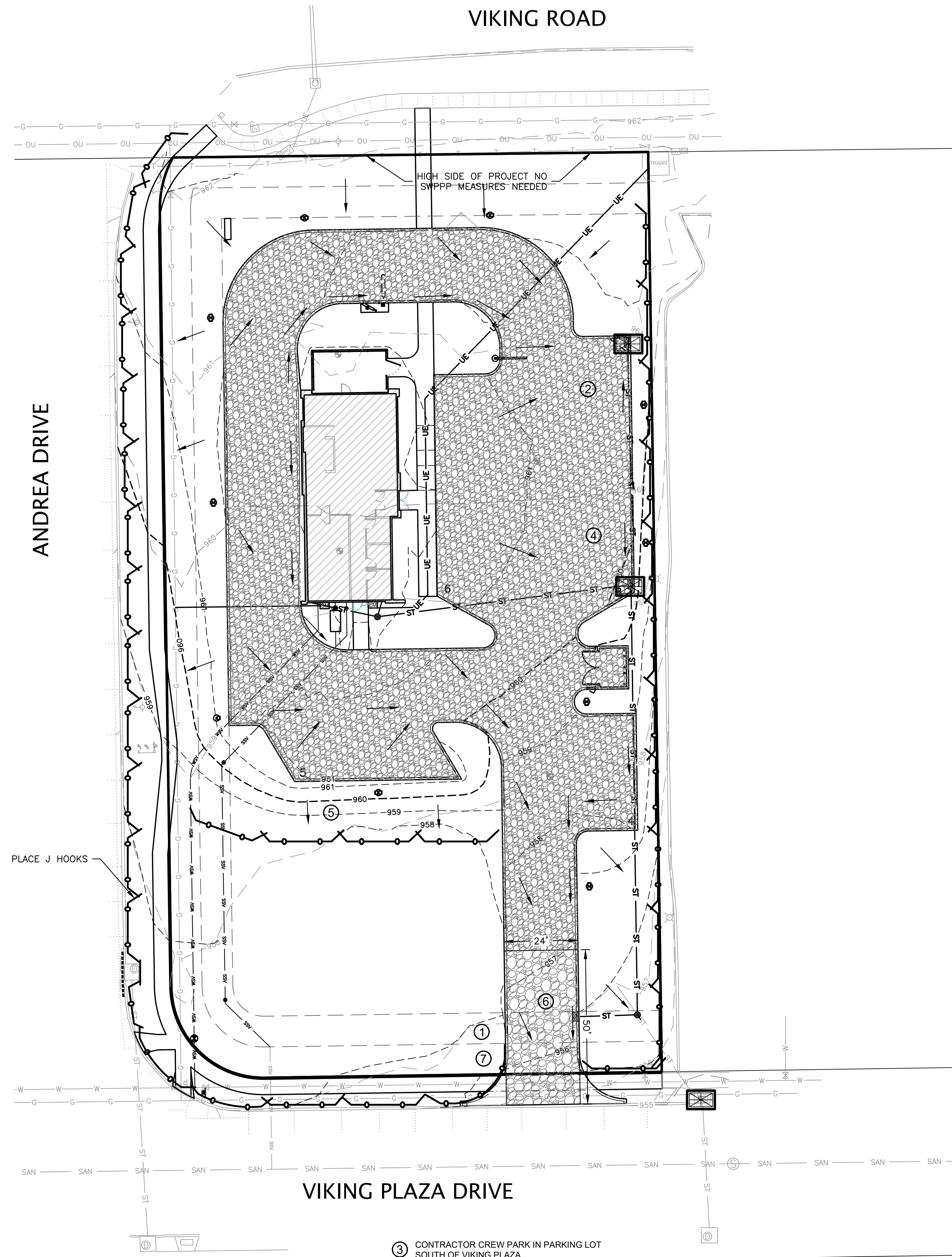

③ CONTRACTOR CREW PARK IN PARKING LOT SOUTH OF VIKING PLAZA

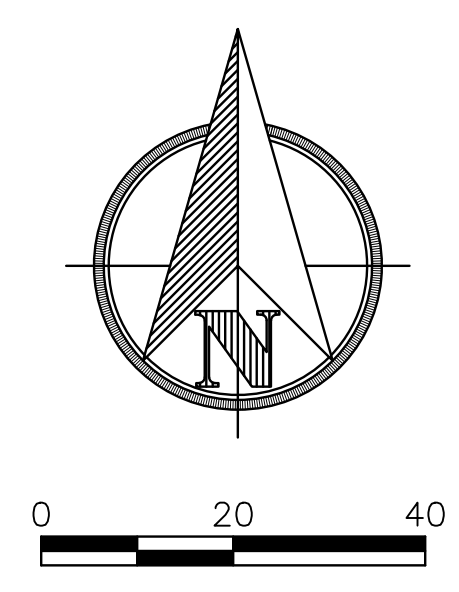

- KEY**
- ① PORTABLE SANITARY FACILITY
 - ② CONSTRUCTION DUMPSTER
 - ③ CONSTRUCTION PARKING
 - ④ CONSTRUCTION TRAILER
 - ⑤ MATERIAL STORAGE
 - ⑥ STABILIZED CONSTRUCTION ENTRANCE COMPLY WITH SUDAS 9040.12
 - ⑦ CONCRETE WASHOUT

- LEGEND**
- PCC
 - TOPSOIL, SEEDING, AND MULCHING (MAY INCLUDE LANDSCAPING, REFER TO LANDSCAPING PLAN)
 - GRANULAR SURFACING PERMANENT OR TEMPORARY
 - EROSION MULCHING
 - TEMPORARY ROLLED EROSION CONTROL PRODUCT
 - INLET PROTECTION - SILT BAG
 - INLET PROTECTION - SOCK
 - 9" - FILTER SOCK, MULCH FILL**
 - SILT FENCE
- ** MAY SUBSTITUTE WITH SILT FENCE OR MULCH BERM WHERE PERMITTED

- NOTES:**
1. NOT ALL KEY AND/OR LEGEND ITEMS MAY BE USED AND SHOWN ON THIS PLAN. THEY ARE AVAILABLE FOR USE IF NEEDED.
 2. PORTABLE SANITARY FACILITY SHALL BE STAKED DOWN TO WITHSTAND ANY ANTICIPATED WINDS
 3. CONCRETE SLURRY GENERATED BY WET SAWING SHALL BE VACUUMED OR UTILIZE OTHER ACCEPTABLE CONTAINMENT METHOD TO CAPTURE AND DISPOSE OF THE MATERIAL IN ACCORDANCE WITH APPLICABLE LAWS.

Robinson Engineering Company
Consulting Engineers



Huff Contracting, Inc.
Building since 1946

SWPPP - CONSTRUCTION

SCOOTERS VIKING PLAZA
PN 4290-20
B3 BREW, LLC
306 MAIN AVENUE
CLEAR LAKE, IOWA 50428

C3.2
3/28/2021
SUBMITTAL 3

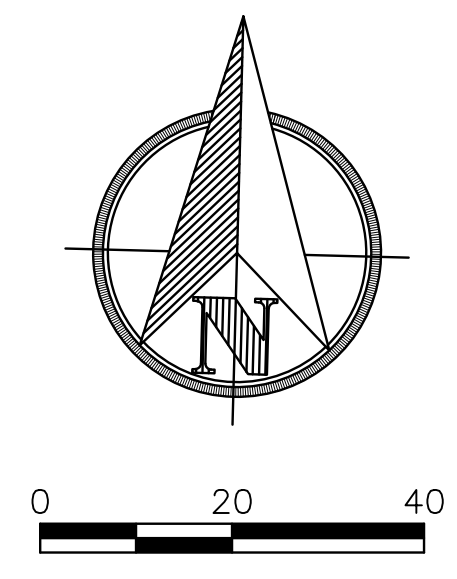
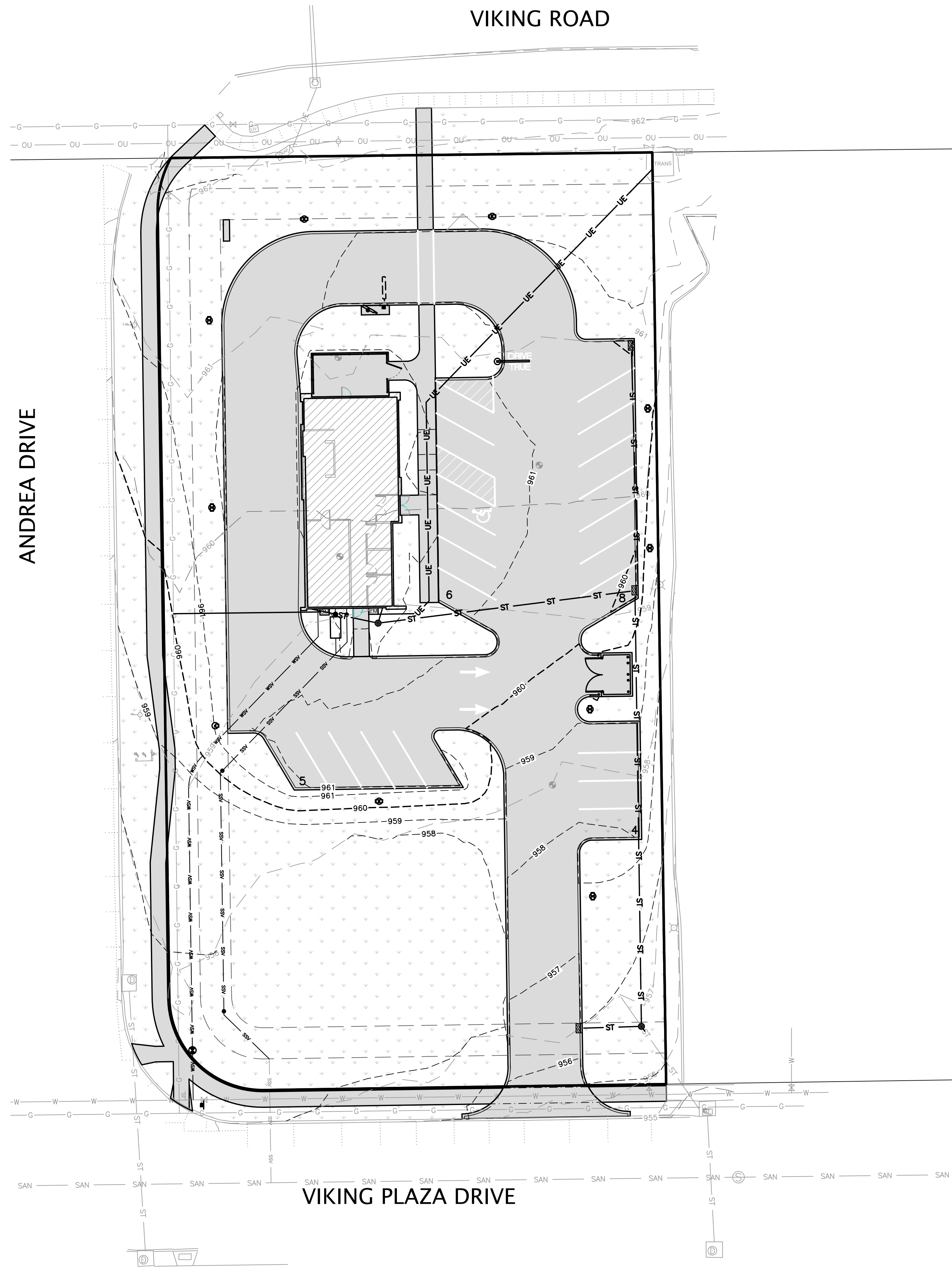

- KEY**
- ① PORTABLE SANITARY FACILITY
 - ② CONSTRUCTION DUMPSTER
 - ③ CONSTRUCTION PARKING
 - ④ CONSTRUCTION TRAILER
 - ⑤ MATERIAL STORAGE
 - ⑥ STABILIZED CONSTRUCTION ENTRANCE COMPLY WITH SUDAS 9040.12
 - ⑦ CONCRETE WASHOUT

- LEGEND**
- PCC
 - TOPSOIL, SEEDING, AND MULCHING (MAY INCLUDE LANDSCAPING, REFER TO LANDSCAPING PLAN)
 - GRANULAR SURFACING PERMANENT OR TEMPORARY
 - EROSION MULCHING
 - TEMPORARY ROLLED EROSION CONTROL PRODUCT
 - INLET PROTECTION - SILT BAG
 - INLET PROTECTION - SOCK
 - 9" - FILTER SOCK, MULCH FILL**
 - SILT FENCE
- ** MAY SUBSTITUTE WITH SILT FENCE OR MULCH BERM WHERE PERMITTED

- NOTES:**
1. NOT ALL KEY AND/OR LEGEND ITEMS MAY BE USED AND SHOWN ON THIS PLAN. THEY ARE AVAILABLE FOR USE IF NEEDED.
 2. PORTABLE SANITARY FACILITY SHALL BE STAKED DOWN TO WITHSTAND ANY ANTICIPATED WINDS
 3. CONCRETE SLURRY GENERATED BY WET SAWING SHALL BE VACUUMED OR UTILIZE OTHER ACCEPTABLE CONTAINMENT METHOD TO CAPTURE AND DISPOSE OF THE MATERIAL IN ACCORDANCE WITH APPLICABLE LAWS.

Robinson Engineering Company
Consulting Engineers

819 Second Street NE
Independence, Iowa 50644
319.334.7711



SWPPP - FINAL STABILIZATION

SCOOTER'S VIKING PLAZA
PN 4290-20
B3 BREW, LLC
306 MAIN AVENUE
CLEAR LAKE, IOWA 50428

C3.3
3/28/2021
SUBMITTAL 3



LANDSCAPE PLAN
SCOOTERS COFFEE - VIKING PLAZA

ZONED - HWY-1 - HIGHWAY COMMERCIAL DISTRICT
 LOT SIZE: 47,350 S.F. / 1.087 ACRES
 REQUIREMENTS PER ORDINANCE (PARAPHRASED):
 A. MIN. OPEN SPACE OF 10% EXCLUDING PERIMETER SETBACK
 B. MIN. 0.02 PTS/SF OF SITE AREA. (REDUCTIONS POSSIBLE SUBJECT TO APPROVAL)
 47,350 SF * 0.02 PTS/SF = 947 POINTS
 C. MIN. 0.75 PTS PER LF OF FRONTAGE
 600 LF FRONTAGE * 0.75PTS/LF = 450 PTS
 SUB REQUIREMENTS
 • OVERSTORY TREES PLACED ADJACENT TO PARKING AT A RATE OF 1 TREE PER 15 PARKING SPACES OR 1 TREE PER 2500 SF OF HARD SURFACE
 18,542 SF PAVEMENT / 2500 SF = 8 TREES
 • LANDSCAPING AROUND PERIMETER OF PARKING AREAS.
 OPEN SPACE PROVIDED
 TOTAL AREA WITHIN LANDSCAPE SETBACK: 35,999 SF
 TOTAL VEGETATED SURFACE: 14,429 S.F. (40.1%)

LANDSCAPE LEGEND

26	Dense Yew	Taxus x media 'Densiformis'	#5	3-4'	280
148	American Goldrush Rudbeckia	Rudbeckia 'American Goldrush'	#1	24-30"	N/A
1	Zafiro Dwarf Spruce	Picea pungens 'Zafiro'	#10	4-5'	10
1	Fat Albert Blue Spruce	Picea pungens 'Fat Albert'	5-6'	30-40'	80
35	Kodiak Bush Honeysuckle	Dienella rivularis 'G2X8544'	#3	4-5'	175
21	Caramel Coral Bells	Heuchera 'Caramel'	#1	18"	N/A
58	Heavy Metal Switch Grass	Panicum virgatum 'Heavy Metal'	#3	4-6'	N/A
6	Daylily	Hemerocallis 'Mighty Chestnut'	#1	24-30"	N/A
3	Eastern Arborvitae	Thuja occidentalis 'Filip's Magic Moment'	#2	3-4'	15
14	Dark Towers Penstemon	Penstemon 'Dark Towers'	#1	24"	N/A
22	Sundrop Spirea	Spiraea x bumalda 'Sundrop'	#2	18"	110
9	Green Mountain Boxwood	Buxus 'Green Mountain'	#5	30"	90
20	Happy Returns Daylily	Hemerocallis 'Happy Returns'	#1	24"	N/A
1	Palbin Lilac	Syringa meyeri 'Palbin' Tree Form	#7	4-6'	10
8	Standing Ovation Little Bluestem	Schizachyrium scoparium 'Standing Ovation'	#1	24"	N/A
6	Strawberry Sundae Hydrangea	Hydrangea paniculata 'Rensun'	#3	4'	30
15	Zinfin Doll Hydrangea	Hydrangea paniculata 'SMNHPRZEP'	#5	4'	150
10	Limelight Hydrangea	Hydrangea paniculata 'Limelight'	#5	5-6'	100
3	Firelight Hydrangea	Hydrangea paniculata 'SMNHPFL'	#5	5-6'	30
10	Sherwood Compact Mugo Pine	Pinus mugo 'Sherwood Compact'	#5	24"	100
6	Panther Ninebark	Physocarpus opulifolius 'N5'	#3	4'	30
2	Crimson Sunset Maple	Malus 'JFS-KW202'	2" Caliper	35-40'	120
5	Star Power Juniper	Juniperus x 'JN Select Blue'	4-5'	10-12'	150
15	Wesuwe Salvia	Salvia 'Wesuwe'	#1	18-24"	N/A
5	Standing Ovation Serviceberry	Amelanchier alnifolia 'Obelisk'	#5	12'	50
2	Swamp White Oak	Quercus bicolor	2"	40'	160
70	Millennium Onion	Allium 'Millennium'	#1	15"	N/A
Street Tree Plant Legend					
2	Existing Overstory Trees	Existing Trees		30-40'	200
4	Green Mountain Sugar Maple	Acer saccharum 'Green Mountain'	2" Caliper	40-50'	320

Robinson Engineering Company
Consulting Engineers



Huff Contracting, Inc.
Building since 1946

LANDSCAPE PLAN

SCOOTERS VIKING PLAZA
PN 4290-20
B3 BREW, LLC
306 MAIN AVENUE
CLEAR LAKE, IOWA 50428

C4.1
3/28/2021
SUBMITTAL 3

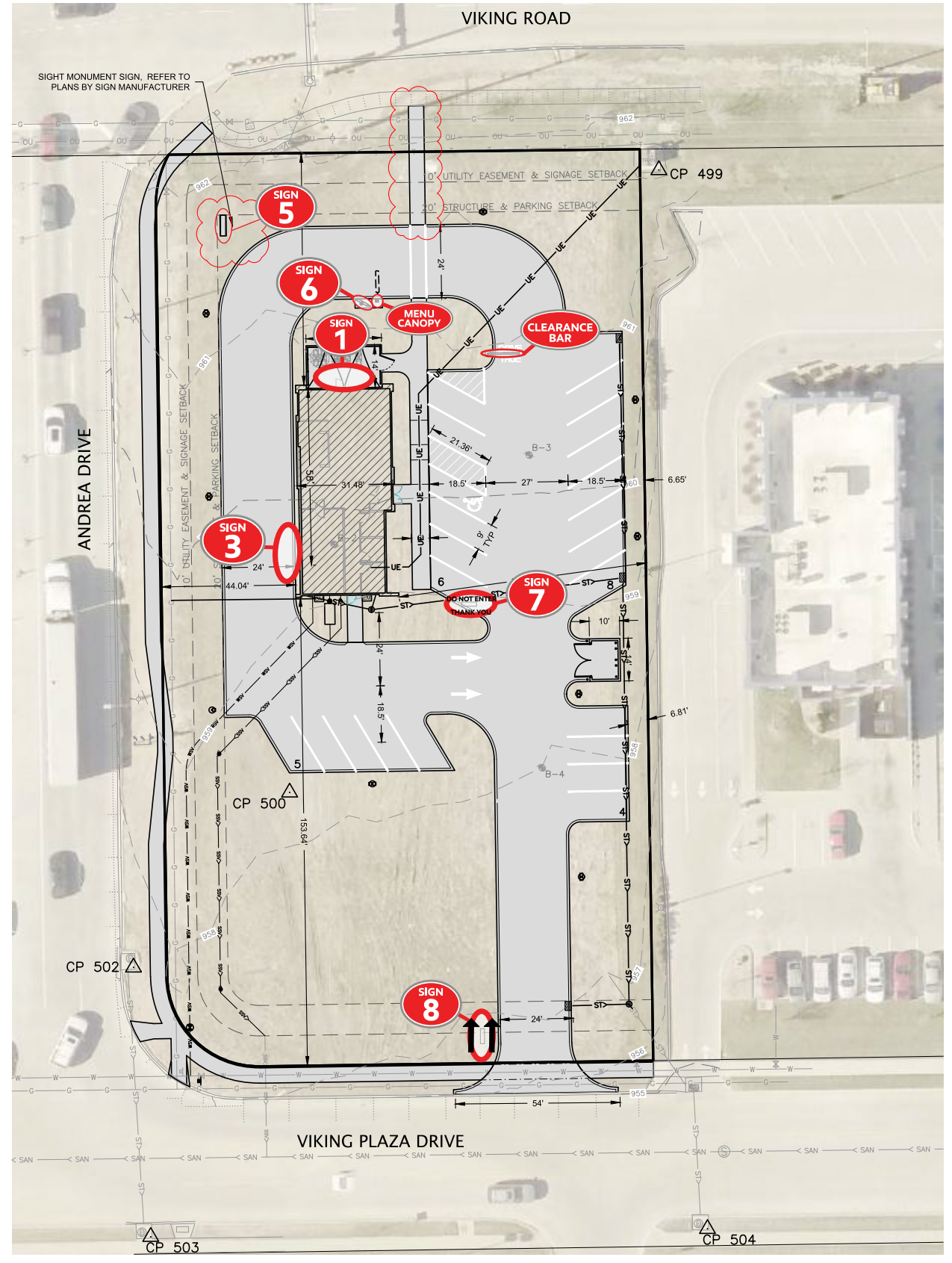

1120 N 18th Street • Omaha 68102
 402.341.6077 • 402.341.7654 fax

This design and all material appearing hereon constitute the original unpublished work of Omaha Neon Sign Co., Inc. and may not be duplicated, used or disclosed with written consent.

DRAWING # : Site Plan
PROJECT ID: 25086

SALES PERSON: Andye Nelson

DRAWN BY: wes stephens

SCOOTER'S
 COFFEE DRIVE-THRU

Viking Plaza
 Cedar Falls, IA

Date: 01.26.21
Revised: 03.29.21

NOTICE:
 ALL GRAPHIC REPRODUCTIONS ARE SUBJECTED BY APPROVAL OF AUTHORIZED CLIENT. AS OF APPROVAL BY THE UNDERSIGNED AND DATED PRIOR TO ANY FABRICATION OF PRODUCT. OMAHA NEON SIGN COMPANY, INC. HOLDS ALL AGREEMENTS FINAL AND TO CLIENT APPROVAL.

Signed _____ Date _____
 Sales Rep. _____ Date _____

This sign is intended to be installed in accordance with the requirements of Article 600 of the National Electric Code and/or other applicable local codes. This includes proper grounding and bonding of the sign.

UL LIST 100

ILLUMINATED CHANNEL LOGO

SCALE: 3/8" = 1'-0"

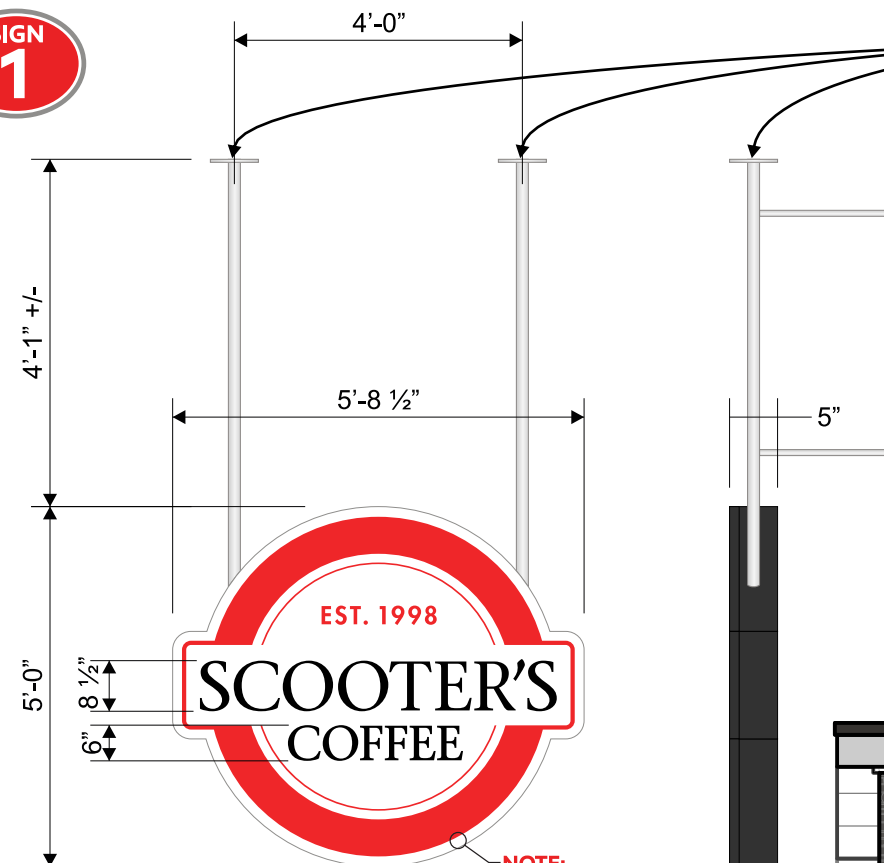

NOTE:
2 INCH x 2 INCH ALUMINUM Sq. TUBE SUPPORTS WITH 8 INCH x 8 INCH x 1/2" MOUNTING PLATE(S). SUPPORTS ARE TO BE PAINTED AKZO-NOBEL BRUSHED ALUMINUM.

NOTE:
1 INCH x 1 INCH ALUMINUM Sq. TUBE SUPPORTS WITH 4 INCH x 4 INCH x 1/4" ADJUSTING PLATE(S). SUPPORTS ARE TO BE PAINTED AKZO-NOBEL BRUSHED ALUMINUM.

NOTE:
ALUM. RETAINERS. FACE OF RETAINERS ARE TO BE PAINTED WHITE AND RETURNS ARE TO BE PAINTED BLACK.

28.6 Sq. Ft.

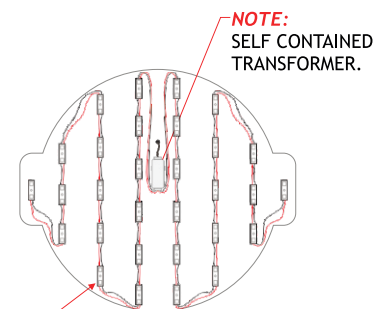

NOTE:
LED MODULES ARE RIVETED TO ALUMINUM BACK AND SEALED WITH SILICONE. NUMBER OF LED MODULES WILL VARY DEPENDING ON LOGO SIZE.

C1 NORTH ELEVATION
Scale: 1/4" = 1'-0"



19'-0" T.O. PARAPET

0'-0" T.O. FINISHED FLOOR

SCOOTER'S COFFEE DRIVE-THRU

Item 7.



SPECIFICATIONS

ILLUMINATED CHANNEL LOGO

FABRICATED FROM .050 BLACK PRE-FINISHED ALUMINUM RETURNS ATTACHED TO .063 ALUMINUM BACKS. FACE IS TO BE 3/16" WHITE PLEXIGLAS WITH 3M VINYL GRAPHICS APPLIED TO THE FIRST SURFACE (AS NOTED). INTERNAL ILLUMINATION WITH WHITE LED'S. LOGO IS TO BE MOUNTED TO FASCIA IN CUSTOMER SPECIFIED LOCATION USING PROPER HARDWARE AND FASTENERS (NON-CORROSIVE).

3M Series 230

TRANSLUCENT FILM

-  LT. TOMATO RED 230-43
-  BLACK 230-22



1120 N 18th Street • Omaha 68102
402.341.6077 • 402.341.7654 fax

This design and all material appearing hereon constitute the original unpublished work of Omaha Neon Sign Co., Inc. and may not be duplicated, used or disclosed with written consent.

DRAWING # : 126483
PROJECT ID: 25086

SALES PERSON: Andye Nelson

DRAWN BY: wes stephens



Viking Plaza
Cedar Falls, IA

Date: 01.26.21

Revised: 000000

NOTICE:

ALL GRAPHIC REPRODUCTIONS ARE SUBJECTED BY APPROVAL OF AUTHORIZED CLIENT. AS OF APPROVAL BY THE UNDERSIGNED AND DATED PRIOR TO ANY FABRICATION OF PRODUCT. OMAHA NEON SIGN COMPANY, INC. HOLDS ALL AGREEMENTS FINAL AND TO CLIENT APPROVAL.

Signed _____ Date _____
Sales Rep. _____ Date _____

This sign is intended to be installed in accordance with the requirements of Article 600 of the National Electric Code and/or other applicable local codes. This includes proper grounding and bonding of the sign.



SCOOTER'S COFFEE DRIVE-THRU

Awning Display

FRAME: 1"x 1" ALUM. Sq. TUBE FRAME (Painted Black)
SKIN: LOGO RED SUNBRELLA MATERIAL #6066-0000
GRAPHICS: (As Noted)

INSTALLATION:
 PANEL IS TO BE MOUNTED TO FASCIA USING PROPER
 HARDWARE AND FASTENERS (NON-CORROSIVE).
 14GA. Z-CLIPS - #12 SELF TAPPING TEKS - 3/16" 0 x 1 1/2"
 TAP CONS TO EXISTING FASCIA.

NON-ILLUMINATED AWNING DISPLAY
 SCALE: 1/2" = 1'-0" Item 7.

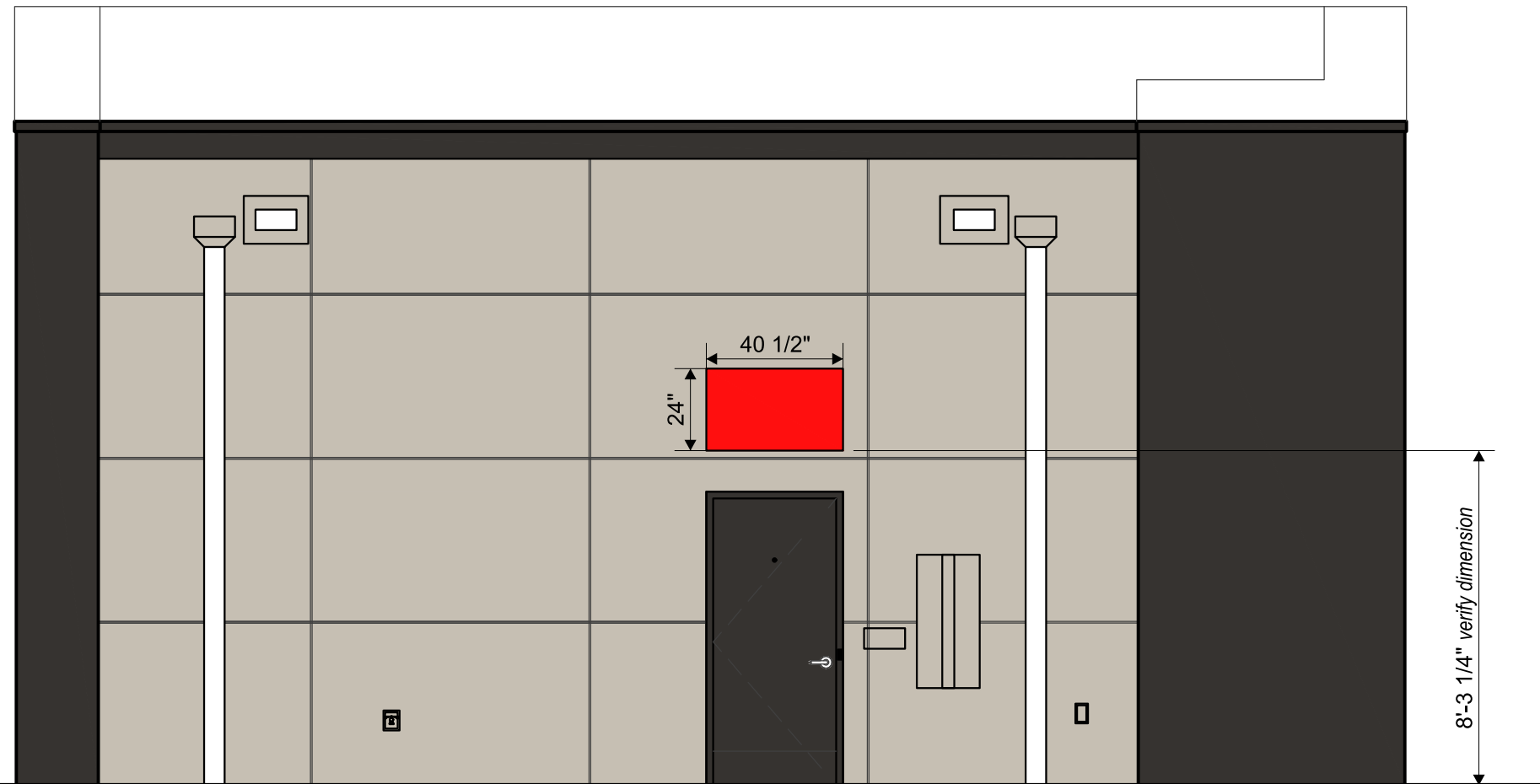
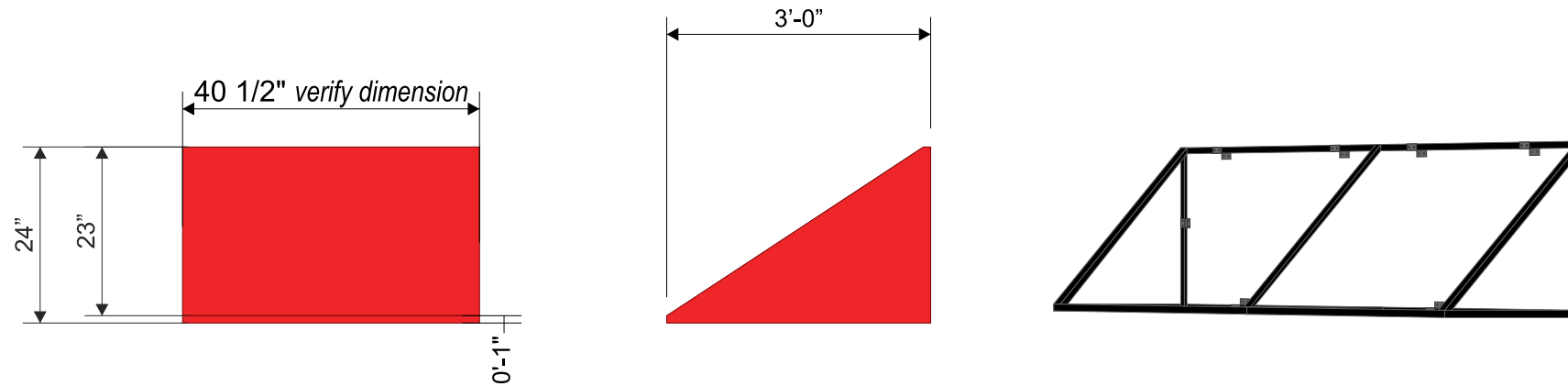

C3 SOUTH ELEVATION
 Scale: 1/4" = 1'-0"

0'-0"
 T.O. FINISHED FLOOR



1120 N 18th Street • Omaha 68102
 402.341.6077 • 402.341.7654 fax

This design and all material appearing hereon constitute the original unpublished work of Omaha Neon Sign Co., Inc. and may not be duplicated, used or disclosed with written consent.

DRAWING # : 126485
PROJECT ID: 25086

SALES PERSON: Andye Nelson

DRAWN BY: wes stephens



**Viking Plaza
 Cedar Falls, IA**

Date: 01.26.21

Revised: 03.02.21

NOTICE:

ALL GRAPHIC REPRODUCTIONS ARE SUBJECTED BY APPROVAL OF AUTHORIZED CLIENT. AS OF APPROVAL BY THE UNDERSIGNED AND DATED PRIOR TO ANY FABRICATION OF PRODUCT. OMAHA NEON SIGN COMPANY, INC. HOLDS ALL AGREEMENTS FINAL AND TO CLIENT APPROVAL.

Signed _____ Date _____
 Sales Rep. _____ Date _____

This sign is intended to be installed in accordance with the requirements of Article 600 of the National Electric Code and/or other applicable local codes. This includes proper grounding and bonding of the sign.



**SIGN
3**

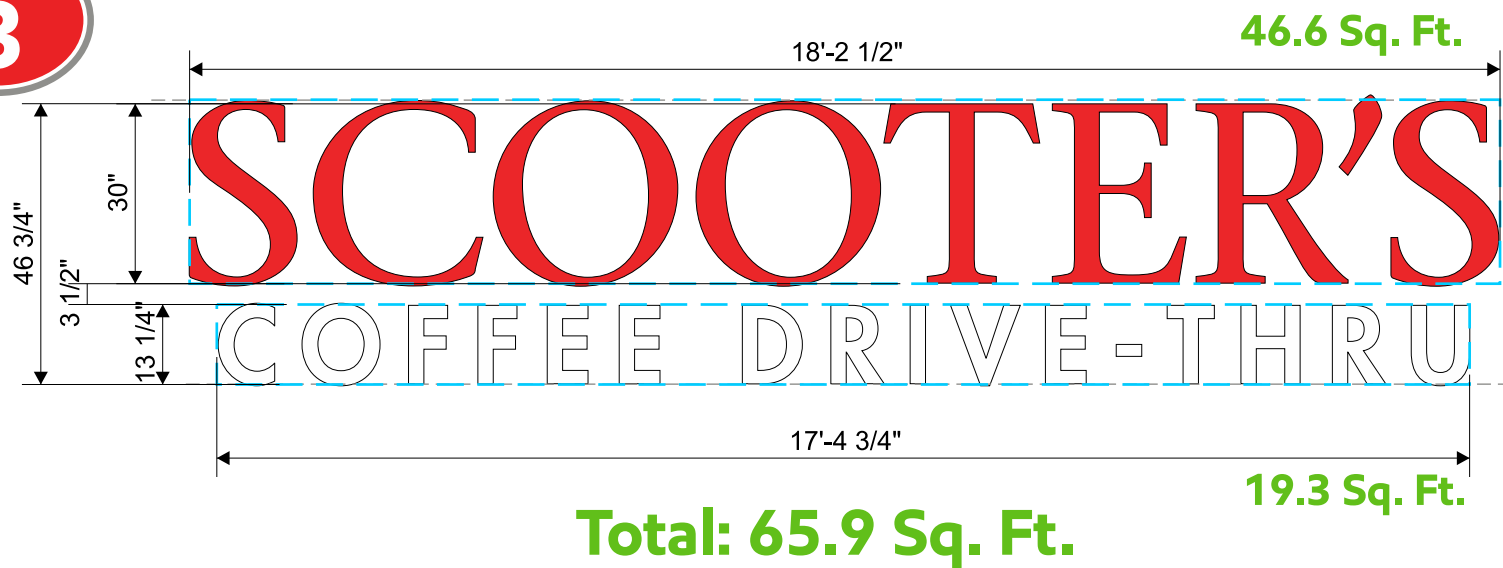

NOTE:
ALUMINUM REVERSE RACEWAY
LOCATED ON ROOF BEHIND
PARAPET WALL.

NOTE:
POWER TO EXIT AT TOP AREA OF
"SCOOTER'S"

NOTE:
POWER TO EXIT AT LOWEST POINT
OF "COFFEE DRIVE-THRU"

NOTE:
POWER TO EXIT LOWER
LETTERS AND ENTER STORE.

FLUSH MOUNTED CHANNEL L
SCALE: 3/8" Item 7.

SCOOTER'S COFFEE DRIVE-THRU	
Channel Letter Specifications	
SCOOTER'S	
RETURNS:	3 Inch Deep .040 Blk. Pre-Finished Aluminum
BACKS:	.063 White Pre-Finished Aluminum
FACES:	.1875 White Acrylic
VINYL:	230-43 Tomato Red - Translucent
TRIM-CAP:	1 Inch Black
ILLUMINATION:	Red Hanley LED's
COFFEE DRIVE-THRU	
RETURNS:	3 Inch Deep .040 Blk. Pre-Finished Aluminum
BACKS:	.063 White Pre-Finished Aluminum
FACES:	.1875 White Acrylic
TRIM-CAP:	1 Inch Black
ILLUMINATION:	White Hanley LED's

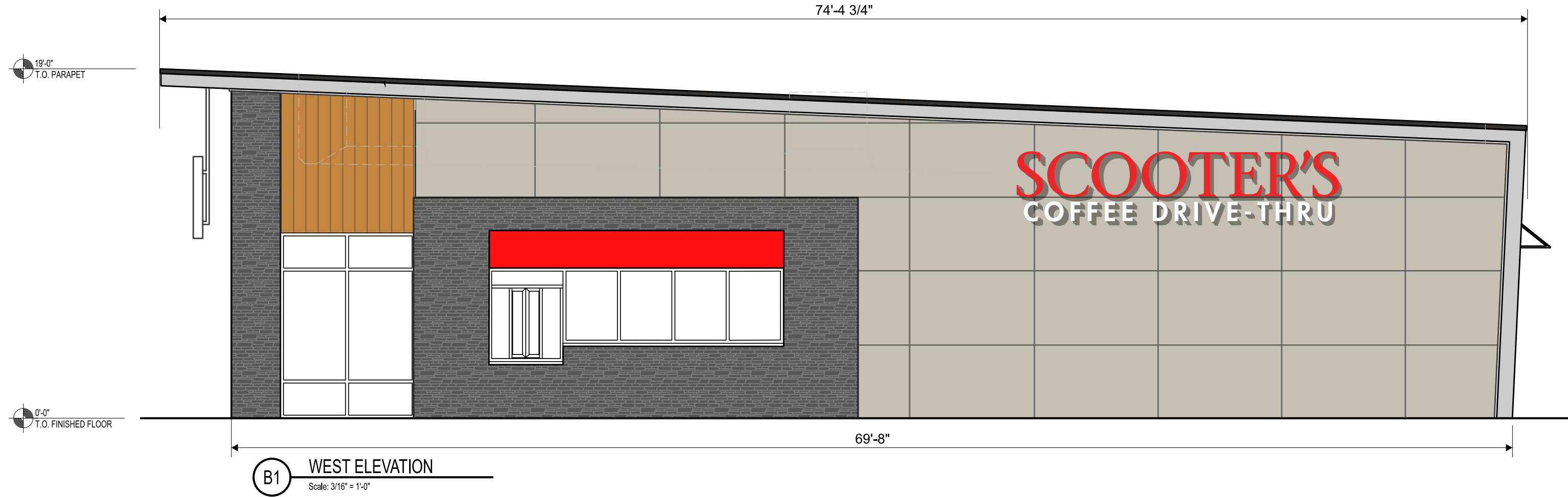

**Omaha Neon
Sign Company**

1120 N 18th Street • Omaha 68102
402.341.6077 • 402.341.7654 fax

This design and all material appearing hereon constitute the original unpublished work of Omaha Neon Sign Co., Inc. and may not be duplicated, used or disclosed with written consent.

DRAWING # : 126486
PROJECT ID: 25086

SALES PERSON: Andye Nelson

DRAWN BY: wes stephens

**Viking Plaza
Cedar Falls, IA**

Date: 01.26.21
Revised: 03.29.21

NOTICE:
ALL GRAPHIC REPRODUCTIONS ARE SUBJECTED BY APPROVAL OF AUTHORIZED CLIENT. AS OF APPROVAL BY THE UNDERSIGNED AND DATED PRIOR TO ANY FABRICATION OF PRODUCT. OMAHA NEON SIGN COMPANY, INC. HOLDS ALL AGREEMENTS FINAL AND TO CLIENT APPROVAL.

Signed _____ Date _____
Sales Rep. _____ Date _____

This sign is intended to be installed in accordance with the requirements of Article 600 of the National Electric Code and/or other applicable local codes. This includes proper grounding and bonding of the sign.

UL LIST 103

SCOOTER'S COFFEE DRIVE-THRU

Awning Display

FRAME: 1"x 1" ALUM. Sq. TUBE FRAME (Painted Black)
SKIN: LOGO RED SUNBRELLA MATERIAL #6066-0000
GRAPHICS: (As Noted)

INSTALLATION:
 PANEL IS TO BE MOUNTED TO FASCIA USING PROPER
 HARDWARE AND FASTENERS (NON-CORROSIVE).
 14GA. Z-CLIPS - #12 SELF TAPPING TEKS - 3/16" 0 x 1 1/2"
 TAP CONS TO EXISTING FASCIA.

NON-ILLUMINATED AWNING D
 SCALE: 1/2" Item 7.

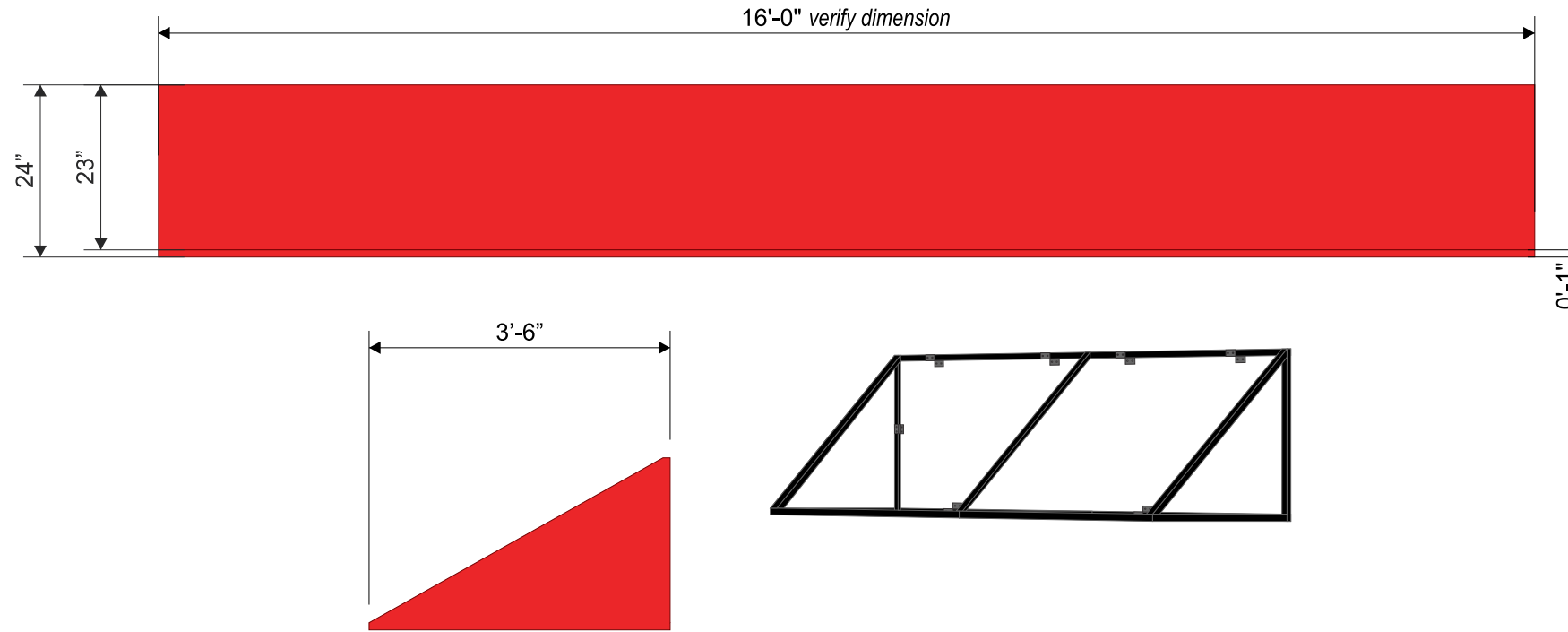

19'-0"
T.O. PARAPET

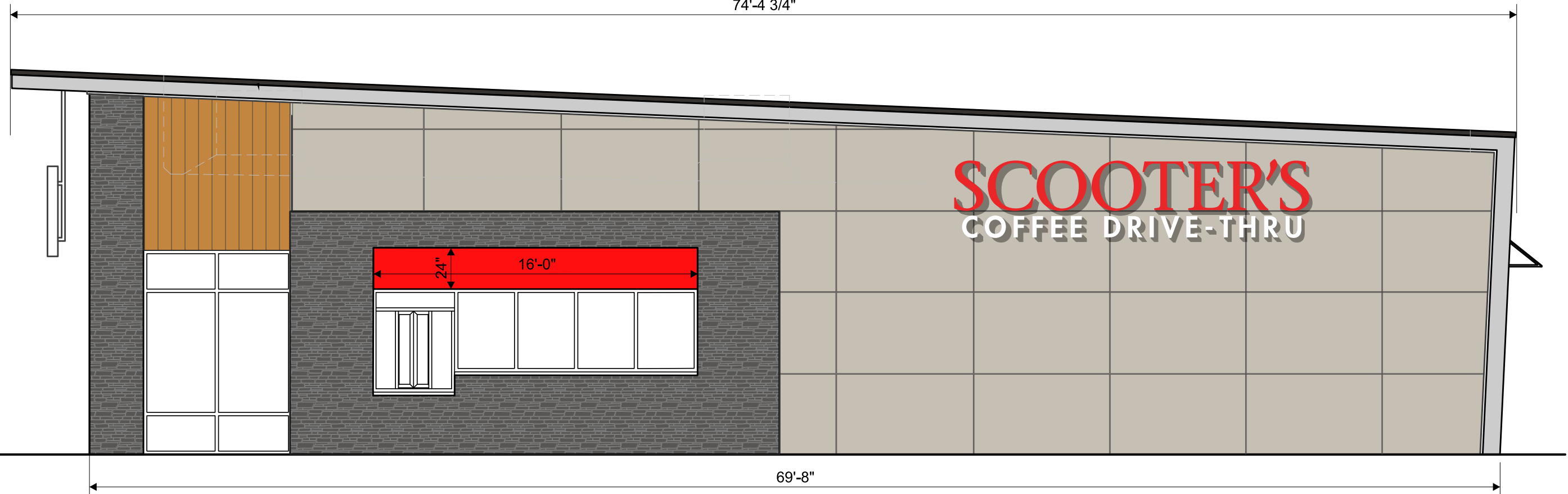

0'-0"
T.O. FINISHED FLOOR

B1 WEST ELEVATION
 Scale: 3/16" = 1'-0"



1120 N 18th Street • Omaha 68102
 402.341.6077 • 402.341.7654 fax

This design and all material appearing hereon constitute the original unpublished work of Omaha Neon Sign Co., Inc. and may not be duplicated, used or disclosed with written consent.

DRAWING # : 126487
PROJECT ID: 25086

SALES PERSON: Andye Nelson

DRAWN BY: wes stephens

**SCOOTER'S
COFFEE DRIVE-THRU**

**Viking Plaza
Cedar Falls, IA**

Date: 01.26.21

Revised: 03.29.21

NOTICE:

ALL GRAPHIC REPRODUCTIONS ARE SUBJECTED BY APPROVAL OF AUTHORIZED CLIENT. AS OF APPROVAL BY THE UNDERSIGNED AND DATED PRIOR TO ANY FABRICATION OF PRODUCT. OMAHA NEON SIGN COMPANY, INC. HOLDS ALL AGREEMENTS FINAL AND TO CLIENT APPROVAL.

Signed _____ Date _____
 Sales Rep. _____ Date _____

This sign is intended to be installed in accordance with the requirements of Article 600 of the National Electric Code and/or other applicable local codes. This includes proper grounding and bonding of the sign.



SCOOTER'S COFFEE DRIVE-THRU

Awning Display

FRAME: 1"x 1" ALUM. Sq. TUBE FRAME (Painted Black)
SKIN: LOGO RED SUNBRELLA MATERIAL #6066-0000
GRAPHICS: (As Noted)

INSTALLATION:
 PANEL IS TO BE MOUNTED TO FASCIA USING PROPER
 HARDWARE AND FASTENERS (NON-CORROSIVE).
 14GA. Z-CLIPS - #12 SELF TAPPING TEKS - 3/16" 0 x 1 1/2"
 TAP CONS TO EXISTING FASCIA.

NON-ILLUMINATED AWNING D
 SCALE: 1/2" Item 7.

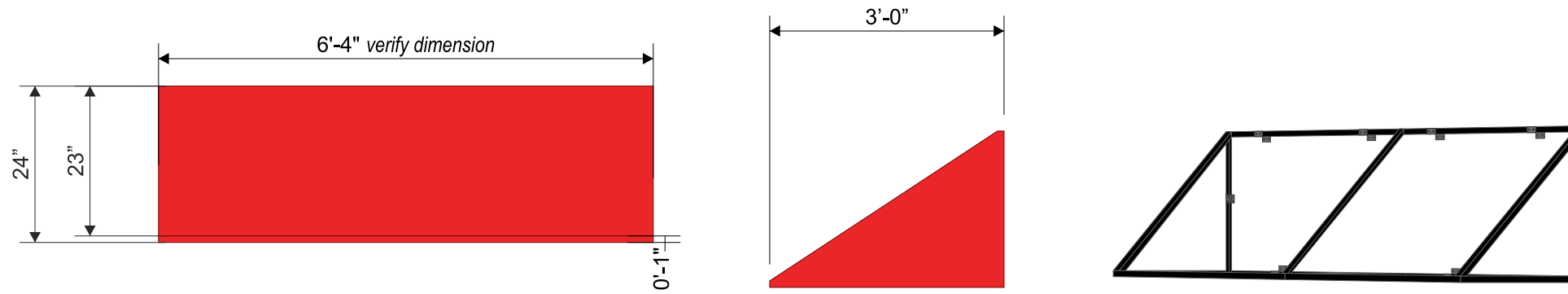

A1 EAST ELEVATION
 Scale: 3/16" = 1'-0"



1120 N 18th Street • Omaha 68102
 402.341.6077 • 402.341.7654 fax

This design and all material appearing hereon constitute the original unpublished work of Omaha Neon Sign Co., Inc. and may not be duplicated, used or disclosed with written consent.

DRAWING # : 126489
PROJECT ID: 25086

SALES PERSON: Andye Nelson

DRAWN BY: wes stephens



**Viking Plaza
 Cedar Falls, IA**

Date: 01.26.21

Revised: 03.29.21

NOTICE:

ALL GRAPHIC REPRODUCTIONS ARE SUBJECTED BY APPROVAL OF AUTHORIZED CLIENT. AS OF APPROVAL BY THE UNDERSIGNED AND DATED PRIOR TO ANY FABRICATION OF PRODUCT. OMAHA NEON SIGN COMPANY, INC. HOLDS ALL AGREEMENTS FINAL AND TO CLIENT APPROVAL.

Signed _____ Date _____
 Sales Rep. _____ Date _____

This sign is intended to be installed in accordance with the requirements of Article 600 of the National Electric Code and/or other applicable local codes. This includes proper grounding and bonding of the sign.



D/F MONUMENT SIGN DISPLAY:
SCALE: 3/8" = 1'-0"

SIGN
5

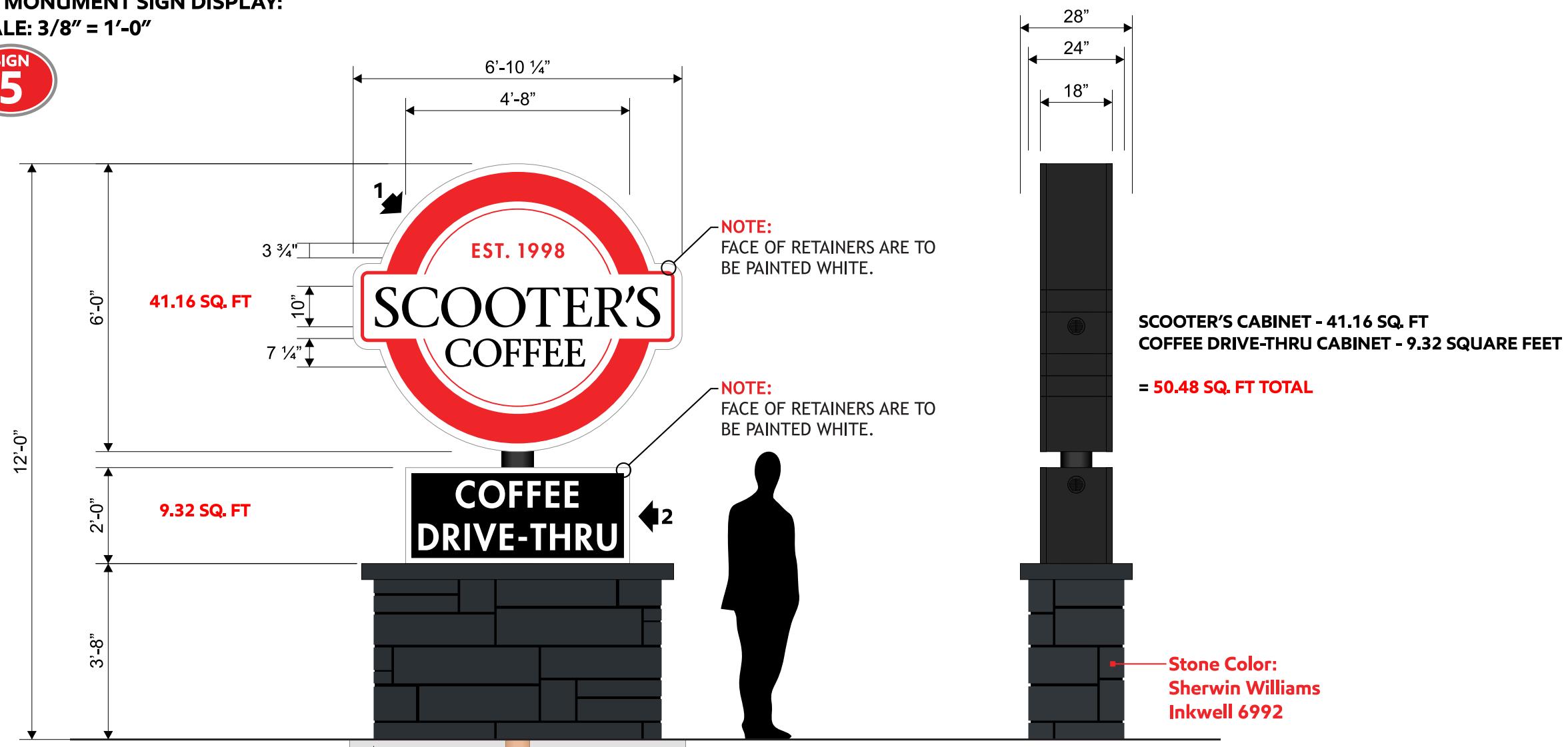

SPREAD FOOTING DETAIL
DEPTH: 5'-0"
FACE WIDTH: 7'-0"
END WIDTH: 3'-0"
TYPE: SPREAD
STEEL SIZE: 6 INCH STD.
TO BE VERIFIED

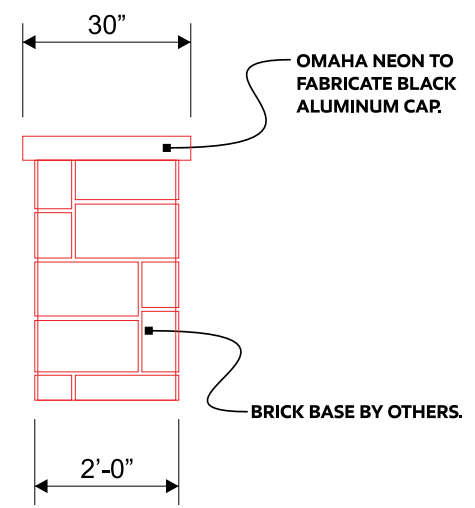
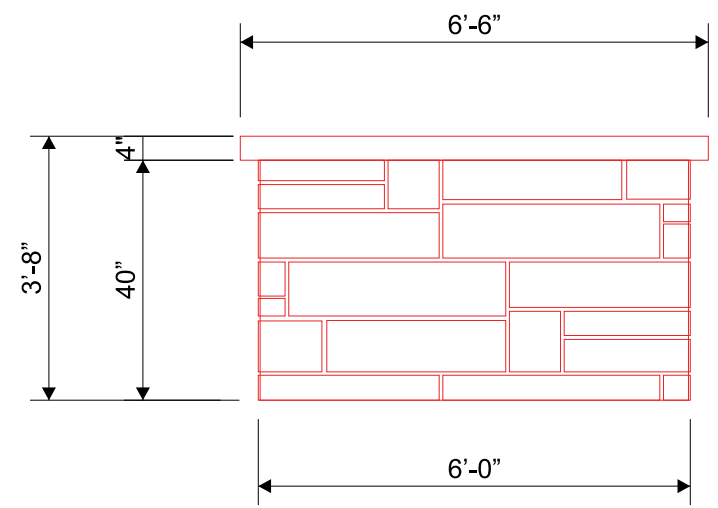

1 SCOOTER'S COFFEE DRIVE-THRU Item 7.
Monument Sign Display (Primary)

FABRICATED FROM .050 ALUMINUM PAINTED WHITE OVER AN INTERNAL ANGLE FRAME WITH WHITE PRE-FINISHED ALUMINUM SKIN. RETAINERS ARE TO BE ALUMINUM PAINTED WHITE. FACES ARE TO BE WHITE LEXAN WITH 3M VINYL GRAPHICS APPLIED TO THE FIRST SURFACE (AS NOTED). INTERNAL ILLUMINATION WITH ONE (1) ROW OF WT HANLEY PHEONIX LED LIGHTING. CABINET IS TO BE MOUNTED TO SINGLE POLE STRUCTURE (AS NOTED).

2 SCOOTER'S COFFEE DRIVE-THRU
Monument Sign Display (Secondary)

FABRICATED FROM EC-FRAME (EXTRUDED ALUMINUM AND WILL HAVE ALUMINUM SKIN PAINTED. CABINET AND RETAINERS ARE TO BE PAINTED WHITE. FACE(S) IS TO BE 3/16" WHITE PLEXIGLAS #2793 WITH 3M VINYL GRAPHICS APPLIED TO THE FIRST SURFACE. INTERNAL ILLUMINATION WITH WHITE HANLEY PHOENIX S/S LED'S. CABINET IS TO BE MOUNTED TO POLE STRUCTURE USING PROPER HARDWARE AND FASTENERS (NON-CORROSIVE).

3M Series 230
TRANSLUCENT FILM

LT. TOMATO RED
230-43

BLACK
230-22



1120 N 18th Street • Omaha 68102
402.341.6077 • 402.341.7654 fax

This design and all material appearing hereon constitute the original unpublished work of Omaha Neon Sign Co., Inc. and may not be duplicated, used or disclosed with written consent.

DRAWING # : 126490
PROJECT ID: 25086

SALES PERSON: Andye Nelson

DRAWN BY: wes stephens



Viking Plaza
Cedar Falls, IA

Date: 01.26.21

Revised: 000000

NOTICE:
ALL GRAPHIC REPRODUCTIONS ARE SUBJECTED BY APPROVAL OF AUTHORIZED CLIENT. AS OF APPROVAL BY THE UNDERSIGNED AND DATED PRIOR TO ANY FABRICATION OF PRODUCT. OMAHA NEON SIGN COMPANY, INC. HOLDS ALL AGREEMENTS FINAL AND TO CLIENT APPROVAL.

Signed _____ Date _____
Sales Rep. _____ Date _____

This sign is intended to be installed in accordance with the requirements of Article 600 of the National Electric Code and/or other applicable local codes. This includes proper grounding and bonding of the sign.

UL LIST 106

SIGN 6

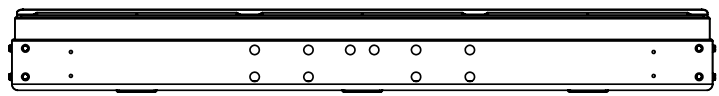
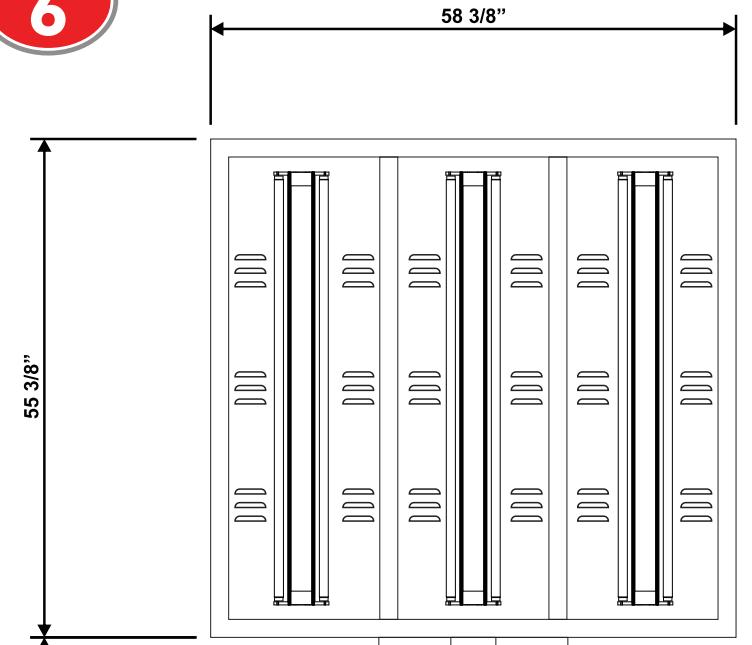

Scooter's Coffee
Project U19
 Ref#GK-18-536r3 • Aug. 21, 2018

- ILLUMINATED DRIVE-THRU SYSTEM:**
- ☐ LED LIGHTING
 - ☐ MOUNTED TO EXISTING PIPE AND FOOTING AS SHOWN
 - ☐ GRAPHICS ARE CHANGEABLE

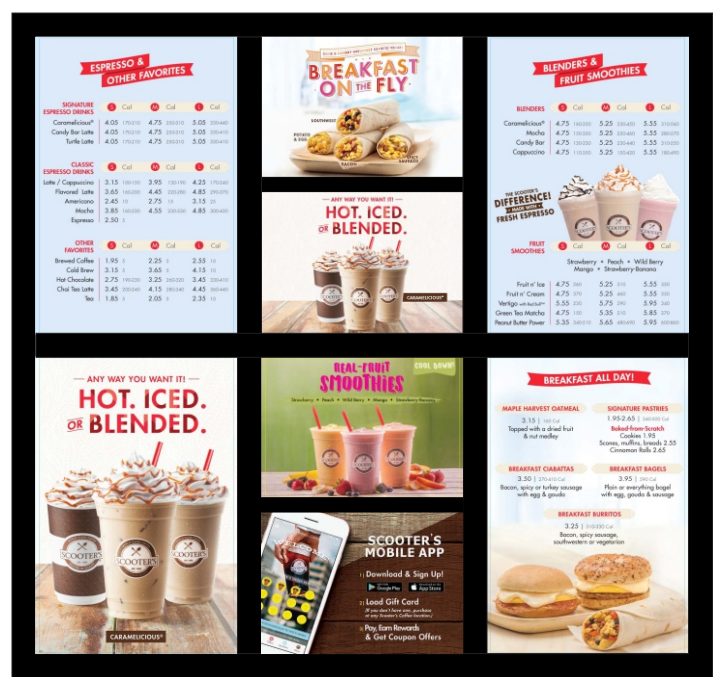

19" **ELECTRICAL DISCONNECT**

LOW VOLTAGE ACCESS

TS 5"x 5"x 3/16" ASTM A-500 Gr. B

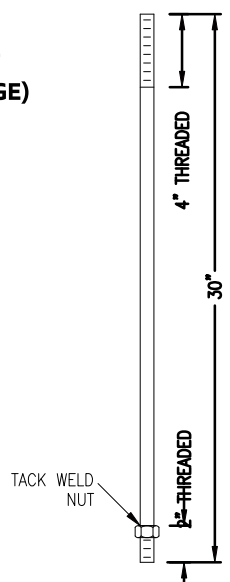
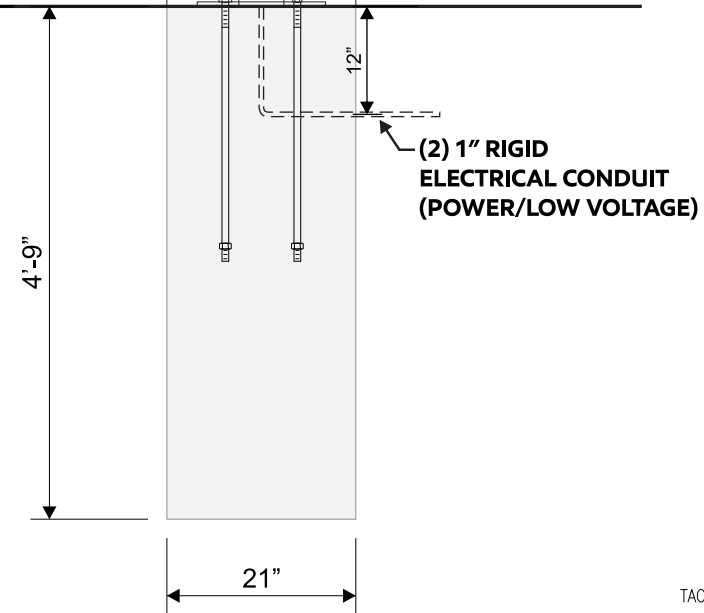

ANCHOR BOLT DETAIL
 ø3/4" AASHTO M314-90 Gr. 2 STEEL
 CAN USE EITHER STYLE ANCHOR BOLT

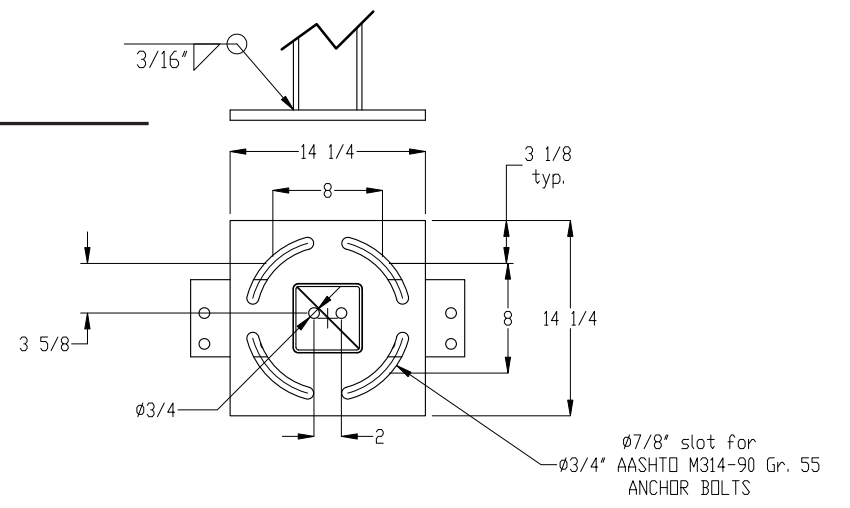
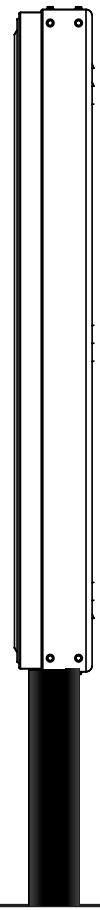
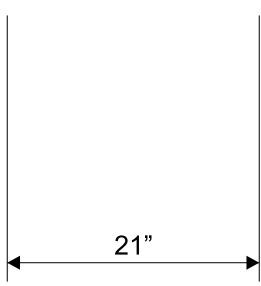

BASE PLATE DETAIL
 3/4" ASTM A-36 STEEL



1120 N 18th Street • Omaha 68102
 402.341.6077 • 402.341.7654 fax

This design and all material appearing hereon constitute the original unpublished work of Omaha Neon Sign Co., Inc. and may not be duplicated, used or disclosed with written consent.

DRAWING # : 126491
PROJECT ID: 25086

SALES PERSON: Andye Nelson

DRAWN BY: wes stephens



Viking Plaza Cedar Falls, IA

Date: 01.26.21

Revised: 000000

NOTICE:
 ALL GRAPHIC REPRODUCTIONS ARE SUBJECTED BY APPROVAL OF AUTHORIZED CLIENT. AS OF APPROVAL BY THE UNDERSIGNED AND DATED PRIOR TO ANY FABRICATION OF PRODUCT. OMAHA NEON SIGN COMPANY, INC. HOLDS ALL AGREEMENTS FINAL AND TO CLIENT APPROVAL.

Signed _____ Date _____
 Sales Rep. _____ Date _____

This sign is intended to be installed in accordance with the requirements of Article 600 of the National Electric Code and/or other applicable local codes. This includes proper grounding and bonding of the sign.

UL LIST 107

SCOOTER'S COFFEE DRIVE-THRU	
Directional Sign Display	
INTERIOR FRAME:	1 Inch Angle Iron
CABINET COLOR:	.063 Aluminum Painted Black.
TRIM-CAP:	1 Inch Black.
FACE MATERIAL:	3/16" White Plexiglas
GRAPHICS:	Applied Vinyl Graphics (as noted).
ILLUMINATION:	White Hanley LED's
CABINET IS TO BE MOUNTED IN CUSTOMER SPECIFIED LOCATION USING PROPER HARDWARE AND FASTENERS (NON-CORROSIVE).	

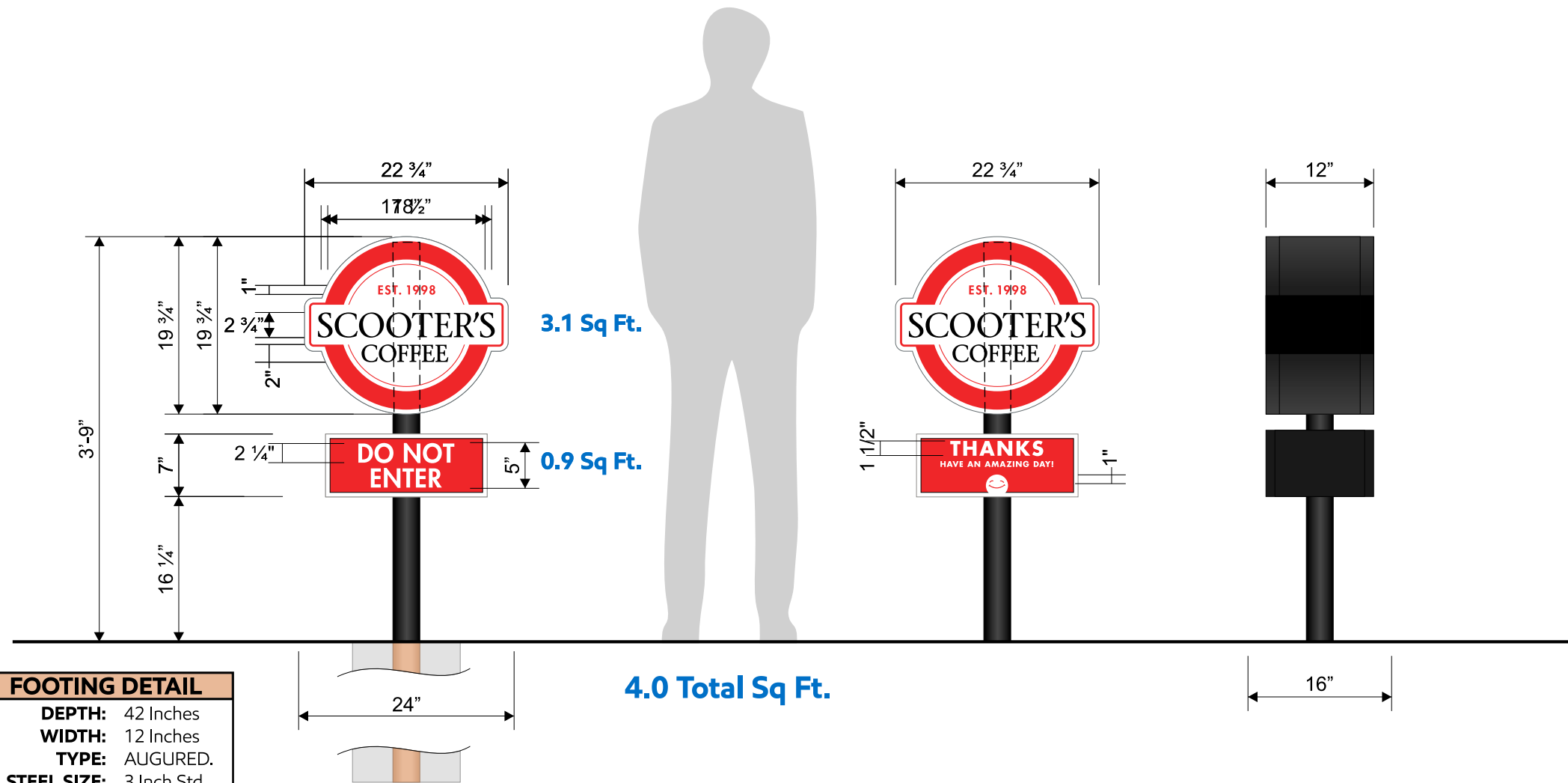

3M Series 230
TRANSLUCENT FILM

	LT. TOMATO RED 230-43
	BLACK 230-22

NOTICE:

ALL GRAPHIC REPRODUCTIONS ARE SUBJECTED BY APPROVAL OF AUTHORIZED CLIENT. AS OF APPROVAL BY THE UNDERSIGNED AND DATED PRIOR TO ANY FABRICATION OF PRODUCT. OMAHA NEON SIGN COMPANY, INC. HOLDS ALL AGREEMENTS FINAL AND TO CLIENT APPROVAL.

Signed _____ Date _____
Sales Rep. _____ Date _____

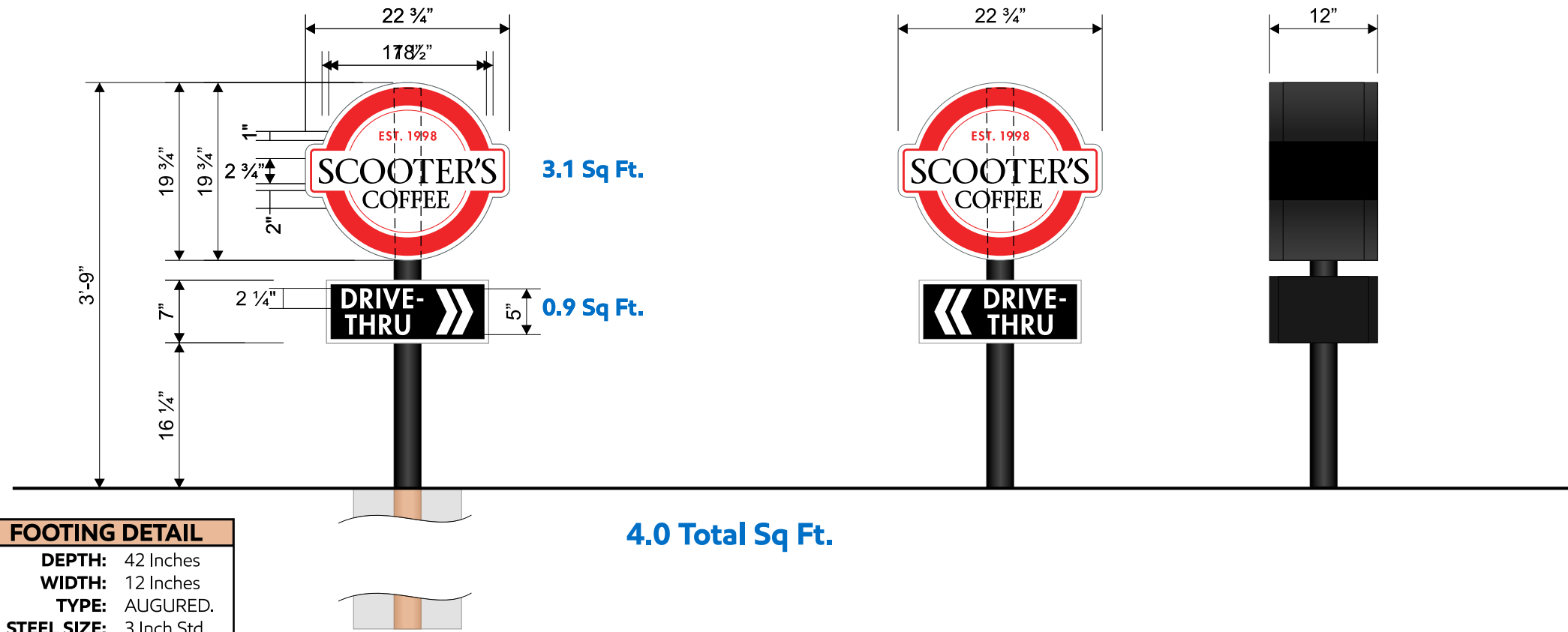

This sign is intended to be installed in accordance with the requirements of Article 600 of the National Electric Code and/or other applicable local codes. This includes proper grounding and bonding of the sign.



FOOTING DETAIL	
DEPTH:	42 Inches
WIDTH:	12 Inches
TYPE:	AUGURED.
STEEL SIZE:	3 Inch Std.

NOTE: TO BE VERIFIED.

SCOOTER'S COFFEE DRIVE-THRU Directional Sign Display	
INTERIOR FRAME:	1 Inch Angle Iron
CABINET COLOR:	.063 Aluminum Painted Black.
TRIM-CAP:	1 Inch Black.
FACE MATERIAL:	3/16" White Plexiglas
GRAPHICS:	Applied Vinyl Graphics (as noted).
ILLUMINATION:	White Hanley LED's
CABINET IS TO BE MOUNTED IN CUSTOMER SPECIFIED LOCATION USING PROPER HARDWARE AND FASTENERS (NON-CORROSIVE).	

3M Series 230 TRANSLUCENT FILM	
	LT. TOMATO RED 230-43
	BLACK 230-22

NOTICE:

ALL GRAPHIC REPRODUCTIONS ARE SUBJECTED BY APPROVAL OF AUTHORIZED CLIENT. AS OF APPROVAL BY THE UNDERSIGNED AND DATED PRIOR TO ANY FABRICATION OF PRODUCT. OMAHA NEON SIGN COMPANY, INC. HOLDS ALL AGREEMENTS FINAL AND TO CLIENT APPROVAL.

Signed _____ Date _____
Sales Rep. _____ Date _____

This sign is intended to be installed in accordance with the requirements of Article 600 of the National Electric Code and/or other applicable local codes. This includes proper grounding and bonding of the sign.

MENU CANOPY

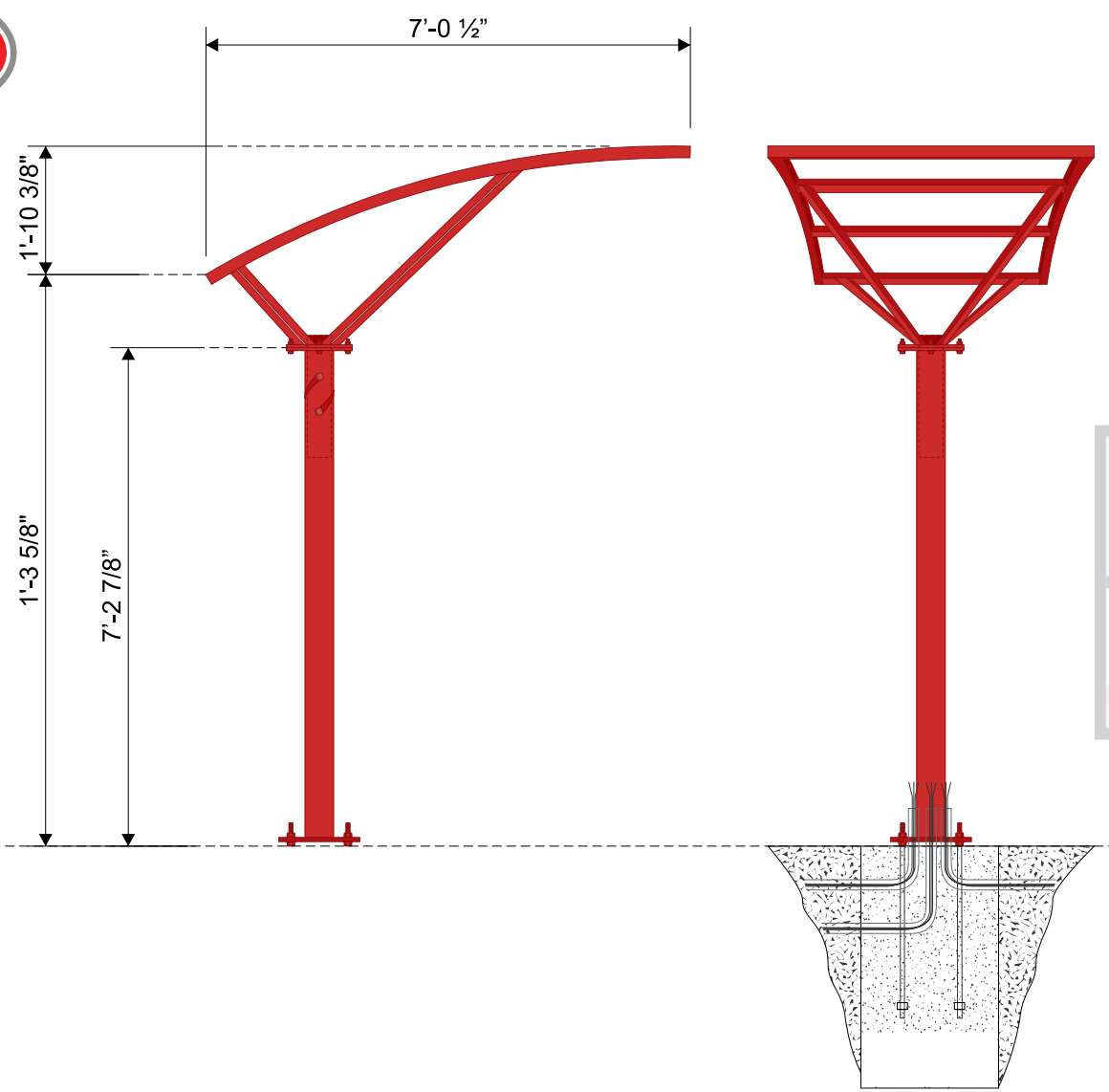

Item 7.

Mounting to Foundation

After the concrete has set, remove template and discard. **NOTE: Do not discard the four (4) or, (8) nuts that were just removed.**

The pedestal base plate is now ready to be mounted. Remove any concrete residue from the threads of the anchor bolts. Thread one (1) nut onto each bolt until it stops; then put a flat washer over each bolt. Feed the 120VAC power lines and ground lead into the inside back hole of the bottom of the pedestal base (see Diagram G, H and J). Set pedestal base onto anchor bolts place a flat and lock washer over each bolt, and thread on nut. The top surface of the pedestal base should be rough leveled at this time. Adjust the upper and lower hex nuts until the pedestal base is level and tighten. **NOTE: Final leveling can be done after the product is in place (if required).** Use the same procedure as above.

Locate the power leads. These will be hanging from the opening in the bottom of the menu board.

The product is factory wired and needs only to be energized on the job site. This should be done by a qualified electrician only. No disassembly is required.

Connect unit power leads and grounding conductor (green lead) to the power source. Power source must be 120VAC, 60 Hz. Energize the circuit to check the operation. Connect the speaker/microphone (if provided) to the internal communication system

WARNING: DO NOT CONNECT THE SPEAKER/MIC/DATA/CAT 5/LOOP WIRE TO 120VAC (POWER SOURCE).

AMPS REQUIRED 120V

CURVED TOP CANOPY LED LIGHTING - .2amps
FLAT TOP CANOPY LED LIGHTING - .3amps



DIAGRAM J

***CANOPY WITH SPEAKER/MIC AND LIGHTING (LOOP REQUIRED)**

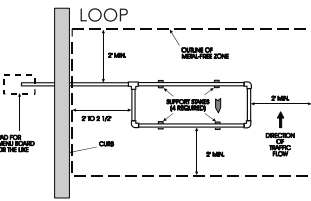
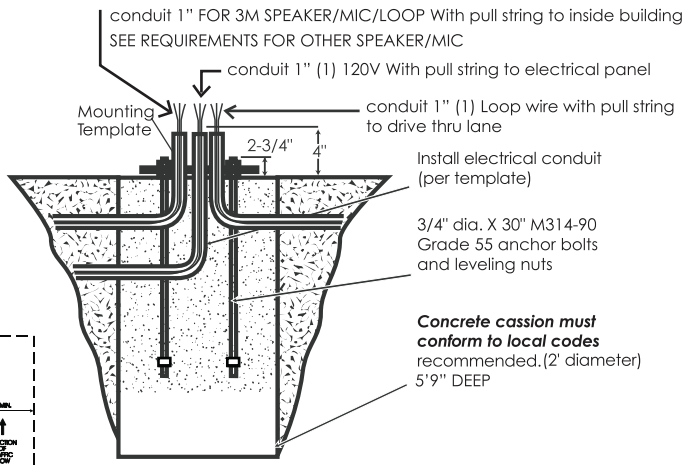

Mounting Template

DIAGRAM C

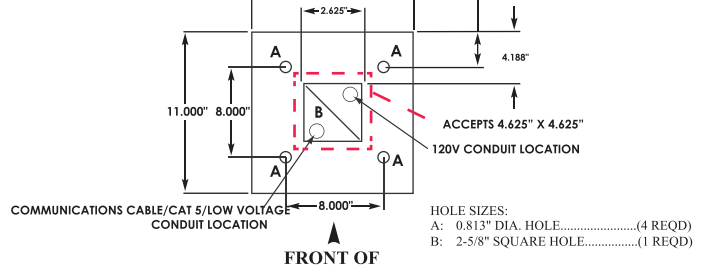

Foundation

The high voltage conduit must be installed in place by a qualified contractor. It runs from the power source to the menu board location. A conduit stub should protrude 4" above the concrete slab (see Diagram I, J, K and L) Use the template supplied for the correct relation between the mounting bolts and the conduit location. Power and ground leads should be pulled through the conduit approximately 12" beyond the conduit stub, and be accessible at the time of final wiring. **Note: The 120VAC power lines run up the inside back of the pedestal base (see Diagram C, Mounting Template)**

② Foundation Placement

DIAGRAM G

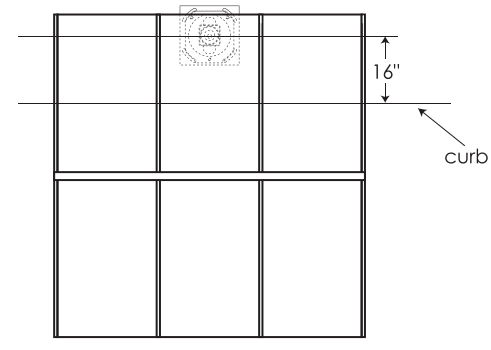

CANOPY/CLEARANCE BAR LOCATION/POSITION (STRAIGHT DRIVE)

DIAGRAM H

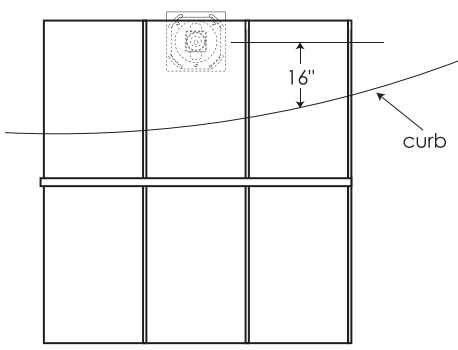

CANOPY/CLEARANCE BAR LOCATION/POSITION (CURVED DRIVE)



1120 N 18th Street • Omaha 68102
402.341.6077 • 402.341.7654 fax

This design and all material appearing hereon constitute the original unpublished work of Omaha Neon Sign Co., Inc. and may not be duplicated, used or disclosed with written consent.

DRAWING # : 126499
PROJECT ID: 25086
SALES PERSON: Andye Nelson
DRAWN BY: wes stephens



Viking Plaza
Cedar Falls, IA
Date: 01.26.21
Revised: 000000

NOTICE:
ALL GRAPHIC REPRODUCTIONS ARE SUBJECTED BY APPROVAL OF AUTHORIZED CLIENT. AS OF APPROVAL BY THE UNDERSIGNED AND DATED PRIOR TO ANY FABRICATION OF PRODUCT. OMAHA NEON SIGN COMPANY, INC. HOLDS ALL AGREEMENTS FINAL AND TO CLIENT APPROVAL.
Signed _____ Date _____
Sales Rep. _____ Date _____

This sign is intended to be installed in accordance with the requirements of Article 600 of the National Electric Code and/or other applicable local codes. This includes proper grounding and bonding of the sign.
UL LIST 110

CLEARANCE BAR

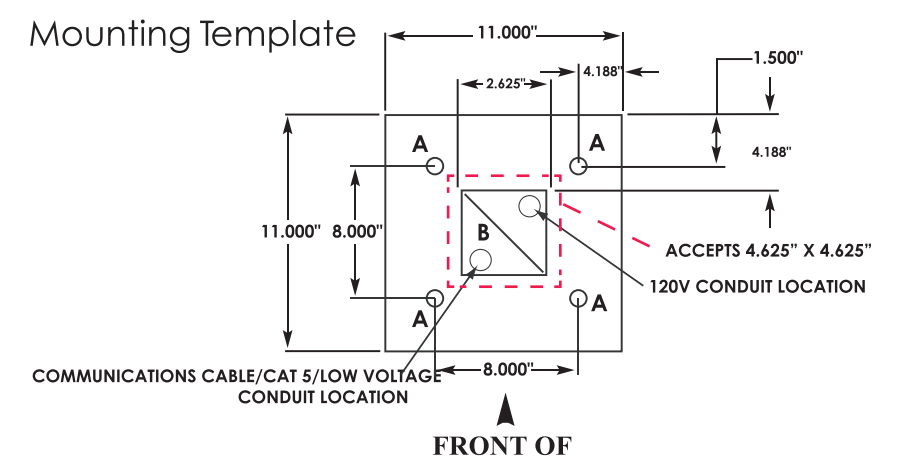
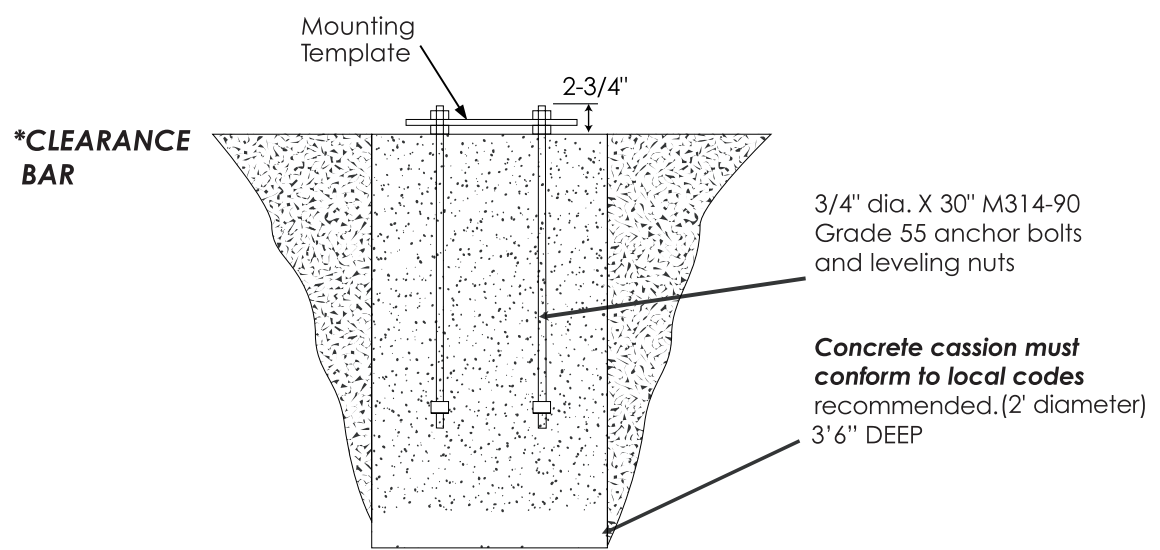
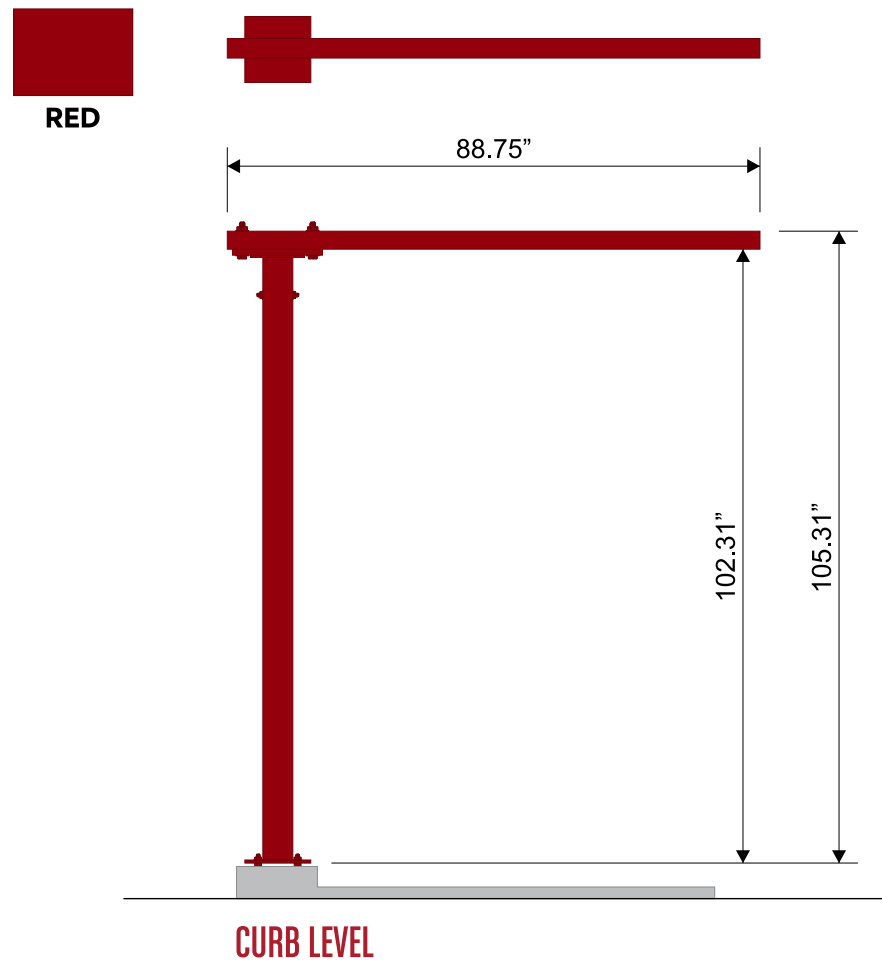

1120 N 18th Street • Omaha 68102
402.341.6077 • 402.341.7654 fax
This design and all material appearing hereon constitute the original unpublished work of Omaha Neon Sign Co., Inc. and may not be duplicated, used or disclosed with written consent.

DRAWING # : 126500
PROJECT ID: 25086
SALES PERSON: Andye Nelson
DRAWN BY: wes stephens

SCOOTER'S
COFFEE DRIVE-THRU

Viking Plaza
Cedar Falls, IA
Date: 01.26.21
Revised: 000000

NOTICE:
ALL GRAPHIC REPRODUCTIONS ARE SUBJECTED BY APPROVAL OF AUTHORIZED CLIENT. AS OF APPROVAL BY THE UNDERSIGNED AND DATED PRIOR TO ANY FABRICATION OF PRODUCT. OMAHA NEON SIGN COMPANY, INC. HOLDS ALL AGREEMENTS FINAL AND TO CLIENT APPROVAL.
Signed _____ Date _____
Sales Rep. _____ Date _____

This sign is intended to be installed in accordance with the requirements of Article 600 of the National Electric Code and/or other applicable local codes. This includes proper grounding and bonding of the sign.
UL LIST 111

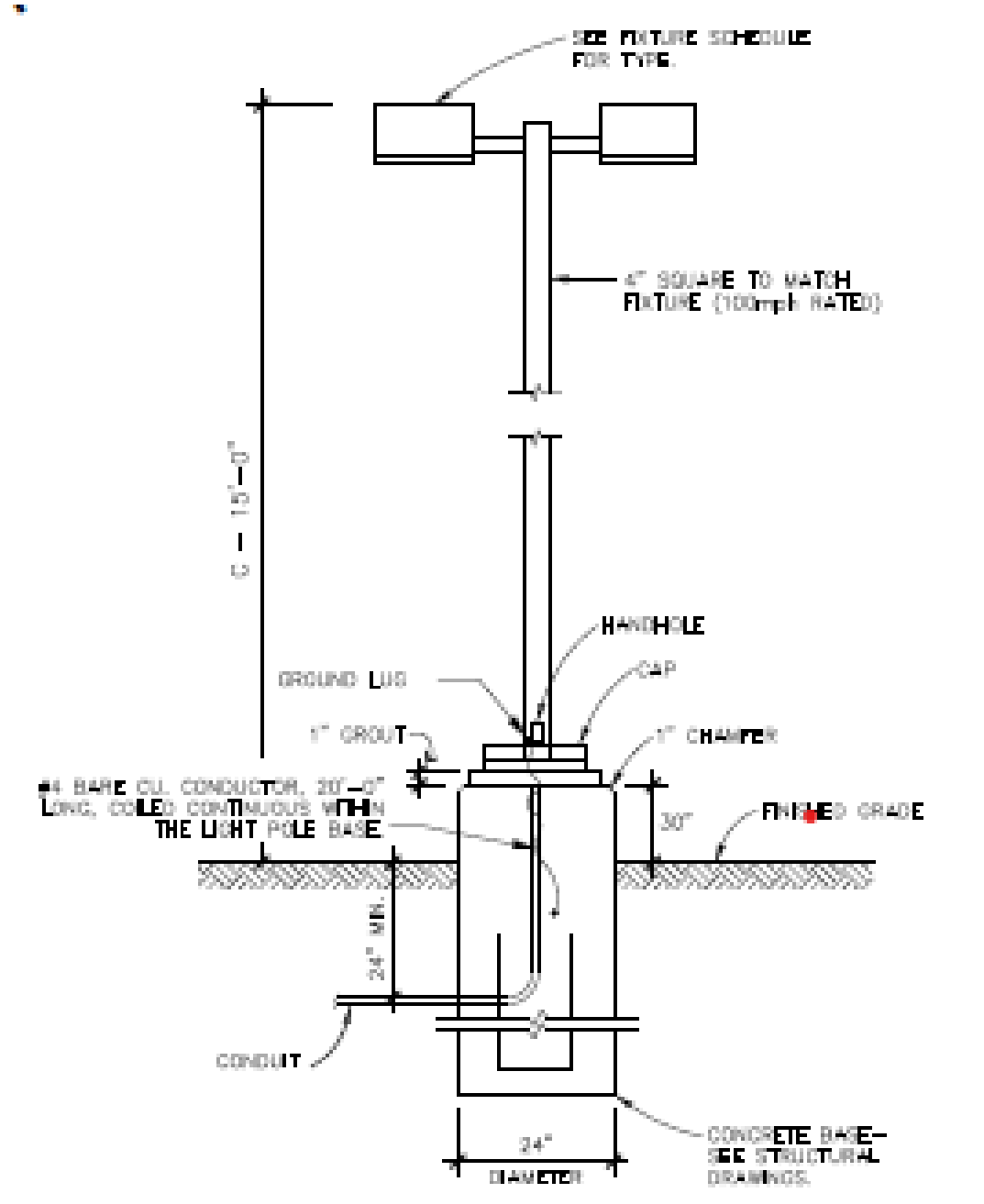
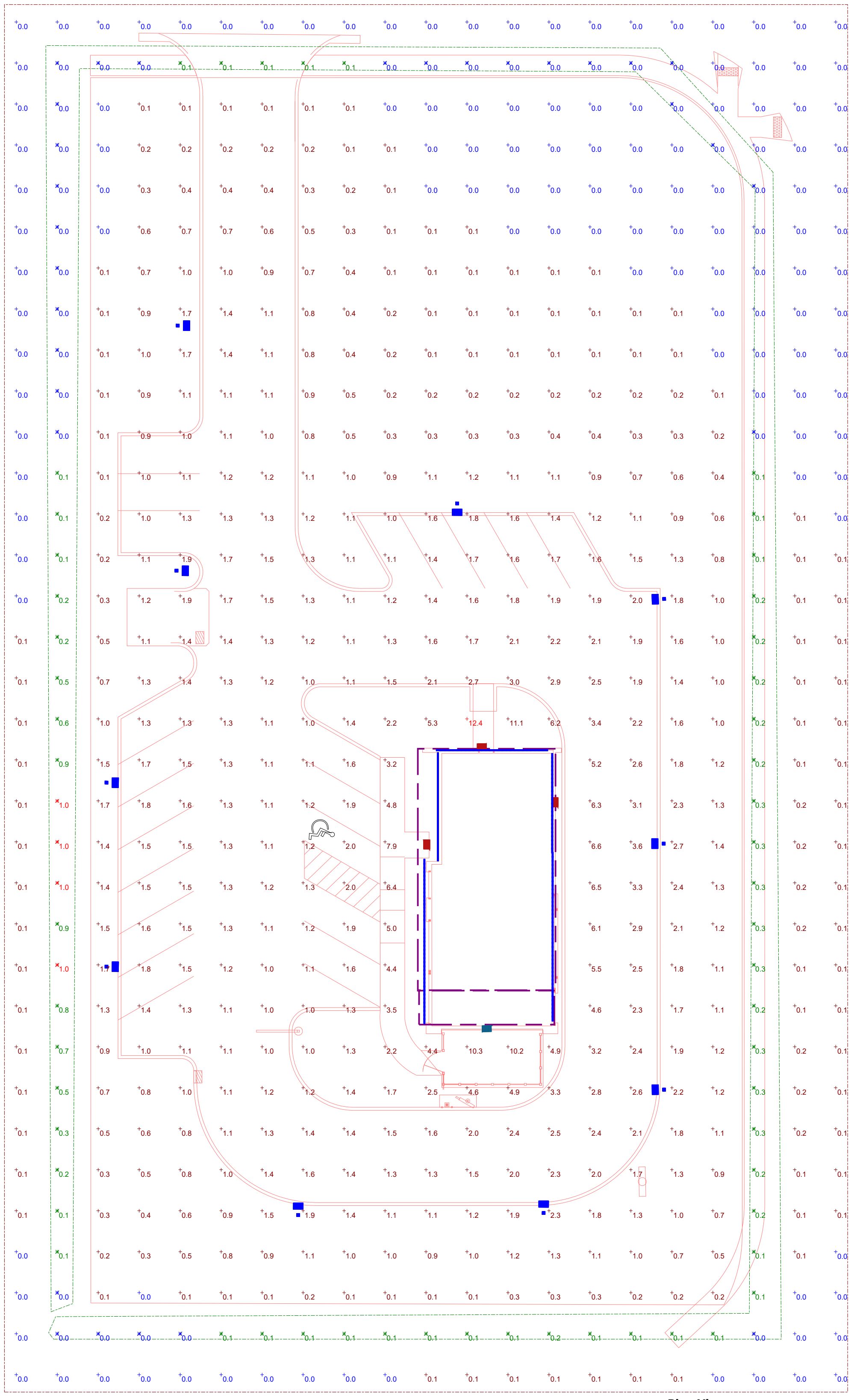

NOTE: CONTRACTOR SHALL PROVIDE NEW POLE BASES WHERE INDICATED ON PLANS. LIGHTING FIXTURE POLE DETAILS AND CONDITIONS ARE FOR ELECTRICAL REFERENCE ONLY. THE POLE AND BASE SHALL BE DESIGNED BY A STRUCTURAL ENGINEER REGISTERED IN THE STATE OF ARIZONA AND BE STAMPED AND SEALED ACCORDINGLY AS A DEFERRED SUBMITTAL.

Symbol	Label	QTY	Manufacturer	Catalog Number	Description	Lamp	Filename	Lumens per Lamp	Lumen Multiplier	LLF	Wattage	Efficiency	Distribution	Polar Plot	Notes
	A	3	Lithonia Lighting	WST LED P1 30K VW MVOLT DS	WST LED, Performance package 1, 3000 K, visual comfort wide, MVOLT, dual switching	LED	WST_LED_P1_30K_VW_MVOLT_DS.ies	1841	1	1	14	100%	TYPE II, VERY SHORT, BUG RATING: B0 - U0 - G0		
	A2	1	Lithonia Lighting	WST LED P2 30K VF MVOLT	WST LED, Performance package 2, 3000 K, visual comfort forward throw, MVOLT	LED	WST_LED_P2_30K_VF_MVOLT.ies	3236	1	1	25	100%	TYPE III, VERY SHORT, BUG RATING: B1 - U0 - G1		
	B	158	Juno Lighting	IO414 15D 5FT 30K 80CRI	SHALLOW CHANNEL NO LENS(1FT SECTION)	IO414 15D 5FT 30K 80CRI (1FT SECTION)	IO414_15D_5FT_30K_80CRI.ies	415	1	1	4.73	100%	DIRECT, SC-0=0.24, SC-90=0.23		
	C	10	Lithonia Lighting	DSX0 LED P2 30K T5W MVOLT HS	DSX0 LED P2 30K T5W MVOLT with houseside shield	LED	DSX0_LED_P2_30K_T5W_MVOLT_HS.ies	3800	1	1	49	100%	TYPE III, SHORT, BUG RATING: B1 - U0 - G1		

Description	Avg	Max	Symbol	Max/Min	Min	Avg/Min
All Points	0.9 fc	12.4 fc	+	N/A	0.0 fc	N/A
Property Line	0.2 fc	1.0 fc	X	N/A	0.0 fc	N/A

APPLIED ENGINEERING GROUP LTD.
7402 East Broad Street
Blacklick, Ohio 43004
Phone: 614.322.7050
Fax: 614.322.7049
MEP Building Consultants



DEPARTMENT OF COMMUNITY DEVELOPMENT

City of Cedar Falls
220 Clay Street
Cedar Falls, Iowa 50613
Phone: 319-273-8600
Fax: 319-273-8610
www.cedarfalls.com

MEMORANDUM

Planning & Community Services Division

TO: Planning and Zoning Commission
FROM: Jaydevsinh Atodaria (JD), Planner I
DATE: April 21, 2021
SUBJECT: Design review of the property in the Central Business District Overlay

REQUEST: Request to approve a Central Business District Overlay Design review for interior renovation and updating façade materials for Taylor Veterinary Hospital.

PETITIONER: CJS Ventures LLC; Owner and Emergent Architects; Architect

LOCATION: 315 State Street

PROJECT #: DR21-004

PROPOSAL

The owner of 315 State Street parcel and the owner of Taylor veterinary Hospital are requesting a site plan design review to remodel some of the interior spaces and update the exterior façade of the existing building. The applicant does not propose any change of use but rather continuing the practice of veterinary hospital by doing minor updates and providing a new makeover to the property. The property is located in the Central Business District Overlay. See current and proposed facade images below. The proposed floor plans of the building are attached.



Proposed



BACKGROUND

315 State Street building was originally constructed in 1930. And several updates were made after the initial construction in 1950 and 1992. Taylor Vet Clinic is the oldest vet hospital in the same location in the state of Iowa. The character of the building originally looked more like a “home office”, and the current proposal is about improving the character of the building by removing the clipped roof gables and creating a more modern and commercial look keeping in mind the styles and the character of the surrounding properties.

This property is located within the C-3, Commercial District Zone (Section 26-172) and the Central Business District Overlay (CBD) (Section 26-189). The CBD requires any “substantial improvement” to an exterior façade to be reviewed by the Planning and Zoning Commission and City Council. A substantial improvement to properties in the Central Business District Overlay is defined in Section 26-189(f):

“Substantial improvement” includes any new building construction within the overlay district or any renovation of an existing structure that involves any modification of the exterior appearance of the structure by virtue of adding or removing exterior windows or doors or altering the color or exterior materials of existing walls. All facade improvements, changes, alterations, modifications or replacement of existing facade materials will be considered a substantial improvement. Included in this definition are any new, modified or replacement awning structures or similar material extensions over the public sidewalk area. A substantial improvement also includes any increase or decrease in existing building height and/or alteration of the existing roof pitch or appearance.”

ANALYSIS

The following is an evaluation of the proposed changes according to the review standards in the Central Business District Overlay Zone:

1. Proportion: This criterion takes into account the relationship of the proposed horizontal elements (such as cornice lines, awnings, and canopies) and vertical elements (such as windows and doors) with the elements of adjacent buildings. Blank walls along the street level are to be discouraged. The applicant is proposing to retain the existing nature of the building and change the roofline, update the exterior façade and some minor interior remodel. The proposal is to enhance the look of the building keeping the use same and most of the building intact. The addition of windows on the second level and the replacement of front doors with an aluminum storefront door on the main level along the

east facade is also part of this proposal. These changes will allow the roofline to be aligned, and add more openings along the second level facing State Street. These changes are not consistent with other storefront design buildings in downtown, as the building was never designed to be a storefront building. The building originally had the impression of a home office and was later converted into a Veterinary hospital.

As per code, exceptions may be allowed for buildings on corner lots where window placement should be concentrated at the corner and maybe reduced along the secondary street façade and for the repurposing of buildings not originally designed as storefronts. The proportions of the proposed windows and doors are not consistent with those in the district and neighboring buildings. Since the building was designed for a home office and not as a storefront building, the applicant is requesting an exception to the window coverage requirement Section 26-189(i)(1) of the code. Staff finds that the proposed design is going to provide a modern look to the building and no major exterior change or the existing use of the building is being altered. **Staff supports an exception to the fenestration requirement in this case.**

2. **Roof shape, pitch, and direction:** The building's roofline is being altered. As per code, the similarity or compatibility of the shape, pitch, and direction of roofs in the immediate area shall be considered in the construction or alteration of a building. The proposal aims to change roofline at South facing dormer and east-facing facade from "clipped gable" to "gable". Part of the proposal also includes updating new shingles (similar to existing shingles) in some area and increase the width of the cantilever bump out. The proposal meets the criteria as there is no major alteration in the roofline or changing roof area. **This criterion has been met.**
3. **Pattern:** The pattern of solid surfaces and openings needs to be considered in the alteration of a building. The applicant is proposing to leave most of the building's facades as is while installing new doors as needed and will be creating more openings on the second level along the State Street façade. The composition of the existing stone pattern along with the cast stone coping on the main level and mixing two types of LP smart sidings will add more patterns to the existing building. Openings will be mostly unchanged, keeping the façade with more materials and fewer openings as the building was not originally designed as a storefront building. In sum, there will be three different patterns on the façade, including two types of LP smart sidings, stone and stucco as major patterns throughout the building. The applicant is attempting to update the existing building similar to other buildings in the surrounding context. **This criterion has been met.**
4. **Building Composition:** The proposed project is not about altering the use of the building and therefore will maintain the existing composition of façades. Few changes will be made to the building walls to retain existing building elements, reduce construction costs, and maintain the integrity of the original design. The proposal mostly includes cosmetic changes to the façade materials and changing roofline, but the majority of the structure will remain as is. **Staff finds the proposed application to be a cosmetic update to the existing composition of the building.**
5. **Windows and transparencies:** The CBD requires new storefront construction have a minimum of 70 percent of the storefront area between two and ten feet in height above the ground level to consist of clear and transparent storefront windows. Modifications to existing storefronts can maintain or expand their transparency percentage but decreasing the area is

discouraged and subject to the discretion of the Planning and Zoning Commission and City Council. Exceptions may be allowed for building on corner lots where window coverage should be concentrated at the corner, but maybe reduced along the secondary street façade, and for repurposing of buildings not originally designed as storefront buildings.

In the case of the subject property, the applicant would like to retain the original context of the building and just update the façade materials, alter roofline, and do a minor interior remodel work for the existing use of Taylor Veterinary hospital and therefore is requesting an exception to the transparency requirements. Also, existing floor plan (shown below) limits the applicant to add any openings on

the main level as this property was never designed as a storefront building but more of a home office, which was then converted into a Veterinary hospital. The applicant will be replacing two entrance doors with new aluminum storefront doors and increase window coverage on the second level facing the State Street, thus slightly increasing the windows along the eastern façade of the building from the existing scenario. The openings along the south wall of the building are not altered and will remain as is. City staff notes that all the windows and aluminum storefront doors proposed will be clear and non-reflective and cannot be

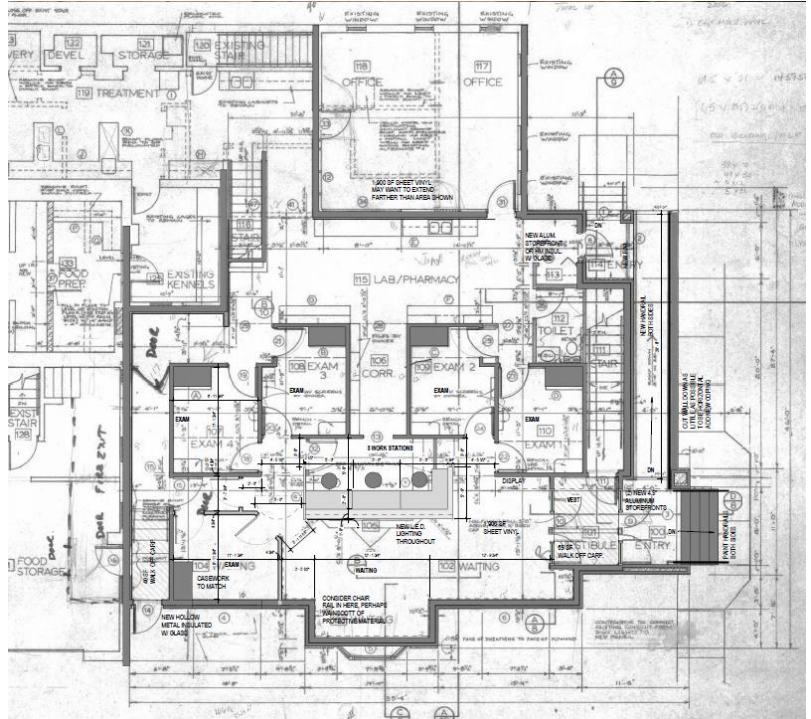

covered with privacy film to at least maintain the bare minimum transparency cover for the building. **Staff finds that the changes proposed will allow the building to remain as is and also creating windows and openings along the main level will be difficult as the floor plan restricts the applicant to add more openings. So, staff recommends approval of an exception to the windows coverage requirements.**

6. **Materials and textures:** For new construction or alteration, building materials should be compatible with the walls and roofs of buildings in the immediate area. Street-facing facades must be comprised of at least 50% brick, stone, or terra cotta as the primary material. And the side and rear walls shall be comprised of at least 25% brick, stone, or terra cotta. Fiber cement, aluminum, metal, pre-formed panels, painted wood, or anything similar may be used up to 35 percent of anyone siding material and up to 40 percent on any other sides of the building as secondary material.

The applicant is requesting an exception to this regulation as the intent of this proposal is not fully altering the building facades but to continue using existing materials on the façade. The proposed renovation would involve having 26 percent of the stone façade (primary material) and 59 percent of LP smart siding material (secondary material) along the eastern face of the building facing State Street. Applicant requests an exception to the required material percentages required along the street side façade as the idea is not to alter any physical

space of the existing building but more about providing a new makeover to the building. City staff finds this as a reasonable request as there is no use being altered for the exiting building. The proposed materials are in keeping with buildings materials in the district and meet the requirements of this section. **Staff finds that the changes proposed will allow the applicant to update the façade for Taylor Vet Clinic, so recommends approval of an exception to the material composition requirements in the code.**

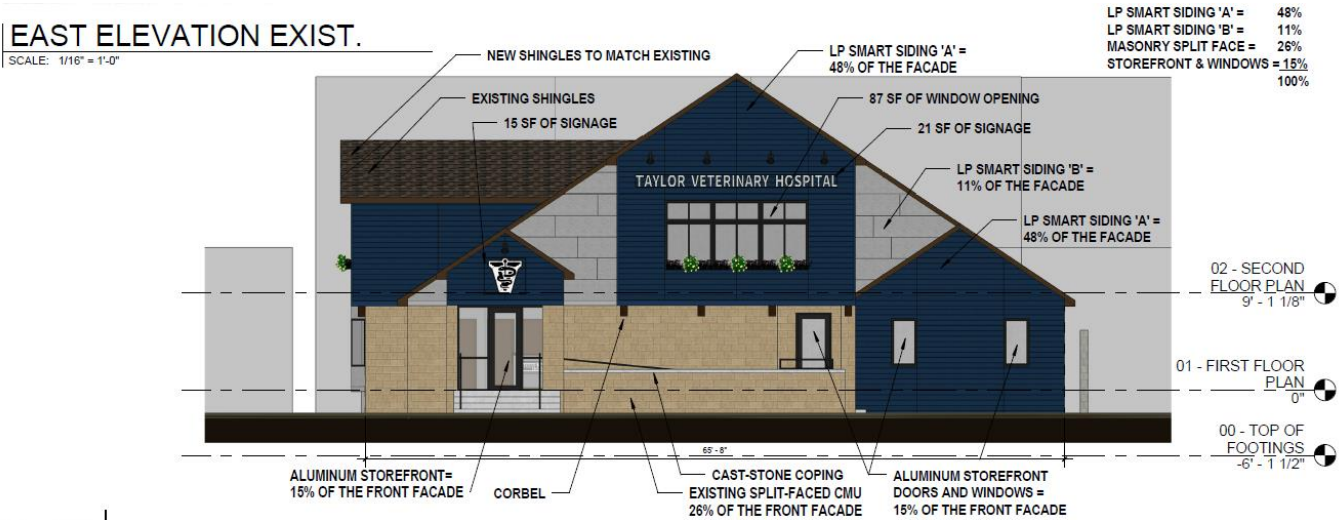

7. **Color:** The proposed color alteration of the subject building will transform the existing ivory and brown color tones on the façade into the mixture of ivory, a tone of blue, and a hint of grey color. The existing stone façade will remain unaltered but the majority of the block and stucco with Tudor detailing's will be replaced with a mixture of blue and grey LP smart sidings. The proposal of new blue and grey tones would enhance the façade of the building. As per code, the similarity or compatibility of existing colors of exterior walls and roofs of buildings in the area shall be considered in the construction or alteration of the building. Buildings in the CBD utilize earth and neutral tones, so other colors can accent and highlight the architectural features of a building. The proposed colors are neutral and compatible with the existing colors of the district. **This criterion has been met.**
8. **Architectural features:** The building is currently being used as a veterinary hospital and a housing unit. The applicant proposes to update the exterior façade of the building with a more modern and commercial look for the business. The proposal includes changing of roofline from "clipped gable" to "gable" roof at South facing dormer and at east-facing façade. The proposal also includes replacement of Tudor detailing's on the facades with composite board siding product giving more of contemporary look to the building and replacement of existing entrance door with aluminum storefront doors. The proposed replacement of windows, the addition of windows on the second level, and change of roofline is consistent with the district and add interest to the building. **This criterion has been met.**
9. **Building entries:** The existing building has two entrances along the eastern wall from State Street and another ingress/egress point along the south wall of the building, which can be accessed from the parking area from the city alley bordering the western lot line of parcel. The proposed renovation includes the replacement of existing exterior doors with new aluminum storefront doors. The proposal does not include any change in the existing building entries to the building. **This criterion does not apply to this review.**

10. Exterior mural wall drawings, painted artwork, exterior painting: No mural is being proposed; **this criterion does not apply for this review.**
11. Signage: The applicant is proposing to update the existing wall sign along the eastern wall on the building by proposing two new wall signs along the eastern wall for the business. The property also has a free-standing sign in the southeast corner of the lot, and there are no plans to change the same at the moment. Walls signs may be approved administratively according to the standards in the code. Wall sign shall not exceed ten percent of the total wall area, and in no case shall exceed ten percent of the area of the storefront. Wall signs on storefronts shall not extend beyond or above an existing sign band or extend over or detract from the architectural features of the building façade, such as cornices, pilasters, transoms, window trim, and similar. (Section 26-189 (j)(4))

The two proposed wall signs will be placed along the eastern wall of the building, with 15 square feet of a logo over the entrance canopy area and about 21 square feet of sign highlighting the business placed just above the lintel level on the second level fronting the State Street. At present, there is one wall sign about 21 square feet in area located on the eastern facade of the building. Other sign details have not been given at this point. The proposed sign area and placements meet the city code standards. City staff notes that a separate sign permit will be required by the applicant or sign company before installing the proposed wall signs. **This criterion has been met.**

12. Use: The current use for the subject property is for a Veterinary Hospital and a housing unit. The use is allowed as per the zoning code. The proposal does not include any change of existing use of the property. **This Criterion has been met.**

TECHNICAL COMMENTS

Downtown Streetscape and Reconstruction Phase 2 project will be reconstructing E.4th Street this summer. Minor closures to 4th and State intersection should be anticipated.

CFU has reviewed the design review for the Taylor Vet Clinic and has no objections. A courtesy mailing was sent to the neighboring properties on April 21, 2021.

STAFF RECOMMENDATION

The Community Development Department recommends approval of the submitted proposal to update the façade, alter roofline and interior remodel work at 315 State Street for Taylor Vet Clinic.

PLANNING & ZONING COMMISSION

Discussion
4/28/2021

Cedar Falls Planning and Zoning Commission

April 28, 2021

Item 8.

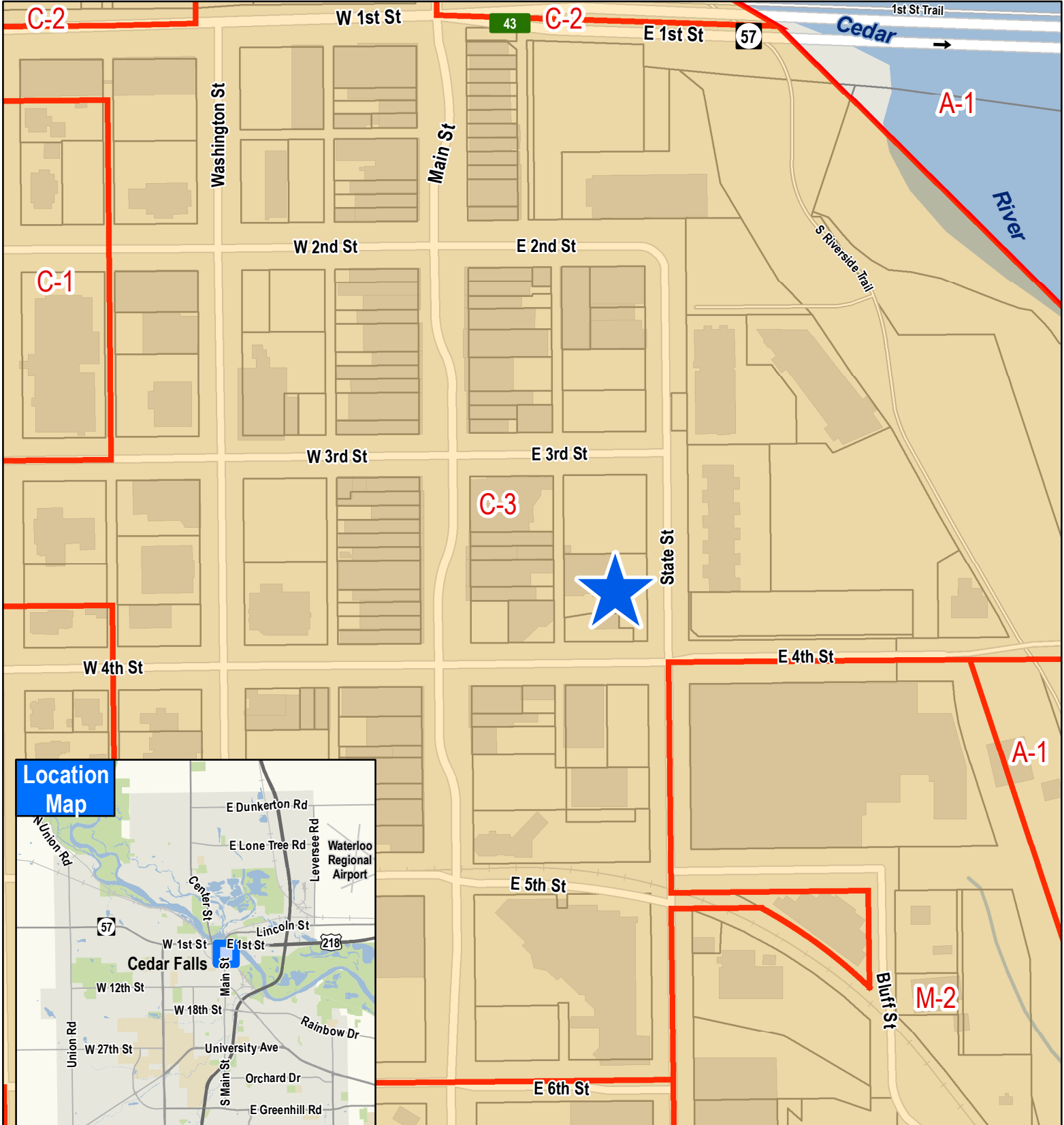

Location Map

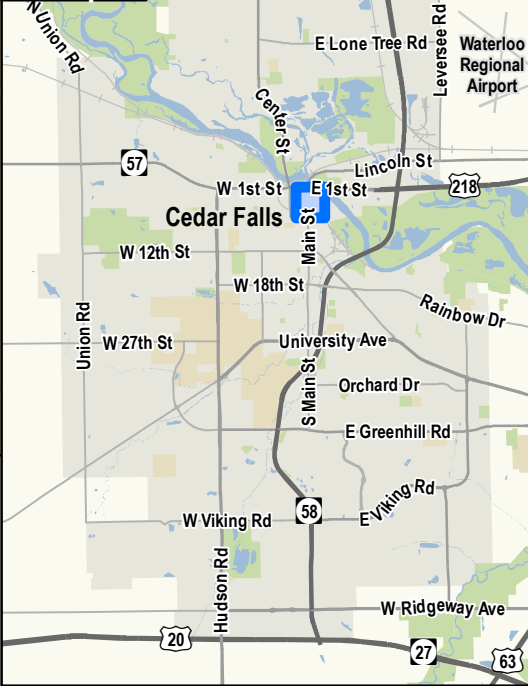

**Central Business District Design Review
for Taylor Vet Clinic
315 State Street**

March 29, 2021

Department of Community Development

Design Review for the Central Business District

City of Cedar Falls

200 Clay Street

Cedar Falls, Iowa 50613

Letter of Intent - Taylor Veterinary Hospital Improvements

315 State Street

Cedar Falls, IA 50613

Review Boards,

Taylor Veterinary Hospital is seeking approval to improve the exterior appearance of their downtown district building along with interior renovations to expand their service and improve their current facility. The site at this time will not be getting improvements as the building location, drive and parking, and utilities to serve the building will all stay in their current design. Jill and Chad Smith are the owners of the building under the name CJS Ventures LLC, and they are also owners of the Taylor Veterinary Hospital practice. They approve these improvements.

Owner: Jill and Chad Smith – CJS Ventures LLC

315 State St, Cedar Falls, IA 50613

jsmith@taylorvet.com 319-277-1883

These improvements aim to bring a more modern look to the exterior and interior of the building, as well as representing to the community that Taylor Vet is a long-term resident of the downtown and plans to be for the foreseeable future. Taylor Vet is a sponsor for many community and downtown events, including the animal pet parade and bark for life events. The story of the practice is very integral to this location and downtown Cedar Falls. This practice has been in this location near downtown Cedar Falls since 1917. **This practice is the oldest vet hospital in the same location in the state of Iowa.**

The general improvements aim to keep with the current shape of the building which is rooted in the history of the buildings located here but improve and modernize upon those looks. Attached you will find some shots of the group of buildings that used to stand in this location, and how these are currently still standing at the rear of the property. Also, the character of the previous ‘home office’ was represented in the style of the building that was constructed in this location and added onto the existing buildings in 1991.

The improvements to the building in general look to improve the character of the building by removing the clipped roof gables and creating a more modern and commercial look as relating to the surrounding architecture. The majority of the existing building is block and stucco, and our approach is to remove the stucco with tudor detailing and replace this with a composite board siding product (LP smart siding) as used on many of the buildings in the Eagle View developments. The signage and color brand the building with the historic Taylor Vet Hospital. We would complete the exterior improvements by replacing the entrances with new aluminum storefront entrances that would provide more vision glass and view into the existing building.

There is no work being done to the site so there is no need for a site plan review so no information has been provided for the site. This would be considered a substantial improvement and we have visited with Karen Howard on how to provide documents for the review. Due to budget restrictions, the existing construction of the building, and the historic nature of the buildings and their design we ask to keep with the existing 'home' style of the commercial building. The proportion and roof shape were taken into account on the front façade as we created a larger step out of the front façade while fixing the clipped front gable (east elevation). We clad this part of the building with the siding product to go with the residential feeling of the building and to compliment the split face base of the building. This also gives a bit of relief in the building composition and avoids flat, continuous facades. Transparency is improved by the replacement of the residential style front entrances with storefront aluminum entrances, but we do not meet the 70% transparency requirements as much of the front façade masonry blocks the program located behind it which is toilets and exam rooms. We also do not have the budget to remove the split face CMU located on the base of the building, but we look to remove some of the angled block wall that guards the ramp. We would cut this down to get a straight masonry look and cap it with cast stone. Below is a thorough description of the scope of work for the exterior of the building

Taylor Vet – General Scope

Exterior Scope:

- Change roof line at South facing dormer, from “clipped gable” to “gable.” Re-roof to the nearest valley.
- At the South Elevation of the 1991 addition, remove stucco areas and replace with LP Smart Siding.
- Change roof line at East facing façade, from “clipped gable” to “gable”. Weave in new shingles to existing. Increase width of “cantilever bump out.” New siding material to be LP Smart Siding.
- At the East Elevation, remove stucco areas and replace with new LP Smart Siding.
- Install new larger window units at the new 2nd level East Elevation “bump out.”
- Remove and replace (2) existing windows at offices on first level in East facing façade.
- Remove and install new aluminum soffit, fascia, and gutters at the 1991 Addition roof edge conditions. Existing roof drip edge to remain in areas of no roof re-work. Soffits at door entrances to remain existing.

- Remove all angled CMU from top of wall adjacent to entrance ramp at East facing façade. Top remaining CMU wall with new cast stone cap. No new railings or guardrails are included at this time.
- Remove and replace both exterior and interior sets of doors at East facing façade vestibule. Includes framing modifications. Door openings to be aluminum storefront material with standard hardware.
- Remove and replace single exterior door at base of entrance ramp at East facing façade. Door opening to be aluminum storefront material with standard hardware and privacy film on the glass.
- Remove vines from existing 91' masonry block. Finish on the existing masonry to remain as is.
- New signage and exterior signage lighting fixtures.
- All windows are to remain existing unless noted otherwise. Exterior door on the south elevation to remain existing.

Thank you so much for your consideration and we look forward to improving the Taylor Vet Hospital structure and bring more value to the downtown district while representing the historical past of our location.

Chad and Jill Smith

Taylor Veterinary Hospital

Attached:

- *List of owners within 200 feet of the project boundary*
- *Images of the existing buildings located on the site which we assume were design inspiration for the 1991 addition.*
- *Images of buildings within 200 feet on State Street.*
- *Colored Images showing current façade and proposed work.*
- *General materials used and dimensions of alterations.*
- ***Site Plan Application not included as there are no site improvements proposed.***

Names and addresses of properties and owners within 200 feet of boundary

- 402 MAIN ST – D SQUARED II LLC – 406 MAINT ST
- 412 MAIN ST – MARILYN K GAEDE & JEFFREY J MARSH
- 116 E 4TH ST – ALLEN D KOEPEL
- 108 E 4TH ST – STONE AND TERRACE LLC
- 318 MAIN ST – SC AND B PROPERTIES LLC
- 316 MAIN ST – PC REAL ESTATE LLC
- 312 MAIN ST – PC REAL ESTATE LLC
- 310 MAIN ST – PC REAL ESTATE LLC
- 302 MAIN ST – RIVER PLACE PROPERTIES II LC
- 226 MAIN ST – K GROUP L C
- 224 MAIN ST – JJ LAND L C / 110 E 3RD ST
- 222 MAIN ST – JJ LAND L C
- 216 MAIN ST – BLACK HAWK LODGE NO 65 AF AND AM
- 214 MAIN ST - BLACK HAWK LODGE NO 65 AF AND AM
- 200 STATE ST – STATE STREET MIXED USE LC
- 300 STATE ST APARTMENTS – STATE STREET RESIDENCES LC
- 406 STATE ST – VIKING PUMP INC
- 415 STATE ST – CLARK J RICKARD AND TWYLA J RICKARD
- 119 E 4TH ST – MMC PROPERTIES LLC





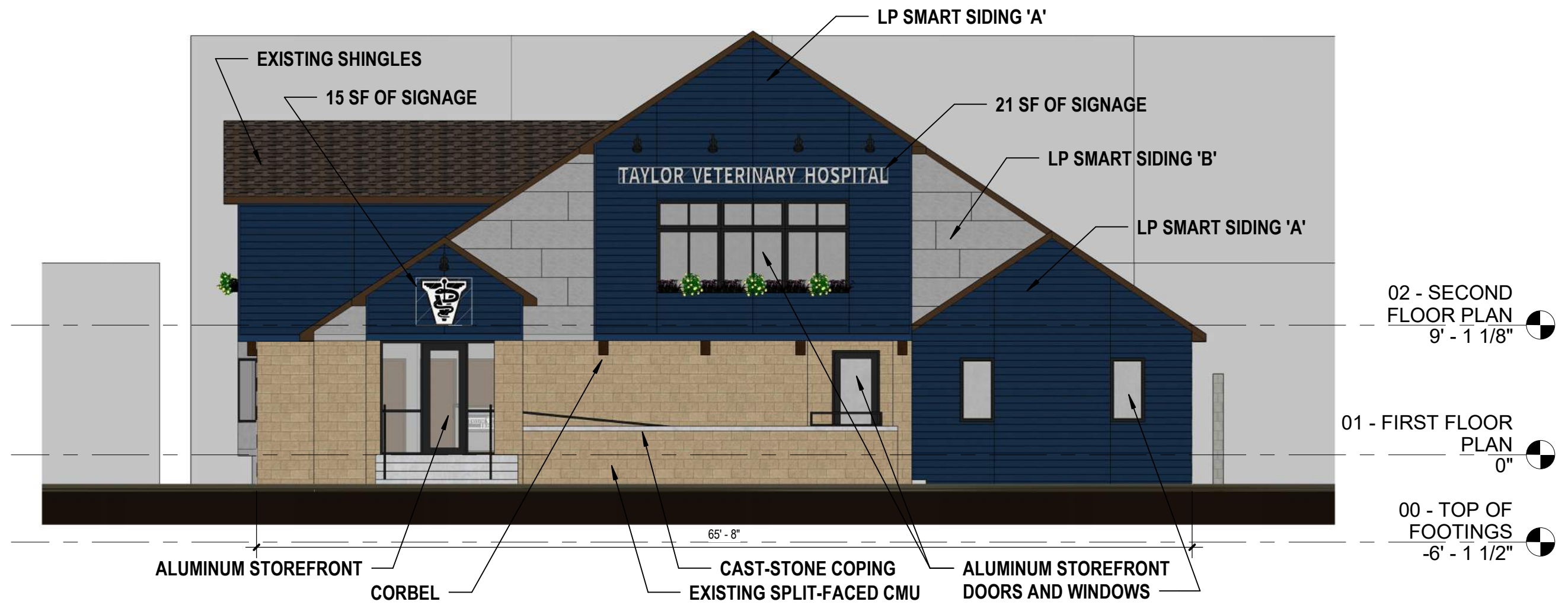

02 - SECOND FLOOR PLAN
9' - 1 1/8"

01 - FIRST FLOOR PLAN
0"

00 - TOP OF FOOTINGS
-6' - 1 1/2"

1 EAST ELEVATION

SCALE: 1/8" = 1'-0"

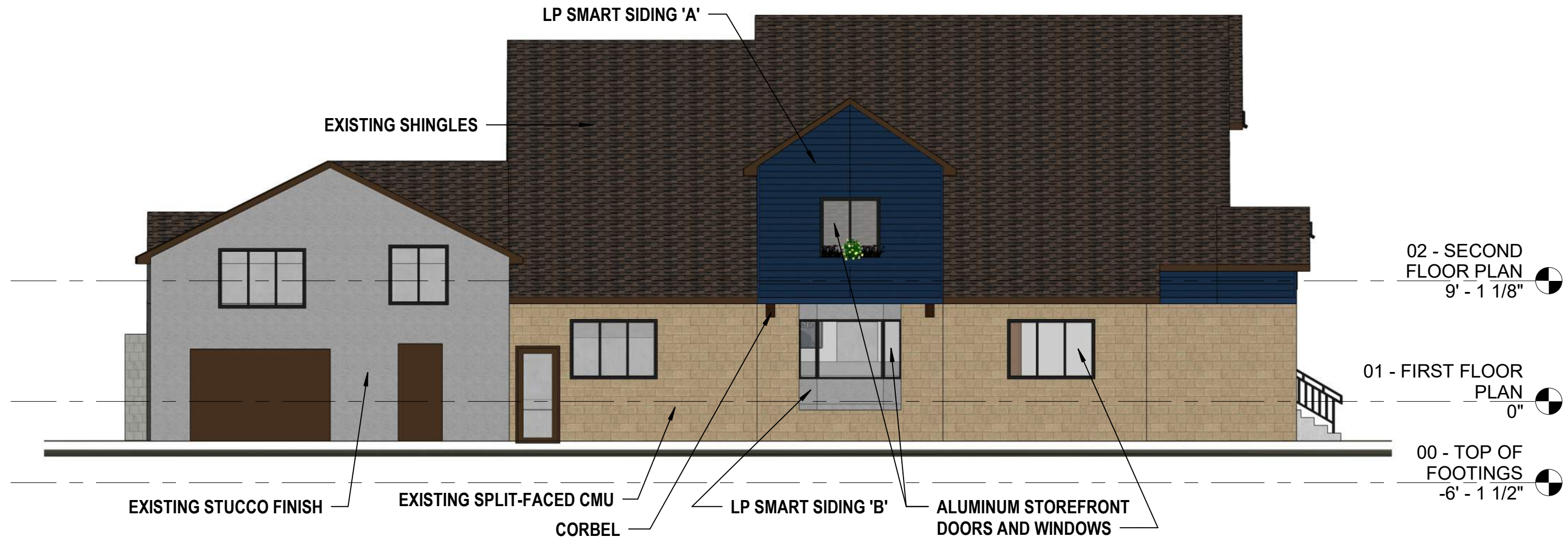

1 SOUTH ELEVATION

SCALE: 1/8" = 1'-0"



TAYLOR VET HOSPITAL
 CEDAR FALLS, IOWA
 ISSUE DATE March 29, 2021





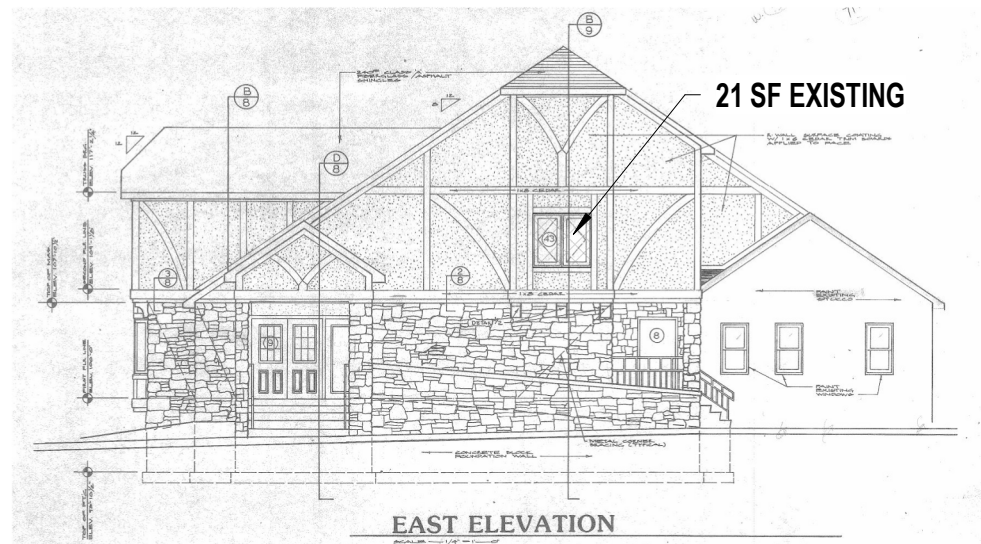

2 EAST ELEVATION EXIST.
SCALE: 1/16" = 1'-0"

LP SMART SIDING 'A' =	48%
LP SMART SIDING 'B' =	11%
MASONRY SPLIT FACE =	26%
STOREFRONT & WINDOWS =	15%
	100%

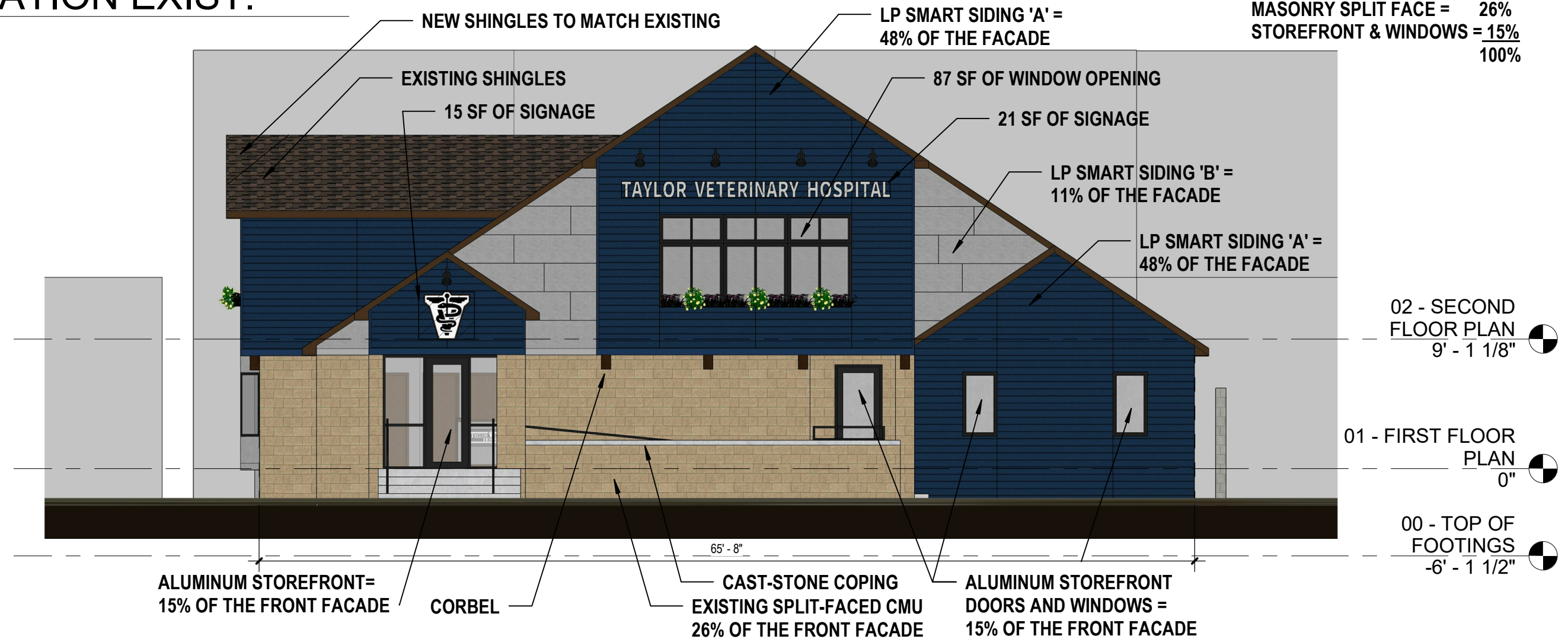

02 - SECOND FLOOR PLAN
9' - 1 1/8"

01 - FIRST FLOOR PLAN
0"

00 - TOP OF FOOTINGS
-6' - 1 1/2"

ALUMINUM STOREFRONT = 15% OF THE FRONT FACADE
CORBEL
65' - 8"
CAST-STONE COPING EXISTING SPLIT-FACED CMU 26% OF THE FRONT FACADE
ALUMINUM STOREFRONT DOORS AND WINDOWS = 15% OF THE FRONT FACADE



TAYLOR VET HOSPITAL
CEDAR FALLS, IOWA
ISSUE DATE March 29, 2021

1 EAST ELEVATION
SCALE: 1/8" = 1'-0"