



AGENDA

City Council Meeting
Republic Community Center, 711 E. Miller
July 21, 2020 at 6:30 PM

Jeff Ussery, Mayor
Brandon Self, Ward I
Garry Wilson, Ward II
Christopher Updike, Ward III
Jennifer Mitchell, Ward IV

Eric Franklin, Ward I
Gerry Pool, Ward II
Matt Russell, Ward III
Jim Deichman, Ward IV

Call Meeting to Order

Opening Prayer

Pledge of Allegiance to the United States Flag

Citizen Participation

Consent Agenda

- [1.](#) Approve June 16, 2020 City Council Minutes.
- [2.](#) As per RSMo. 109.230(4), City records that are on file in the City Clerk's office and have met the retention schedule will be destroyed in compliance with the guidelines established by the Secretary of State's office.
- [3.](#) Approve Utility Billing Adjustments.
- [4.](#) Approve Vendor List.

Board, Commission, and Committee Schedule

Board of Adjustment Meeting August 6, 2020
Planning and Zoning Commission August 10, 2020
City Council Meeting August 18, 2020
City Council Meeting August 25, 2020

Old Business and Tabled Items

- [5.](#) 20-25 An Ordinance of the City Council of the City of Republic, Missouri, Approving Amending the Zoning Code and Official Map by Changing the Classification of Approximately 0.47 Acres, Located at 127 East Mill, from Medium Density Single-Family Residential (R1-M) to Two-Family Residential (R-2).
- [6.](#) 20-26 An Ordinance of the City Council of the City of Republic, Missouri, Approving Amending the Zoning Code and Official Map by Changing the Classification of Approximately 0.47 Acres, Located at 616 North Phelps Avenue, from Medium Density Single-Family Residential (R1-M) to High Density Single-Family Residential (R1-H).

New Business (First Reading of Ordinances)

- [7.](#) 20-27 An Ordinance of the City Council of the City of Republic, Missouri, to Establish a Procedure for Disclosing Potential Conflicts of Interest and Substantial Interests for Certain Officials.
- [8.](#) 20-28 An Ordinance of the City Council of the City of Republic, Missouri, Approving the Annexation of Approximately 5.0 Acres of Land Located at 688 South Kansas Avenue and Adjacent Right-of-Way.

Other Business (Resolutions)

- [9.](#) 20-R-24 A Resolution of the City Council of the City of Republic, Missouri, Awarding the Bid for the Parking Lot and Driveway Paving at the Republic Animal Control Facility.

[10.](#)20-R-25 A Resolution of the City Council of the City of Republic, Missouri, Authorizing the City Administrator to Enter Into an Agreement with Missouri State University for Services Related to the Comprehensive Plan.

[11.](#)20-R-26 A Resolution of the City Council of the City of Republic, Missouri, Authorizing Task Order No. 9 with Burns & McDonnell to Develop and Evaluate the Current Rate Structure, Revenues, and Expenses of the Wastewater Fund to Provide Recommendations for Future Rates, Capital Improvements and Financial Sustainability.

Reports from Staff

Recognition of Mayor

Executive Session: *No further action, other than announcing adjournment by the Mayor, shall take place after an Executive Session that is scheduled as the last matter on the Agenda unless otherwise stated on the Agenda or as allowed per RSMo. 610.02.*

Adjournment

Individuals addressing the Council are asked to step to the microphone and clearly state their name and address before speaking. In accordance with ADA guidelines, if you need special accommodations to attend any city meeting, please notify the City Clerk's Office at 732-3140 at least three days prior to the scheduled meeting. **All meetings are tape recorded for public viewing.**



MINUTES

City Council Meeting

Republic Community Center-Community Room 711 E. Miller

June 16, 2020 at 6:30 PM

- Jeff Ussery, Mayor
- Brandon Self, Ward I
- Garry Wilson, Ward II
- Christopher Updike, Ward III
- Jennifer Mitchell, Ward IV
- Eric Franklin, Ward I
- Gerry Pool, Ward II
- Matt Russell, Ward III
- Jim Deichman, Ward IV

Call Meeting to Order

The regular session meeting of the City Council of the City of Republic, Greene County, Missouri, was called to order by Mayor Jeff Ussery at 6:30 p.m. at the Republic Community Center. Council Members in attendance were: Eric Franklin, Jim Deichman, Garry Wilson, Brandon Self, John Jones, Matt Russell, Charlie Brashers, and Gerry Pool. Newly elected Council Members Christopher Updike and Jennifer Mitchell were present. Others in attendance were: Assistant City Administrator Jared Keeling, Assistant City Administrator Lisa Addington, Police Chief Brian Sells, City Attorney Scott Ison, Assistant Public Works Director Garrett Brickner, Public Information Officer Mike Landis, IT Technician Michael Sallee, and Principal Planner Karen Haynes.

Opening Prayer

Opening prayer was led by Council Member Eric Franklin.

Pledge of Allegiance to the United States Flag

The Pledge of Allegiance was led by Mayor Jeff Ussery.

Citizen Participation

Mayor Ussery opened Citizen Participation at 6:31 p.m. No one came forward so Mayor Ussery closed Citizen Participation at 6:32 p.m.

Consent Agenda

Motion was made by Council Member Wilson and seconded by Council Member Franklin to approve the consent agenda. The vote was 8 Aye-Deichman, Russell, Pool, Franklin, Self, Wilson, Jones and Brashers. 0 Nay. Motion Carried.

1. Approve June 2, 2020 City Council Regular Session Minutes.
2. Approve Vendor List.
3. Approve Utility Billing Adjustments.

Board, Commission, and Committee Schedule

- June 4, 2020 Board of Adjustment Meeting
- June 8, 2020 Planning & Zoning Meeting
- June 16, 2020 City Council Meeting
- July 21, 2020 City Council Meeting

Old Business and Tabled Items

4. 20-24 An Ordinance of the City Council of the City of Republic, Missouri, Amending the Municipal Code of the City of Republic, Missouri, by Amending Title I, "Government Code," Chapter 130, "Municipal Court," Article I, "General Provisions," Regarding the Term of Office for Municipal Judges.



Motion was made by Council Member Pool and seconded by Council Member Franklin to have the second reading of Bill 20-24 by title only. The vote was 8 Aye-Franklin, Pool, Russell, Deichman, Brashers, Jones, Wilson, and Self. 0 Nay. Motion Carried. Scott Ison was available to answer any questions from Council. Council Member Jones motioned for the passage of Bill 20-24. Council Member Deichman seconded. A roll call vote was taken. The vote was 8 Aye-Russell, Pool, Franklin, Deichman, Self, Jones, Brashers, and Wilson. 0 Nay. Motion Carried.

Other Business (Resolutions)

5. 20-R-18 A Resolution of the City Council of the City of Republic, Missouri, Declaring the Results of the June 2, 2020 Municipal Election.

Motion was made by Council Member Jones and seconded by Council Member Brashers to approve Resolution 20-R-18. Mayor Ussery read the election results. The vote was 8 Aye-Self, Franklin, Pool, Wilson, Deichman, Russell, Brashers, and Jones. 0 Nay. Motion Carried.

Recognition of Council Members

Mayor Ussery recognized Council Member Jones and Council Member Brashers for their years of service on City Council. Council Members Brashers and Jones spoke about their time on Council. Mayor Ussery presented them with plaques acknowledging their service to the community.

Swearing-in of Elected Officials

Deputy City Clerk Lisa Addington swore in Mayor Jeff Ussery and Council Members Eric Franklin, Garry Wilson, Christopher Updike, and Jennifer Mitchell.

Election of Mayor Pro-Tem

Council Member Wilson motioned to elect Council Member Matt Russell for Mayor Pro Tem. Council Member Self seconded. The vote was 7 Aye-Franklin, Pool, Deichman, Mitchell, Updike, Wilson, and Self. 0 Nay. 1 Abstain-Russell. Motion Carried.

New Business (First Reading of Ordinances)

6. 20-25 An Ordinance of the City Council of the City of Republic, Missouri, Approving Amending the Zoning Code and Official Map by Changing the Classification of Approximately 0.47 Acres, Located at 127 East Mill, from Medium Density Single-Family Residential (R1-M) to Two-Family Residential (R-2).

Council Member Pool motioned for the first reading of Bill 20-25 by title only. Council Member Wilson seconded. The vote was 8 Aye-Self, Franklin, Pool, Wilson, Deichman, Russell, Mitchell, and Updike. 0 Nay. Motion Carried. Karen Haynes provided an overview of the bill. The applicant, April Swanson, was available to answer questions and spoke in favor of the bill. Mayor Ussery reminded Council that this was a first read and to get with Ms. Haynes with any questions prior to the next meeting.

7. 20-26 An Ordinance of the City Council of the City of Republic, Missouri, Approving Amending the Zoning Code and Official Map by Changing the Classification of Approximately 0.47 Acres, Located at 616 North Phelps Avenue, from Medium Density Single-Family Residential (R1-M) to High Density Single-Family Residential (R1-H).

Council Member Wilson motioned for the first reading of Bill 20-26 by title only. Council Member Russell seconded. The vote was 8 Aye-Self, Franklin, Pool, Wilson, Deichman, Russell, Updike, and Mitchell. 0 Nay. Motion Carried. Karen Haynes provided an overview of the bill. The applicant, Steve Crawford, spoke in favor of the bill. Mayor Ussery reminded

Council that this was a first read and to get with Ms. Haynes with any questions prior to the next meeting.

Other Business (Resolutions)

8. 20-R-19 A Resolution of the City Council of the City of Republic, Missouri, Awarding the Bid for the Fencing and Kennel Construction at the Republic Animal Control Facility.

Motion was made by Council Member Wilson and seconded by Council Member Deichman to approve Resolution 20-R-19. Garrett Brickner provided an overview of the Resolution. The vote was 8 Aye-Self, Franklin, Pool, Wilson, Deichman, Russell, Updike, and Mitchell. 0 Nay. Motion Carried.

9. 20-R-20 A Resolution of the City Council of the City of Republic, Missouri, Awarding the Bid for the Observation Cages Construction at the Republic Animal Control Facility.

Motion was made by Council Member Self and seconded by Council Member Franklin to approve Resolution 20-R-20. Garrett Brickner provided an overview of the Resolution. The vote was 8 Aye-Self, Franklin, Pool, Wilson, Deichman, Russell, Updike, and Mitchell. 0 Nay. Motion Carried.

10. 20-R-21 A Resolution of the City Council of the City of Republic, Missouri, Awarding the Bid for the Purchase of Network Switching Hardware.

Motion was made by Council Member Self and seconded by Council Member Deichman to approve Resolution 20-R-21. Michael Sallee provided an overview of the Resolution. The vote was 8 Aye-Self, Franklin, Pool, Wilson, Deichman, Russell, Updike, and Mitchell. 0 Nay. Motion Carried.

11. 20-R-22 A Resolution of the City Council of the City of Republic, Missouri, Approving the Audit Report for the Fiscal Year Ended December 31, 2019.

Motion was made by Council Member Deichman and seconded by Council Member Russell to approve Resolution 20-R-22. Debbie Parks provided an overview of the Resolution and auditor Jon Cummins discussed the details of the audit report. The vote was 8 Aye-Self, Franklin, Pool, Wilson, Deichman, Russell, Updike, and Mitchell. 0 Nay. Motion Carried.

Finance Report

Finance Director Debbie Parks presented the Finance Report.

Reports from Staff

Report from Assistant City Administrator:

Assistant City Administrator Jared Keeling welcomed the new members of Council.

Assistant City Administrator Jared Keeling updated Council on the progress of the Animal Control facility's construction.

Report from Mayor:

Mayor Ussery spoke about Springfield Police Officer Mark Priebe, who was injured in the line of duty. Mayor Ussery shared his thoughts and prayers are with Officer Priebe and his family as he works towards recovery.

Report from Council:

Council Member Eric Franklin congratulated Council Members Brashers and Jones as they end their terms of office and thanked the voters for their participation.

Executive Session:

Motion was made by Council Member Deichman and seconded by Council Member Franklin at 7:56 to go into Executive Session under RSMo 610.021.3 Hiring, firing, promotion or disciplining personnel. Closed session. Closed vote. Closed record. A roll call vote was taken. The vote was 8 Aye – Franklin, Wilson, Russell, Mitchell, Updike, Self, Deichman, and Pool. 0 Nay. Motion carried.

Motion was made by Council Member Self and seconded by Council Member Russell to adjourn the Executive Session Meeting at 8:30 p.m. A roll call vote was taken. The vote was 8 Aye-Deichman, Russell, Updike, Franklin, Self, Pool, Mitchell, and Wilson. 0 Nay. Motion carried.

DRAFT



Record Destruction Request Form

MISSOURI RETENTION MANUAL CODE	NAME/DATE OF RECORDS TO BE DISPOSED	DATE(S) OF DOCUMENTS	RETENTION TIME NEEDED FOR RECORD
GS 042 Volunteer Worker Records	Animal Control	2009, 2010	3 years after separation
GS 007 Accounts Payable Records	Animal Control	2000, 2004, 2007-2009 2012-2016	Completion of audit
0102 Animal Control Cards	Animal Control records	2013-2017	2 years
GS 067 Vehicle Ownership and Maintenance Records	Truck records-vehicle has been sold	2000	Retain titles, licenses, warranties, and maintenance records until vehicle is sold or disposed of. Retain registration records until superseded or disposition of vehicle.
GS 012 Correspondence	Animal Control	2016	1 year
0104 Investigation Logs and Reports	Animal Control	2006-2008, 2013-2017	2 years
0101 Animal Bite Records	Animal Control Records	2008, 2015	2 years
GS 085 Meeting Records (Internal)	Police Cadet Meetings	2005	3 years
GS 076 Administrative Reports	Administrative Reports	1999	After Audit
GS 018 Records Management Records	Police-May include, but not limited to: procedural guidelines, records retention schedules, inventory reports, transfer agreements, disposal lists, destruction	2003-2005	Retain permanently all inventories; disposal lists; destruction



Record Destruction Request Form

	authorizations, and correspondence.		authorizations and transfer agreements. Other records: Retain until superseded or no longer useful.
GS 085 Meeting Records (Internal)	Police Meetings	2002	3 years
GS 054 Fixed Assets Inventory	Police Inventory Lists-obsolete	2003	Retain current inventory in office until superseded. Retain superseded inventories through Completion of Audit.
GS 076 Administrative Reports	Police Annual Summary	1999-2004	Completion of Audit
GS 072 Calendars and Scheduling Records	City and Event Calendars-May include, but is not limited to: time, location, and topic of meetings, appointments, or events; names and phone numbers of participants of meetings or events; prioritized daily tasks; travel schedules.	2002-2018	1 year
1401 Event Files	Parks and Recreation Events	2006-2014	5 years after expiration or cancellation of lease
GS 014 Mailing Lists	Obsolete address and email lists	1999-2016	Destroy when superseded or obsolete
GS 004 Budget Preparation Records	Budget preparation to include: correspondence, budget requests, proposal and instructions, computer reports, notes, staff reports, worksheets, surveys, and	2007-2018	Completion of audit



Record Destruction Request Form

	other related materials.		
GS 007 Accounts Payable Records	May include: correspondence, reports, invoices, statements, vouchers, purchase orders, refund files, payment authorizations, receipt records, canceled checks or warrants, and similar documents.	2007-2018	Completion of audit
GS 037 News Releases	May include news releases announcing routine events or actions carried out within the scope of existing policies	2009-2017	Retain policy and historic news releases permanently. Retain routine news releases 2 years
GS 085 Meeting Records (Internal)	City Meetings	2016	3 years
GS 012 Correspondence	All City non-policy correspondence- May include: incoming and outgoing letters, memoranda, notes, acknowledgements, notices, non-Sunshine requests for information or publications, enclosures, and attachments.	2018	1 year
GS 022 Public Notice Records	May include: public or legal notices, certificates, affidavits of publication, and similar documents	2013-2014	3 years
0039 Petitions	May include petitions of initiative, referendum, recall, vacation of public rights of way, etc	2008, 2012	5 years
GS 008 Accounts Receivable	May include: Sales tax/Use tax distribution, reports, receipts, invoices, awards, logs, lists, summaries, statements and similar records. Information may include: receipt amount, date, invoice number, name,	2013-2018	Completion of Audit



Record Destruction Request Form

	account number, account balance, adjustment, and similar data.		
GS 036 Publications	Parks and Recreation Event Publications	2004-2018	Retain brochures, pamphlets, and leaflets until superseded or obsolete.
GS 038 Scrapbooks, Photographs and Clippings	Photographs and clippings with no historical value.	2000-2017	Retain as needed.
GS 053 Fee Records	Proposed Fee Changes	2004-2017	Completion of audit
GS 065 Participant Registration and Attendance Records	Parks and Recreation team rosters and swim lesson registrations.	2002-2016	3 years
GS 073 Annual Financial Statements	Parks and Recreation program Income-Expense Reports	2002-2014	Retain 5 years
1401 Event Files	Parks and Recreation Special Events	2006-2014	5 years after expiration or cancellation of lease
1403/1404 Facility Event and Recreation Program Scheduling and Reservation File	Aquatic Center Reservations	2005-2014	5 years
GS 006 Subsidiary Ledgers	Journals, Registers, Monthly Ledgers, Accounting Summary Report File, Revenue Sharing, Trial Balance Fund	2014-2016	Completion of Audit
GS 009 Purchasing Records	Purchase Orders Ledger, Purchasing Requests, Requisitions, Authorizations, Material and Cost specifications, Acquisition Orders	2015-2016	3 years plus completion of audit
GS 010 Banking and Investment Records	Account Statements, Deposit books, Deposit and Withdrawal Slips, Cancelled checks, Check Registers, Passbooks, Statements and Receipts for Interest Income; Monthly Statements; Investment	2017	Completion of audit plus 1 year



Record Destruction Request Form

	Returns; Certificates of Deposit; Treasury Bills		
GS 011 Receipts	Copies of receipts issued by the office to persons paying fees, turning over funds, or for the accounting of petty cash expenses.	2000-2018	Completion of Audit
GS 015 Postal Records	May include: postal meter records, receipts for registered and certified mail, insured mail, special delivery receipts and forms, loss reports, and related items.	2016-2018	1 year
GS 070 Expense Reimbursement Records	Travel Vouchers; Expense Reports; Uniform Allowance; Equipment Allowance	2010-2017	Completion of Audit plus 1 year
GS 057 Insurance Claims Files	Damage and Loss Report; Accident Report (government-owned) vehicle	2008-2009	10 years if legal action is taken after disposed or date of last action, 5 years plus legal review if no legal action
1614 Service Interruption Records	Records documenting the interruption of utility services	2000-2016	3 years
1611 Meter Reading Summary Reports	Monthly summary of meter readings by customer account number for utility consumption	1996-2014	5 years

Date	Customer	Overread/Leak	Leak In	Water Gallons Adjusted	Amount Adjusted	Sewer Gallons Adjusted	Amount Adjusted
5/5/2020	Kathy Samsel	Leak	Under house	2,825	10.06	5,650	\$53.51
5/5/2020	Nina Miles	Leak	Service Line	46,635	166.02	93,270	\$883.27
5/5/2020	Keith Steuber	Leak	Toilet	1,222	4.35	1,222	\$11.57
5/5/2020	Aleigha Sherron		Sewer Credit for Power washing	-	0.00	6,100	\$57.77
5/5/2020	Misty Mixon	Leak	Toilet	3,400	12.10	3,400	\$32.20
5/5/2020	Robert Arnett	Leak	Toilet	12,905	45.94	-	\$0.00
5/5/2020	Daniel Imhof	Leak	Toilet	4,835	17.21	4,835	\$45.79
5/5/2020	Katherine Martin	Leak	Service line for washer	2,255	8.03	-	\$0.00
5/8/2020	St George Catholic Church	Leak	Toilet	1,735	6.18	1,735	\$16.43
5/19/2020	Roger Poole	Leak	Refrigerator Line	2,450	8.72	4,900	\$46.40
5/19/2020	Charles & Wilma Kincade	Leak	Toilet line	3,284	11.69	3,284	\$31.09
5/19/2020	Heather Pride	Overread		4,150	14.77	8,300	\$78.60
5/19/2020	Meadors Funeral Home	Leak	Toilet	5,750	20.47	5,750	\$54.45
5/19/2020	Randall & Emma Sneed	Leak	Refrigerator Line	1,500	5.34	3,000	\$28.41
5/19/2020	Savanna & Donnie Lodwick	Leak	Toilet	2,042	7.27	2,042	\$19.33
5/19/2020	Christian Beck	Leak	Outside Faucet	4,150	14.77	8,300	\$78.60
5/19/2020	Delrea Jones	Leak	Service line under tub	4,600	16.38	4,600	\$43.56
5/20/2020	Janey Donaldson	Leak	Service line	-	0.00	10,000	\$96.59
5/20/2020	Randa Brooks	Average adjustment		-	0.00	2,700	\$27.46
5/20/2020	Scott Vandyke	Sewer billed incorrect		-	0.00	5,200	\$51.14
5/20/2020	Amy & Kenneth McCown	Leak	Toilet	-	0.00	2,300	\$21.78
5/21/2020	Michael & Lorna Lanphier	Sewer billed incorrect		-	0.00	6,200	\$58.71
5/22/2020	Turner Building & Development	Overread		2,871	6.20	-	\$0.00
5/22/2020	Donna & Ralph Belitz	Dead meter		10,670	37.99	-	\$0.00
5/27/2020	Rex Pittman	Leak	Service line	3,800	13.53	7,600	\$71.97
5/27/2020	Thomas & Lenora Bernauer	Overread		7,500	26.70	-	\$0.00
5/27/2020	Bowers Brothers Properties	Leak	Service Line	6,750	24.03	13,500	\$127.85
5/28/2020	Scott & Melanie Munder	Sewer average adjustment		-	0.00	600	\$5.69
6/3/2020	Larissa Jackson	Leak	Service Line	50,600	180.14	-	\$0.00
6/3/2020	Brenda Morrison	Leak	Toilet	3,055	10.88	-	\$0.00
6/11/2020	Kylie Koskovich	Leak	Service Line	3,840	13.67	-	\$0.00
6/18/2020	Thomas & Judy Gyles	Leak	Service Line	3,967	14.12	7,933	\$75.13
6/18/2020	Sheryl Anderson	Leak	Toilet	5,050	17.98	5,050	\$47.82
6/18/2020	Trumel & Cawanda Cox	Leak	Toilet	2,300	8.19	2,300	\$21.78
6/18/2020	Scott Vandyke	Sewer billed incorrect		-	0.00	4,200	\$48.12
7/6/2020	Michael Morelock	Leak	Service Line	4,020	14.31	-	\$0.00
7/6/2020	John Boston	Leak	Outside Faucet	2,450	8.72	-	\$0.00
7/6/2020	Benjamin Kienenberger	Leak	Under sink/Toilet	2,450	8.72	-	\$0.00
7/6/2020	PDL Property Group LLC	Leak	Hot Water Tank	4,100	14.60	8,200	\$77.65
7/6/2020	Elmo & Wilma Chilcutt	Leak	Toilet	1,830	6.51	-	\$0.00
7/6/2020	Kylie Koskovich	Leak	Service Line	4,575	16.29	-	\$0.00
7/6/2020	Brian Taylor	Leak	Toilet	1,700	6.05	1,700	\$16.10
7/6/2020	Vince Gronski	Leak	Toilet	4,960	17.66	4,960	\$46.97
7/6/2020	Michael Shanks	Leak	Service Line	3,950	14.06	-	\$0.00
7/6/2020	Daniella Harmon	Leak	Toilet	13,050	46.46	-	\$0.00

REPUBLIC

M I S S O U R I

Vendor Audit Report

For the City of Republic

Date Range: 06/01/2020 - 06/30/2020

Vendor No. & Name	Added	Added User
07024 - 1st Due Emergency Response Solutions LLC	06/04/2020	Rachel Reich-Graef
07026 - Mark/Kristin Tuterschlager	06/04/2020	Rachel Reich-Graef
07028 - MO Ridge Distillery LLC	06/09/2020	Rachel Reich-Graef
07030 - Rodhouse Lock LLC	06/10/2020	Rachel Reich-Graef
07031 - Galco Industrial Electronics	06/10/2020	Rachel Reich-Graef
07032 - Ind-Concepts LLC	06/11/2020	Rachel Reich-Graef
07033 - American Welding & Gas, Inc.	06/11/2020	Rachel Reich-Graef
07034 - Panda Restaurant Group, Inc.	06/11/2020	Rachel Reich-Graef
07039 - City Wide Construction Products Co.	06/12/2020	Rachel Reich-Graef
07042 - John Kail, Attorney	06/12/2020	Rachel Reich-Graef
07043 - Positive Concepts, Inc.	06/12/2020	Rachel Reich-Graef
07045 - Studio Fitness Nixa LLC	06/12/2020	Rachel Reich-Graef
07046 - Schroer Manufacturing Co.	06/17/2020	Rachel Reich-Graef
07047 - ZOLL Worldwide Headquarters	06/17/2020	Rachel Reich-Graef
07077 - AIM Distributing, LLC	06/29/2020	Rachel Reich-Graef



AGENDA ITEM ANALYSIS

Project/Issue Name: 20-25 An Ordinance of the City Council of the City of Republic, Missouri, Approving Amending the Zoning Code and Official Map by Changing the Classification of Approximately 0.47 Acres, Located at 127 East Mill, from Medium Density Single-Family Residential (R1-M) to Two-Family Residential (R-2).

Submitted By: Community Development Department

Date: June 16, 2020

Issue Statement

April and Bryan Swanson have applied to change the Zoning Classification of approximately point four-seven (**0.47**) acres of property located at 127 East Mill from **Medium Density Single-Family Residential (R1-M) to Two-Family Residential (R-2)**.

Discussion and/or Analysis

The property subject to this Rezoning Application is comprised of approximately point four-seven (**0.47**) acres of land located at 127 East Mill. The property is currently vacant, containing no residential or accessory structures; the Applicant has expressed interest in building a duplex on the parcel.

The following paragraphs contain brief analyses of present site conditions as well as the proposal's relationship to **adopted plans of the City**.

Consistency with the Comprehensive Plan

The City's Comprehensive Plan generally encourages the expansion of residential development through proactive rezoning of land at appropriate locations. Appropriate locations are described generally throughout the Plan, with regard to the **relationship of land at particular locations to infrastructure capable of supporting various intensities and densities of uses**.

The Plan more particularly describes appropriate future land uses through the depiction of a "**Future Land Use Map**" (FLUM). In this case, the FLUM depicts the subject property as having a **Main Street District FLUM** designation. The City's Adopted 2005 Land Use Plan has identified the "**Main Street District**" Future Land Use Map designation as a Mixed-Use area described as, "**Downtown Republic; mix of office, retail commercial, multi-family and loft residential.**"

The Main Street District was introduced in the Land Use Plan to accommodate future recommendations from a Main Street Development Plan aimed to guide development in the areas surrounding Main Street. This plan's goal was to create new regulations for new development and redevelopment by

creating a new zoning district, Main Street District (MSD); although the Main Street District was codified as a new zoning district, the area identified in the FLUM does not contain any MSD zoning.

The 2005 Land Use Plan identifies Land Use Goals and Objectives relating to residential development, as follows:

- **Goal:** Cost-effective Private Development Density. Encourage higher density development that will reduce the amount of infrastructure and cost to the developer and reduce the maintenance costs by the City.
 - **Objective:** Use the Land Use Plan to promote and guide the development of land at higher densities to reduce the amount of infrastructure constructed within the City.
 - **Policies:**
 - Plan for higher density development that will reduce the cost of maintenance of new infrastructure improvements, such as water, sanitary sewer, stormwater and roads.
- **Goal:** Encourage the development of Infill Housing
 - **Objective:** Promote infill housing development
 - **Policies:**
 - Promote infill development as a means of maximizing existing infrastructure and encouraging reinvestment in existing neighborhoods
- **Goal:** Diversify the Republic Housing Market.
 - **Objective:** Promote all types of residential development.
- **Goal:** Improve the quality of all types of housing in the City.
 - **Objective:** Encourage the development of high-quality housing regardless of the size, type, and density of housing being constructed.

The 2005 Land Use Plan identifies “Neighborhood Principles and Development Guidelines,” which “provide guidance for how a mixture of land uses can work together to create community.”

- **Principle:** Republic should be a full-service community for a diverse population consisting of neighborhoods designed for human interaction.
 - **Guideline:** A range of housing types and sizes to accommodate household of all ages and sizes should be provided in each Republic neighborhood. A mix of housing types within a neighborhood creates visual and economic variety as well as opportunities for a more diverse population.

The general trend of development in the vicinity of the subject property, along East Mill and surrounding streets is that of a neighborhood of well-established, single-family dwellings.

Compatibility with Surrounding Land Uses

The subject property is surrounded by Medium Density Single-Family Residential (R1-M) Zoning to the north, south, east, and west. The adjacent properties appear to be utilized as single-family residences, with the exception of the property located to the north at the corner of South Pine Avenue and East Elm Street, which appears to be utilized as a multi-family complex.

The land uses permitted in the Two-Family Residential (R-2) Zoning District include single-family dwellings, zero lot line dwellings, duplexes/two-family dwellings, and residential accessory structures.



Capacity To Serve Potential Development and Land Use

Municipal Water and Sewer Service: The parcel contained a single-family home until several years ago when the home was demolished; the home was served by City of Republic water and sanitary sewer service. The site was previously served by a six (6) inch water main and eight (8) inch sanitary sewer main located along East Mill Street. The sanitary sewer flows to the Shuyler Creek Lift Station and then through a force main to the Wastewater Treatment Facility; the Lift Station and Treatment Facility currently have capacity to serve the site. The City’s water system currently has capacity to serve a potential duplex at this location.

Transportation: A Traffic Impact Study (TIS) was not required for the Rezoning Application due to the very low increase in traffic volumes for a single parcel, zoned for Two-Family Occupancy.

Floodplain: The subject parcel **does not** contain a Special Flood Hazard Area (SFHA/Floodplain).

Sinkholes: The subject parcel **does not** contain any identified sinkholes.

Extent to which Proposed Amendment Creates Nonconformities

Any existing single-family residential uses presently conducted on the subject property would be permitted to continue as is at the time of rezone until such time as the use is altered in a way that would remove that lawfully existing nonconforming status. Types of alterations that would cause the removal of that status include redevelopment, expansion of the nonconforming use, substantial destruction of the nonconformity, etc.

Recommended Action

Staff considers the **proposed Zoning Map Amendment (Rezoning)** to be generally consistent with the **goals and objectives of the Comprehensive Plan**, generally consistent with the **trend of residential development in the vicinity of the site**, generally **compatible with surrounding land uses**, and **able to be adequately served by municipal facilities**. Based upon this analysis (performed without the benefit of evidence and testimony of a public hearing), **Staff recommends the approval of this application.**

AN ORDINANCE OF THE CITY COUNCIL OF THE CITY OF REPUBLIC, MISSOURI, APPROVING AMENDING THE ZONING CODE AND OFFICIAL MAP BY CHANGING THE CLASSIFICATION OF APPROXIMATELY 0.47 ACRES, LOCATED AT 127 EAST MILL, FROM MEDIUM DENSITY SINGLE-FAMILY RESIDENTIAL (R1-M) TO TWO-FAMILY RESIDENTIAL (R-2)

WHEREAS, the City of Republic, Missouri, (herein called the “City” or “Republic”) is a municipal corporation and Charter City located in Greene County, Missouri, being duly created, organized, and existing under the laws of the State of Missouri; and

WHEREAS, an application for amendment to the Zoning Code and Official Zoning Map to rezone real estate located at 127 East Mill and comprising approximately 0.47 acres from Medium Density Single-Family Residential (R1-M) to Two-Family Residential (R-2), was submitted to the Community Development Department Staff by April and Bryan Swanson (hereinafter “Applicant”); and

WHEREAS, the Community Development Staff did thereafter submit said application to the Planning and Zoning Commission which did set June 8, 2020, as the date a public hearing would be held on such application and proposed amendment; and

WHEREAS, notice of the time and date of the public hearing was given by publication on May 20, 2020, in *The Greene County Commonwealth*, a newspaper of general circulation in the City, such notice being at least 15 days before the date set for the public hearing; and

WHEREAS, the City gave notice of such public hearing to the record owners of all properties within the area proposed to be rezoned and within 185 feet of the property proposed to be rezoned; and

WHEREAS, a public hearing was conducted by the Planning and Zoning Commission on June 8, 2020, after which the Commission rendered written findings of fact on the proposed amendment and rezoning and, thereafter, submitted the same, together with its recommendations, to the City Council; and

WHEREAS, the Planning and Zoning Commission by a vote of 4 Ayes to 1 Nays, recommended the approval of such application for rezoning; and

WHEREAS, the application for rezoning and to amend the Zoning Code and Official Zoning Map was submitted to the City Council at its regular meeting on June 16, 2020, after which the City Council did proceed to vote to rezone such property and amend the Zoning Code accordingly.

NOW, THEREFORE, BE IT ORDAINED BY THE CITY COUNCIL OF THE CITY OF REPUBLIC, MISSOURI, AS FOLLOWS:

- Section 1. That the Zoning Code and Official Zoning Map are hereby amended insofar as the same relates to a certain tract of realty located at 127 East Mill and comprising approximately 0.47 acres from Medium Density Single-Family

BILL NO. 20-25

ORDINANCE NO. 20-

Residential (R1-M) to Two-Family Residential (R-2), such tract being more fully described as follows:

All of the East Half (E1/2) of Lot Two (2), SPARKMAN'S SECOND ADDITION, to the City of Republic, GREENE County, Missouri, according the recorded plat thereof.

Section 2. In all other aspects other than those herein amended, modified, or changed, the Zoning Code and Official Zoning Map shall remain the same and continue in full force and effect.

Section 3. The whereas clauses are hereby specifically incorporated herein by reference.

Section 4. This Ordinance shall take effect and be in force from and after its passage as provided by law.

PASSED AND APPROVED at a regular meeting of the City Council of the City of Republic, Missouri, this _____ day of _____ 2020.

Jeff Ussery, Mayor

Attest:

Laura Burbridge, City Clerk

Approved as to Form:  Digitally signed by Scott Ison
Date: 2020.06.09 11:00:40 -05'00', Scott Ison, City Attorney

Final Passage and Vote: _____

REZN 20-004: 127 East Mill Street

Item 5.

Future Land Use Map

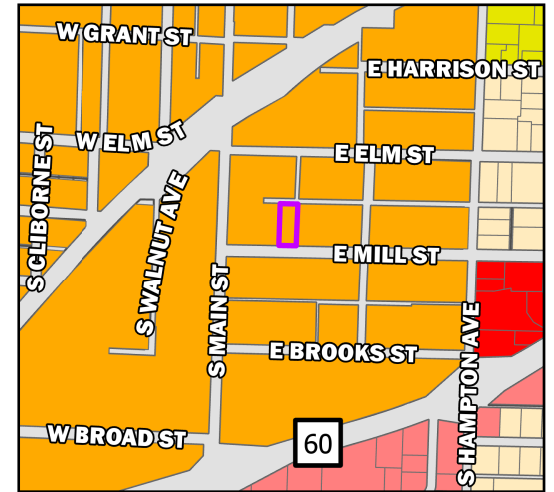

Legend

- Parcels
- REZN 20-004
- Low Density Residential
- High Density Residential
- Med Density Residential
- Main Street District
- C-1
- C-2
- M-1
- M-2
- Park
- Planned Business Park
- Public Land Use
- School Land Use

Parcel Owner: April Swanson
 Parcel Address: 127 E Mill St
 Area: 0.47 Acres
 Existing Zoning: Medium Density Single-Family (R1-M)
 Requested Zoning: Two-Family (R-2)
 Future Land Use Designation: Main Street District

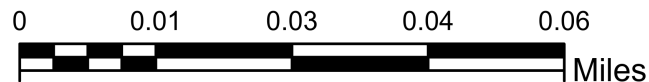

REZN 20-004: 127 East Mill Street

Item 5.

Vicinity Map

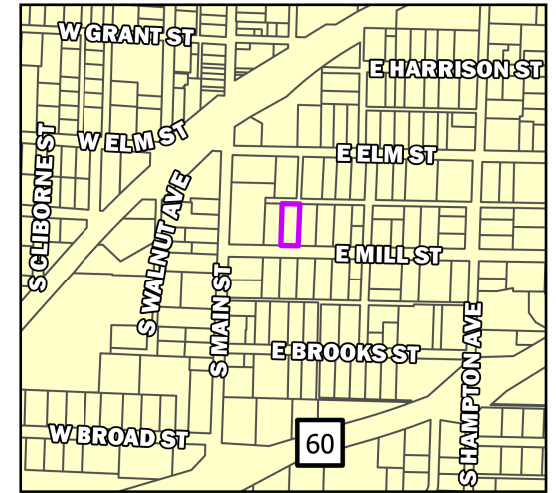
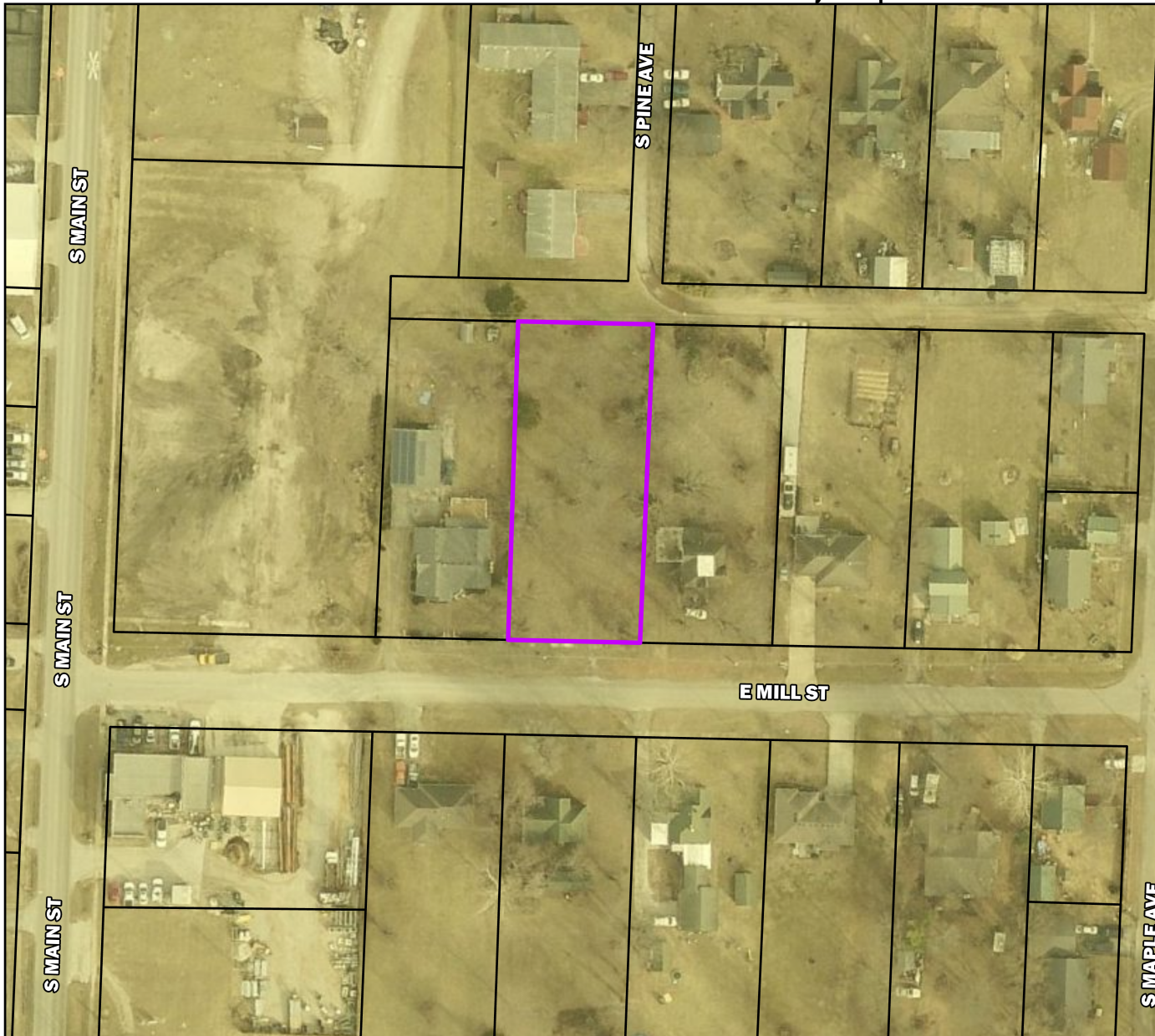

Legend

- Parcels
- City Limit
- REZN 20-004

Parcel Owner: April Swanson
Parcel Address: 127 E Mill St
Area: 0.47 Acres
Existing Zoning: Medium Density Single-Family (R1-M)
Requested Zoning: Two-Family (R-2)
Future Land Use Designation: Main Street District

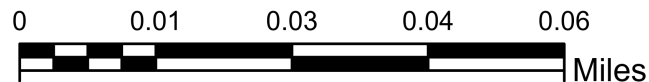

REZN 20-004: 127 East Mill Street

Item 5.

Zoning Map

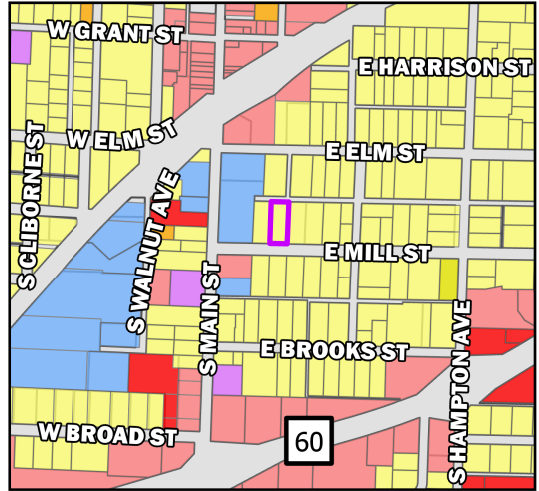

Legend

- Parcels
- REZN 20-004
- AG Agricultural
- C-1 Commercial
- C-2 General Commercial
- C-3 General Commercial
- M-1 Light Manufacturing
- M-2 Heavy Manufacturing
- PDD Planned Development
- R1-L Single Family Low Density
- R1-M Single Family Medium Density
- R1-H Single Family High Density
- R1-Z Zero Lot Line Residential
- R-2 Two-family Residential
- R-3 Multi-family Residential

Parcel Owner: April Swanson
 Parcel Address: 127 E Mill St
 Area: 0.47 Acres
 Existing Zoning: Medium Density Single-Family (R1-M)
 Requested Zoning: Two-Family (R-2)
 Future Land Use Designation: Main Street District

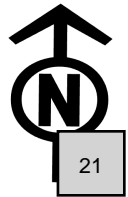
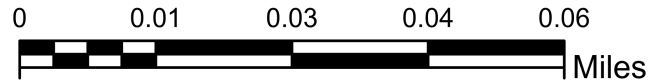

Section 405.130. "R-2" Two-Family Residential District Regulations. [CC 1999 §§26-104 — 26-108; Ord. No. 03-56 §1, 8-25-2003; Ord. No. 04-64 §1, 10-11-2004]

- A. *Purposes.* The intent of the "R-2" Two-Family Residential District is to permit and establish regulations for two-family residential dwellings at a density of approximately 6.7 units per acre. Internal stability, harmony, attractiveness, order and efficiency are encouraged by providing for adequate light, air and open space for dwellings and related facilities and by consideration of the proper functional relationship and arrangement of the different uses permitted in this district. This district is intended for areas that have access for vehicular traffic from collector or higher classification streets without crossing minor streets in adjoining neighborhoods.
- B. *Uses Permitted.*
1. Model homes in accordance with Section 410.190.
 2. Single-family dwellings, the use of which shall comply with the area requirements of the "R1-H" High Density Single-Family Residential District regulations.
 3. Zero lot line dwellings, the use of which shall comply with the area regulations of the "R1-Z" district regulations.
 4. Two (2) family dwelling.
 5. *Accessory buildings and structures.* As required by Section 405.640 of this Chapter.
 6. *Group homes.* The exterior appearance of the home and property shall be in reasonable conformance with the general neighborhood standards. No group home shall be located within two thousand five hundred (2,500) feet of another group home.
- C. *General Regulations.* Property and buildings in the "R-2" District shall be subject to the following regulations:
1. *Street frontage.* Each lot shall have a clear, direct frontage on a dedicated City street.
 2. *Platting requirements.* Each two-family dwelling shall be located on its own individual platted lot. If areas for common use of occupants of the development are shown on the plat, satisfactory arrangements shall be made for the maintenance

Section
405.130

Section
405.130

of the common open space and facilities, whether in the form of a neighborhood association or public dedication.

3. *Off-street parking.* As required by Article VI of this Chapter.
 4. *Accessory buildings and structures.* As required by Section 405.640 of this Chapter.
 5. *Trees.* There shall be a requirement of one (1) tree for each dwelling unit in order to enhance private space. The trees shall be of a variety that provides shade and screening and shall be at least six (6) feet in height at the time of planting.
- D. *Height And Area Regulations.* The height and area regulations set forth in Article V shall be observed.

TO THE CITY COUNCIL OF THE CITY OF REPUBLIC, MISSOURI:

Please take notice that the undersigned property owner(s) acknowledge that they are the owner(s) of either of the areas of the land (exclusive of streets and alleys) included in such proposed change or within an area determined by lines drawn parallel to and one hundred and eighty-five feet distant from the boundaries of the district proposed to be changed and that said owner(s) do protest and object to said proposed rezoning of Planning and Zoning Commission Case No. REZN 20-004, City Council Bill No., _____ (if applicable). This protest is given in contemplation of the provisions of City Code and applicable laws. Petitions must be filed with the City Clerk's Office located at 213 N Main St., Republic, Missouri, 65738, prior to the City Council's vote on the rezoning.

Printed Name of Owner:	Owner(s) Address:	Property Address (if different):	Owner(s) Signature(s)
Donna M. Uhrig	134 E. Elm Republic MO		Donna M. Uhrig
E. Dwayne Uhrig	134 E. Elm Republic MO		E. Dwayne Uhrig

PLEASE NOTE:

1. All owners of record must sign the petition exactly as shown on the deed in order for their property to be included in the required thirty percent.
2. Each property owner must sign his or her name personally. Spouses cannot sign for each other.
3. A Notary Public must witness each signature.

THE NOTARY EXECUTING THIS PETITION MUST WITNESS ALL SIGNATURES

STATE OF MISSOURI)
) ss.
COUNTY OF GREENE)



On this 4th day of June, 2020, before me personally appeared the above named person(s), to me known to be the person or persons described in and who executed the foregoing instrument and acknowledged that she/she/they executed the same as their free act and deed.

IN TESTIMONY WHEREOF, I have hereunto set my hand and affixed my official seal on the day and year first above written.

Signature of Notary Public [Handwritten Signature] (Seal)
My Commission Expires:

City of Republic
Rezoning Protest Petitions General Information

Pursuant to 89.060 RSMo., and Republic Municipal Code Section 405.980(A)(1), Such regulations, restrictions, and boundaries may from time to time be amended, supplemented, changed, modified or repealed. In case, however, of a protest against such change duly signed and acknowledged by the owners of thirty percent or more, either of the areas of the land (exclusive of streets and alleys) included in such proposed change or within an area determined by lines drawn parallel to and one hundred and eighty-five feet distant from the boundaries of the district proposed to be changed, such amendment shall not become effective except by the favorable vote of two-thirds of all the members of the legislative body of such municipality. The provisions of section 89.050 relative to public hearing and official notice shall apply equally to all changes or amendments.

Anyone may attend the public hearing to be held by the Planning and Zoning Commission or at the first reading of the rezoning ordinance by the City Council to hear information, ask questions, and to speak for or against the rezone. These public meetings are published as to the time and place by the City Clerk in electronic format and at City Hall located at 213 N Main St., Republic, Missouri, 65738. In addition, you can contact the City Clerk at 417-732-3140.

All rezoning protest petitions must be received by the City Clerk, prior to the City Council's vote on the rezoning. The rezoning protest petitions must be sent to or hand delivered to:

City of Republic
ATTN: City Clerk
213 N Main Street
Republic, MO 65738

If you have any questions about this process, please call either the City Clerk's Office at 417-732-3140 or the Community Development at 417-732-3150.

TO THE CITY COUNCIL OF THE CITY OF REPUBLIC, MISSOURI:

Please take notice that the undersigned property owner(s) acknowledge that they are the owner(s) of either of the areas of the land (exclusive of streets and alleys) included in such proposed change or within an area determined by lines drawn parallel to and one hundred and eighty-five feet distant from the boundaries of the district proposed to be changed and that said owner(s) do protest and object to said proposed rezoning of Planning and Zoning Commission Case No. REZN 20-004, City Council Bill No., _____ (if applicable). This protest is given in contemplation of the provisions of City Code and applicable laws. Petitions must be filed with the City Clerk's Office located at 213 N Main St., Republic, Missouri, 65738, prior to the City Council's vote on the rezoning.

Printed Name of Owner:	Owner(s) Address:	Property Address (if different):	Owner(s) Signature(s)
Randy Taylor	2004 S. 15 th St Ozark	133 E. Mill St. Republic	Randy Taylor
Tammy Taylor	2004 S. 15 th St Ozark	133 E. Mill St. Republic	Tammy Taylor

PLEASE NOTE:

1. All owners of record must sign the petition exactly as shown on the deed in order for their property to be included in the required thirty percent.
2. Each property owner must sign his or her name personally. Spouses cannot sign for each other.
3. A Notary Public must witness each signature.

THE NOTARY EXECUTING THIS PETITION MUST WITNESS ALL SIGNATURES

STATE OF MISSOURI)
) ss.
COUNTY OF GREENE)

On this 4th day of June, 2020, before me personally appeared the above named person(s), to me known to be the person or persons described in and who executed the foregoing instrument and acknowledged that she/she/they executed the same as their free act and deed.

IN TESTIMONY WHEREOF, I have hereunto set my hand and affixed my official seal on the day and year first above written.

Signature of Notary Public *Shanelle J Leigh*

My Commission Expires:
July 23, 2023

(Seal)



**City of Republic
Rezoning Protest Petitions General Information**

Pursuant to 89.060 RSMo., and Republic Municipal Code Section 405.980(A)(1), Such regulations, restrictions, and boundaries may from time to time be amended, supplemented, changed, modified or repealed. In case, however, of a protest against such change duly signed and acknowledged by the owners of thirty percent or more, either of the areas of the land (exclusive of streets and alleys) included in such proposed change or within an area determined by lines drawn parallel to and one hundred and eighty-five feet distant from the boundaries of the district proposed to be changed, such amendment shall not become effective except by the favorable vote of two-thirds of all the members of the legislative body of such municipality. The provisions of section 89.050 relative to public hearing and official notice shall apply equally to all changes or amendments.

Anyone may attend the public hearing to be held by the Planning and Zoning Commission or at the first reading of the rezoning ordinance by the City Council to hear information, ask questions, and to speak for or against the rezone. These public meetings are published as to the time and place by the City Clerk in electronic format and at City Hall located at 213 N Main St., Republic, Missouri, 65738. In addition, you can contact the City Clerk at 417-732-3140.

All rezoning protest petitions must be received by the City Clerk, prior to the City Council's vote on the rezoning. The rezoning protest petitions must be sent to or hand delivered to:

City of Republic
ATTN: City Clerk
213 N Main Street
Republic, MO 65738

If you have any questions about this process, please call either the City Clerk's Office at 417-732-3140 or the Community Development at 417-732-3150.

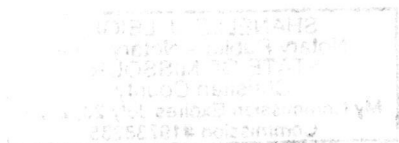

REZN 20-004 127 E Mill St

Buffer Map and List of Registered Letters Sent

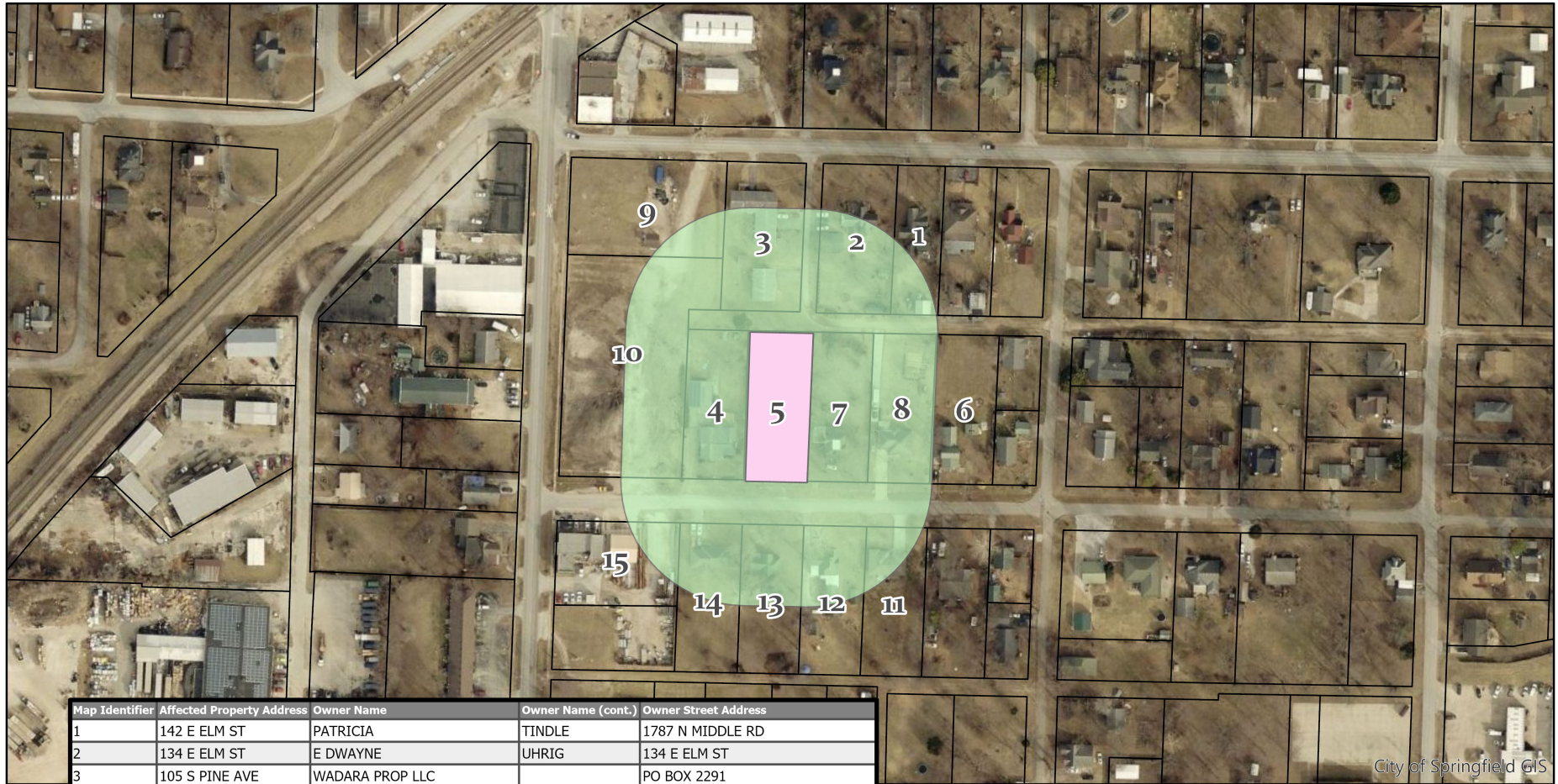

City of Springfield GIS

Map Identifier	Affected Property Address	Owner Name	Owner Name (cont.)	Owner Street Address
1	142 E ELM ST	PATRICIA	TINDLE	1787 N MIDDLE RD
2	134 E ELM ST	E DWAYNE	UHRIG	134 E ELM ST
3	105 S PINE AVE	WADARA PROP LLC		PO BOX 2291
4	119 E MILL ST	JOHN M	TAYLOR	119 E MILL ST
5	127 E MILL ST	APRIL RENEE	SWANSON	2611 E KENTWOOD ST
6	147 E MILL ST	JONATHAN J	CONN, ETAL	147 E MILL ST
7	133 E MILL ST	RANDY	TAYLOR	133 E MILL ST
8	135 E MILL ST	KEVIN L	CORNER	PO BOX 35
9	E ELM ST	MICHAEL	CLEVELAND	7222 N FARM ROAD 203
10	101 E MILL ST	MICHAEL	CLEVELAND	7222 N FARM ROAD 203
11	136 E MILL ST	KEVIN L	CORNER	PO BOX 35
12	132 E MILL ST	GARY E	BLADES	510 N WALNUT AVE
13	124 E MILL ST	DAVID K	MYERS	533 N KYLE AVE
14	116 E MILL ST	VL PROPERTIES LLC		480 US HIGHWAY 60 E
15	202 S MAIN ST	EMPIRE DISTRICT ELECTRIC CO		PO BOX 127, ATTN: TAX SPECIALIST

Legend

- REZN 20-004 (127 E Mill St)
- 185 Ft Buffer
- Parcels

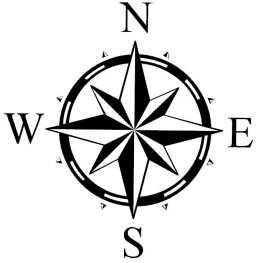



AGENDA ITEM ANALYSIS

Project/Issue Name: 20-26 An Ordinance of the City Council of the City of Republic, Missouri, Approving Amending the Zoning Code and Official Map by Changing the Classification of Approximately 0.47 Acres, Located at 616 North Phelps Avenue, from Medium Density Single-Family Residential (R1-M) to High Density Single-Family Residential (R1-H).

Submitted By: Community Development Department

Date: June 16, 2020

Issue Statement

White Oak Holding, LLC has applied to change the Zoning Classification of **(0.47) acres** of property located at 616 North Phelps from **Medium Density Single-Family Residential (R1-M) to High Density Single-Family Residential (R1-H)**.

Discussion and/or Analysis

The property subject to this Rezoning Application is comprised of approximately (0.47) acres of land located at 616 North Phelps Avenue. The property currently contains a single-family residential structure in uninhabitable condition. The Applicant has expressed interest in demolishing the existing structure, subdividing the parcel into two (2) parcels, and building two (2) new single-family residential dwellings.

The following paragraphs contain brief analyses of present site conditions as well as the proposal's relationship to **adopted plans of the City.**

Consistency with the Comprehensive Plan

The City's Comprehensive Plan generally encourages the expansion of residential development through proactive rezoning of land at appropriate locations. Appropriate locations are described generally throughout the Plan, with regard to the **relationship of land at particular locations to infrastructure capable of supporting various intensities and densities of uses.**

The Plan also more particularly describes appropriate future land uses through the depiction of a **"Future Land Use Map" (FLUM)**. In this case, the FLUM depicts the subject property as having a **Medium Density Residential** designation. The City's Adopted 2005 Land Use Plan has identified the

Medium Residential” Future Land Use Map designation as an area of two-family residential development at 4-7 units per acre and neighborhood compatible institutional uses.

The 2005 Land Use Plan identifies Land Use Goals and Objectives relating to residential development, as follows:

- Goal: Cost-effective Private Development Density. Encourage higher density development that will reduce the amount of infrastructure and cost to the developer and reduce the maintenance costs by the City.
 - Objective: Use the Land Use Plan to promote and guide the development of land at higher densities to reduce the amount of infrastructure constructed within the City.
 - Policies:
 - Plan for higher density development that will reduce the cost of maintenance of new infrastructure improvements, such as water, sanitary sewer, stormwater and roads.
- Goal: Encourage the development of Infill Housing
 - Objective: Promote infill housing development
 - Policies:
 - Promote infill development as a means of maximizing existing infrastructure and encouraging reinvestment in existing neighborhoods
- Goal: Diversify the Republic Housing Market.
 - Objective: Promote all types of residential development.
- Goal: Improve the quality of all types of housing in the City.
 - Objective: Encourage the development of high-quality housing regardless of the size, type, and density of housing being constructed.

The 2005 Land Use Plan identifies “Neighborhood Principles and Development Guidelines,” which “provide guidance for how a mixture of land uses can work together to create community.”

- Principle: Republic should be a full-service community for a diverse population consisting of neighborhoods designed for human interaction.
 - Guideline: A range of housing types and sizes to accommodate household of all ages and sizes should be provided in each Republic neighborhood. A mix of housing types within a neighborhood creates visual and economic variety as well as opportunities for a more diverse population.

The general trend of development in the vicinity of the subject property, along North Phelps Avenue and surrounding streets is of well-established single-family dwelling neighborhoods.



Compatibility with Surrounding Land Uses

The subject property is surrounded by Medium Density Single-Family Residential (R1-M) Zoning to the north, south, east, and appear to be utilized as single-family residences.

The land uses permitted in the High Density Single-Family Residential (R1-H) Zoning District include single-family dwellings, residential accessory structures, golf courses, and schools.

Capacity To Serve Potential Development and Land Use

Municipal Water and Sewer Service: The parcel currently contains an uninhabitable single-family home served by City of Republic water and sanitary sewer service.

The site is served by a four (4) inch water main and eight (8) inch sanitary sewer main located along North Phelps Avenue. The sanitary sewer flows directly to the Wastewater Treatment Facility. The City's water system and Wastewater Treatment Facility currently have capacity to serve potentially two (2) new residential single-family dwellings at this location.

Transportation: A Traffic Impact Study (TIS) was not required for the Rezoning Application due to no increase in traffic volumes for a single parcel to transition from Medium Density to High Density Single Family Residential Zoning; a potential Minor Subdivision dividing the parcel into two (2) High Density Single-Family parcels will not increase traffic volumes to warrant a TIS.

Floodplain: The subject parcel **does not** contain a Special Flood Hazard Area (SFHA/Floodplain).

Sinkholes: The subject parcel **does not** contain any identified sinkholes.

Extent to which Proposed Amendment Creates Nonconformities

Any existing single-family residential uses presently conducted on the subject property would be permitted to continue as is at the time of rezone until such time as the use is altered in a way that would remove that lawfully existing nonconforming status. Types of alterations that would cause the removal of that status include redevelopment, expansion of the nonconforming use, substantial destruction of the nonconformity, etc.

Recommended Action

Staff considers the **proposed Zoning Map Amendment (Rezoning)** to be generally consistent with the **goals and objectives of the Comprehensive Plan**, consistent with the **trend of residential development in the vicinity of the site**, **compatible with surrounding land uses**, and **able to be adequately served by municipal facilities**. Based upon this analysis (performed without the benefit of evidence and testimony of a public hearing), **Staff recommends the approval of this application.**

AN ORDINANCE OF THE CITY COUNCIL OF THE CITY OF REPUBLIC, MISSOURI, APPROVING AMENDING THE ZONING CODE AND OFFICIAL MAP BY CHANGING THE CLASSIFICATION OF APPROXIMATELY 0.47 ACRES, LOCATED AT 616 NORTH PHELPS AVENUE, FROM MEDIUM DENSITY SINGLE-FAMILY RESIDENTIAL (R1-M) TO HIGH DENSITY SINGLE-FAMILY RESIDENTIAL (R1-H)

WHEREAS, the City of Republic, Missouri, (herein called the “City” or “Republic”) is a municipal corporation and Charter City located in Greene County, Missouri, being duly created, organized, and existing under the laws of the State of Missouri; and

WHEREAS, an application for amendment to the Zoning Code and Official Zoning Map to rezone real estate located at 616 North Phelps Avenue and comprising approximately 0.47 acres from Medium Density Single-Family Residential (R1-M) to High Density Single-Family Residential (R1-H), was submitted to the Community Development Department Staff by White Oak Holding, LLC (hereinafter “Applicant”); and

WHEREAS, the Community Development Staff did thereafter submit said application to the Planning and Zoning Commission which did set June 8, 2020, as the date a public hearing would be held on such application and proposed amendment; and

WHEREAS, notice of the time and date of the public hearing was given by publication on May 20, 2020, in *The Greene County Commonwealth*, a newspaper of general circulation in the City, such notice being at least 15 days before the date set for the public hearing; and

WHEREAS, the City gave notice of such public hearing to the record owners of all properties within the area proposed to be rezoned and within 185 feet of the property proposed to be rezoned; and

WHEREAS, a public hearing was conducted by the Planning and Zoning Commission on June 8, 2020, after which the Commission rendered written findings of fact on the proposed amendment and rezoning and, thereafter, submitted the same, together with its recommendations, to the City Council; and

WHEREAS, the Planning and Zoning Commission by a vote of 5 Ayes to 0 Nays, recommended the approval of such application for rezoning; and

WHEREAS, the application for rezoning and to amend the Zoning Code and Official Zoning Map was submitted to the City Council at its regular meeting on June 16, 2020, after which the City Council did proceed to vote to rezone such property and amend the Zoning Code accordingly.

NOW, THEREFORE, BE IT ORDAINED BY THE CITY COUNCIL OF THE CITY OF REPUBLIC, MISSOURI, AS FOLLOWS:

- Section 1. That the Zoning Code and Official Zoning Map are hereby amended insofar as the same relates to a certain tract of realty located at 616 North Phelps Avenue and comprising approximately 0.47 acres from Medium Density

BILL NO. 20-26

ORDINANCE NO. 20-

Single-Family Residential (R1-M) to High Density Single-Family Residential (R1-H), such tract being more fully described as follows:

All of Lot Twenty Four (24) and the South Fifty Three (53) feet of lot Twenty Five (25) in the G.W. HINES SECOND ADDITION, a Subdivision the Town of Republic, Greene County, MO, according to the recorded plat thereof.

Section 2. In all other aspects other than those herein amended, modified, or changed, the Zoning Code and Official Zoning Map shall remain the same and continue in full force and effect.

Section 3. The whereas clauses are hereby specifically incorporated herein by reference.

Section 4. This Ordinance shall take effect and be in force from and after its passage as provided by law.

PASSED AND APPROVED at a regular meeting of the City Council of the City of Republic, Missouri, this _____ day of _____ 2020.

Jeff Ussery, Mayor

Attest:

Laura Burbridge, City Clerk

Approved as to Form:  Digitally signed by Scott Ison
Date: 2020.06.09 10:56:57 -05'00', Scott Ison, City Attorney

Final Passage and Vote: _____

REZN 20-005: 616 North Phelps Avenue

Item 6.

Vicinity Map

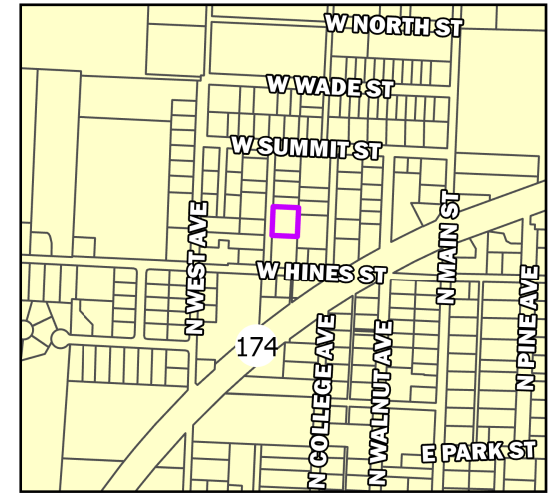
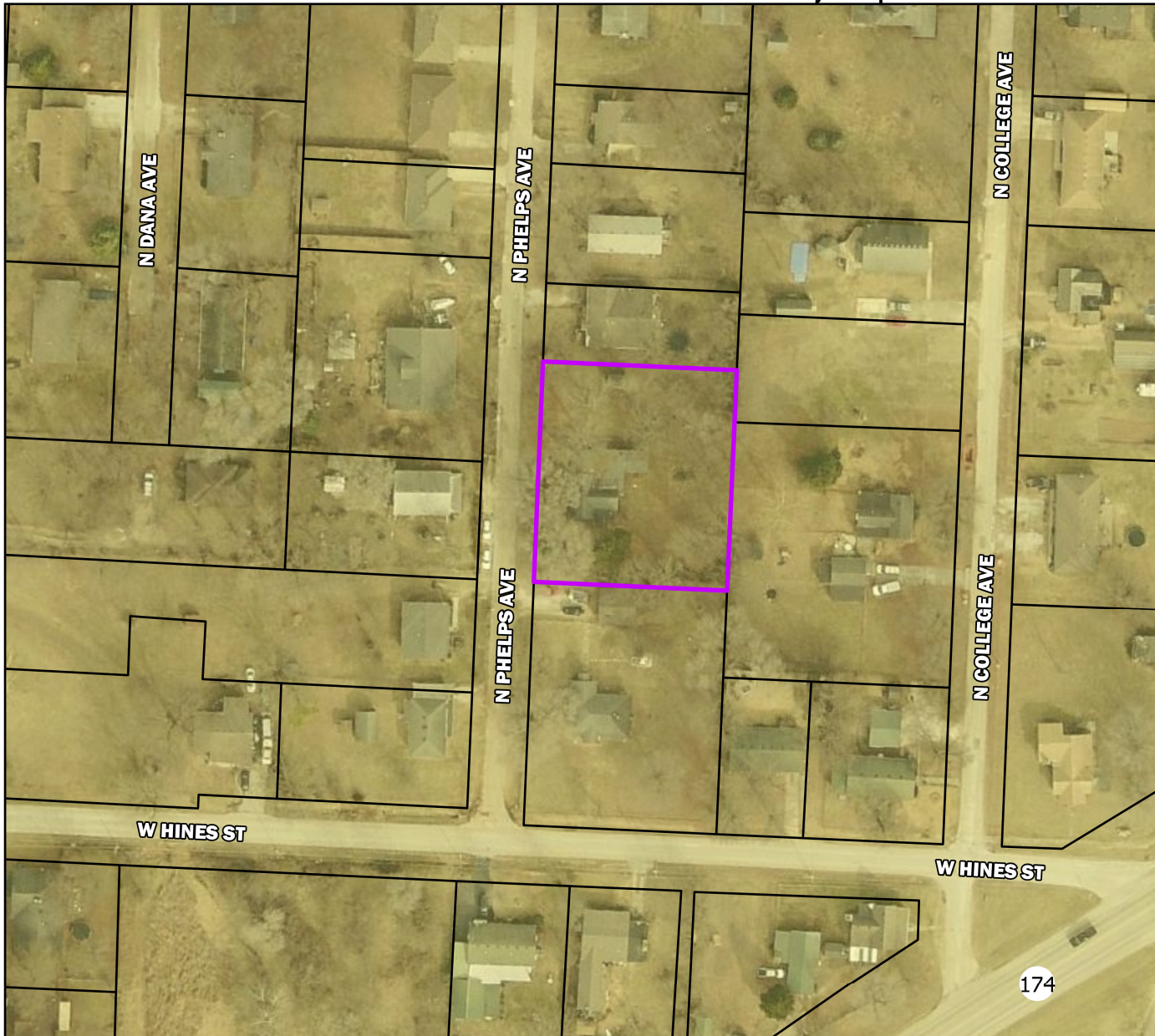

Legend

-  REZN 20-005
-  Parcels
-  City Limits

Parcel Owner: White Oak Holding LLC
Parcel Address: 616 N Phelps Ave
Area: 0.47 Acres
Existing Zoning: Medium Density Single-Family (R1-M)
Requested Zoning: High Density Single-Family (R1-H)
Future Land Use Designation: Medium Density Residential

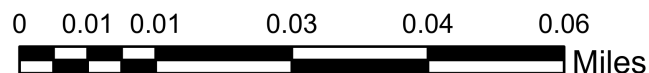

REZN 20-005: 616 North Phelps Avenue

Item 6.

Future Land Use Map

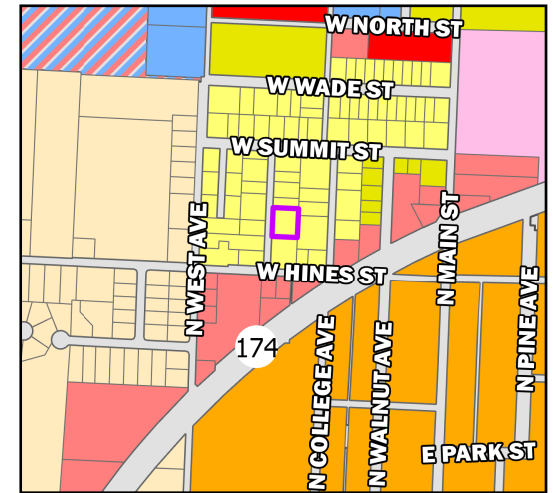
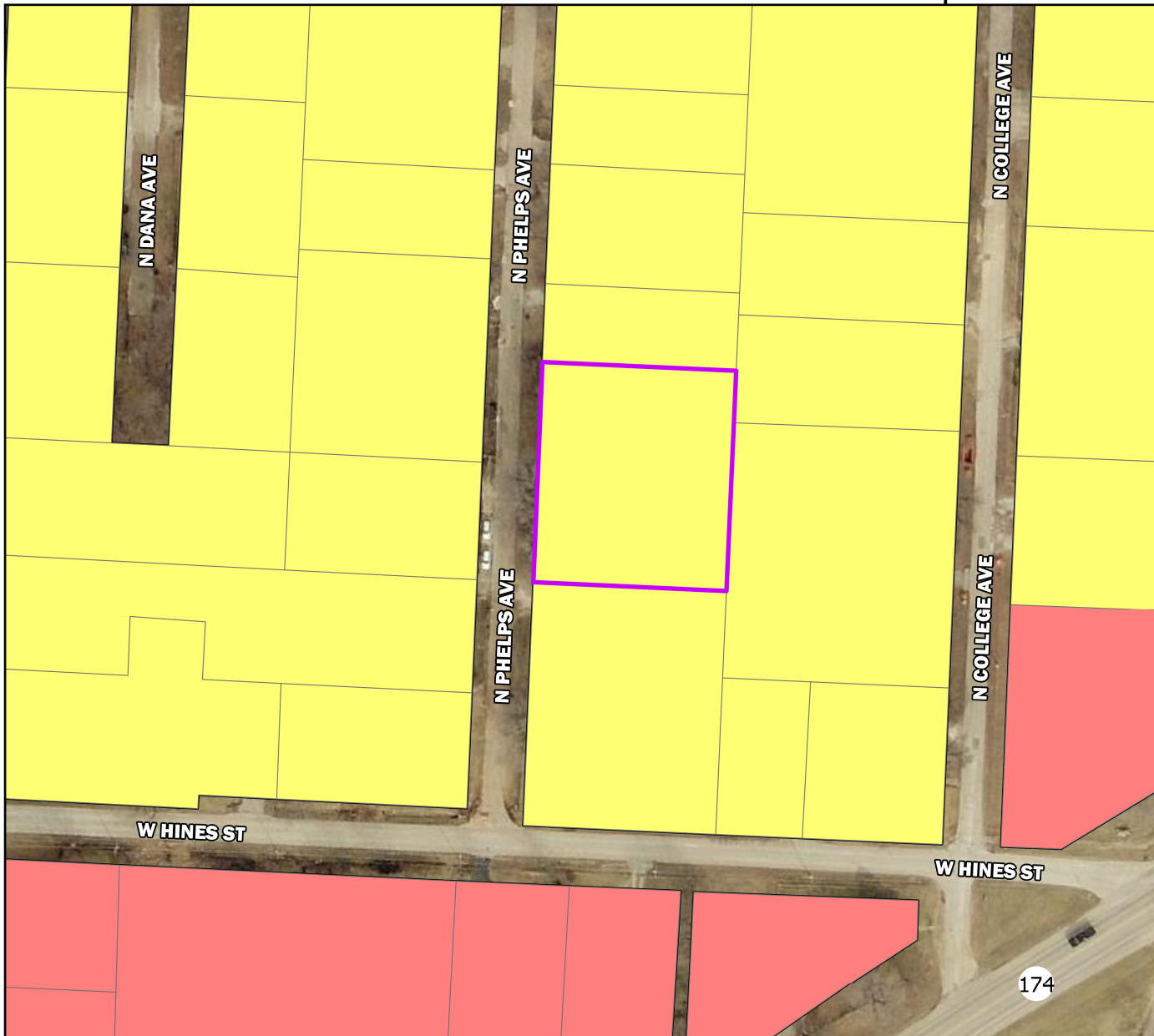

Legend

- REZN 20-005
- Parcels
- Low Density Residential
- High Density Residential
- Med Density Residential
- Main Street District
- C-1
- C-2
- M-1
- M-2
- Park
- Planned Business Park
- Public Land Use
- School Land Use

Parcel Owner: White Oak Holding LLC
 Parcel Address: 616 N Phelps Ave
 Area: 0.47 Acres
 Existing Zoning: Medium Density Single-Family (R1-M)
 Requested Zoning: Two-Family (R-2)
 Future Land Use Designation: Medium Density Residential

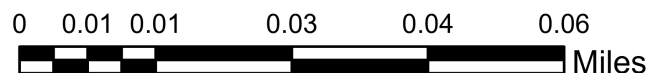

REZN 20-005: 616 North Phelps Avenue

Item 6.

Zoning Map

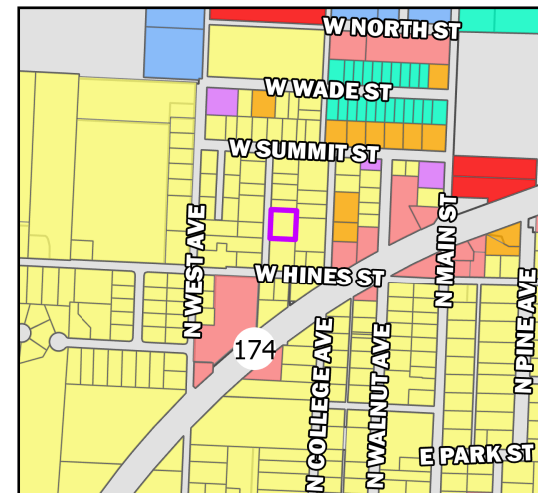
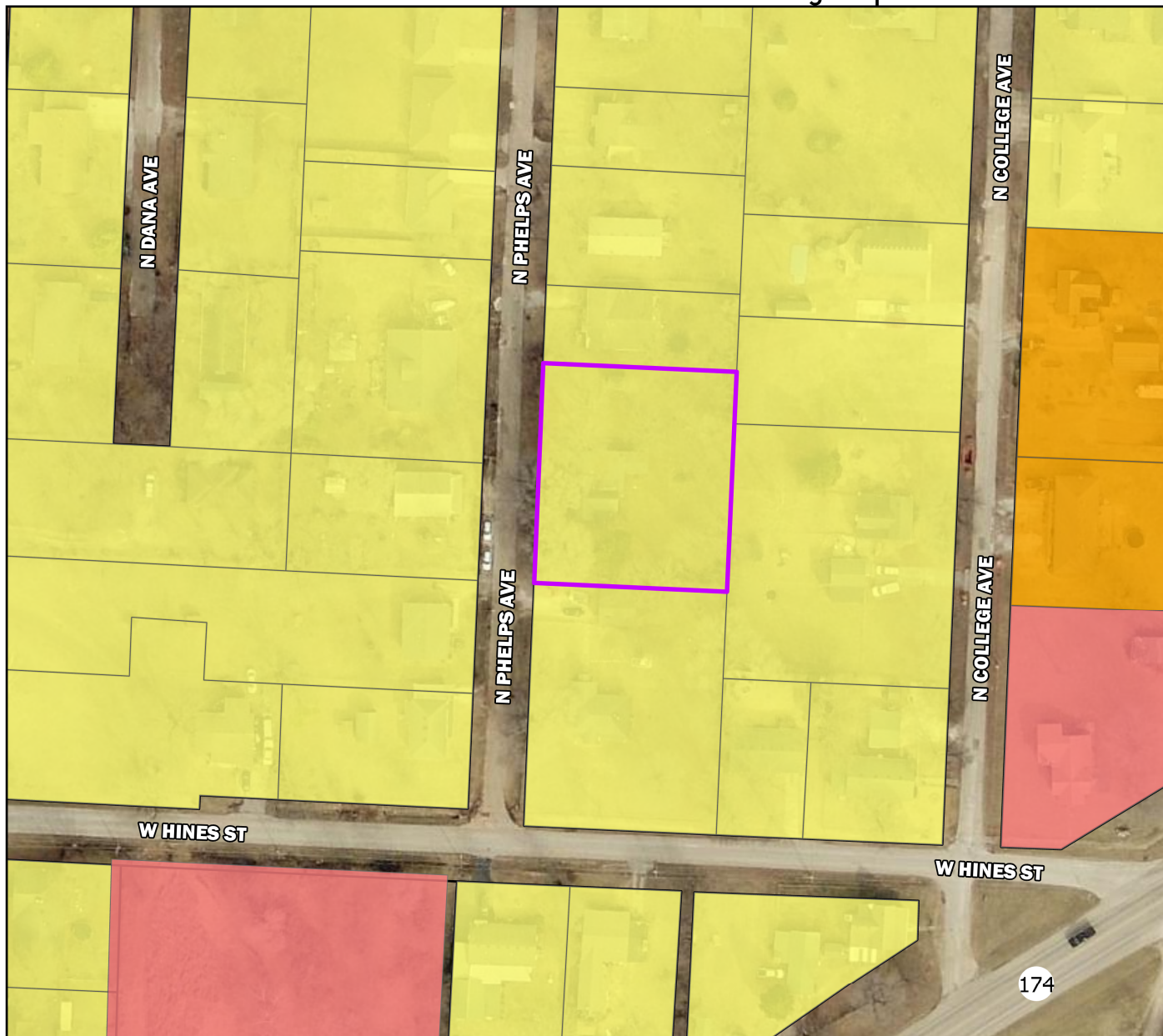

Legend

- REZN 20-005
- Parcels
- AG Agricultural
- C-1 Commercial
- C-2 General Commercial
- C-3 General Commercial
- M-1 Light Manufacturing
- M-2 Heavy Manufacturing
- PDD Planned Development
- R1-L Single Family Low Density
- R1-M Single Family Medium Density
- R1-H Single Family High Density
- R1-Z Zero Lot Line Residential
- R-2 Two-family Residential
- R-3 Multi-family Residential

Parcel Owner: White Oak Holding LLC
 Parcel Address: 616 N Phelps Ave
 Area: 0.47 Acres
 Existing Zoning: Medium Density Single-Family (R1-M)
 Requested Zoning: Two-Family (R-2)
 Future Land Use Designation: Medium Density Residential

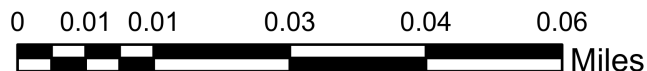

Section 405.100. "R1-H" High Density Single-Family Residential District. [CC 1999 §26-18]

- A. *Purposes.* The intent of the "R1-H" High Density Single-Family Residential District is designed for seven thousand (7,000) square foot single-family detached residential uses at higher densities of approximately six (6) dwelling units per acre. Internal stability, harmony, attractiveness, order and efficiency are encouraged by providing for adequate light, air and open space for dwellings and related facilities and by consideration of the proper functional relationship and arrangement of the different uses permitted in this district. This district is intended for areas that have access for vehicular traffic from collector or higher classification streets without crossing minor streets in adjoining neighborhoods.
- B. *Uses Permitted.*
1. Model homes in accordance with Section 410.190.
 2. Single-family dwellings.
 3. Accessory buildings customary, incidental and subordinate to the main building.
 4. Churches or other places of worship, including parish houses and Sunday Schools, but excluding overnight shelters and temporary outdoor revivals, on a minimum of two (2) acres of land, to provide sufficient land area for off-street parking, bufferyards and proper site design to lessen impact on adjoining residential neighborhoods. The requirements of Article VI and X regarding parking, loading, landscaping, and open space shall be required.
 5. Home occupations in accordance with Section 405.630.
 6. Public school, elementary and high, and educational institutions having a curriculum the same as ordinarily given in public schools, on a minimum of two (2) acres of land, to provide sufficient land area for off-street parking, bufferyards and proper site design to lessen impact on adjoining residential neighborhoods. The requirements of Article VI and X regarding parking, loading, landscaping, and open space shall be required.
 7. Golf courses and country clubs.
 8. Any use conforming at the time the district is mapped.

Section
405.100

Section
405.100

- 9. *Group homes.* The exterior appearance of the home and property shall be in reasonable conformance with the general neighborhood standards. No group home shall be located within two thousand five hundred (2,500) feet of another group home.
- C. *General Regulations.* Property and buildings in the "R1-H" District shall be subject to the following regulations:
- 1. *Street frontage.* Each lot shall have a clear, direct frontage on a dedicated City street.
 - 2. *Platting requirements.* Each dwelling shall be located on its own individual platted lot. If areas for common use of occupants of the development are shown on the plat, satisfactory arrangements shall be made for the maintenance of the common open space and facilities, whether in the form of a neighborhood association or public dedication. The plat shall indicate the easements and covenants appurtenant thereto.
 - 3. *Off-street parking.* As required by Article VI of this Chapter.
 - 4. *Accessory buildings and structures.* As required by Section 405.640 of this Chapter.
 - 5. *Trees.* There shall be a requirement of at least one (1) tree for each platted lot in order to enhance private space. The tree shall be of a variety that provides shade and screening and shall be at least six (6) feet in height at the time of planting.
- D. *Height And Area Regulations.* The height and area regulations shall be provided in accordance with the requirements set forth in Article V.



AGENDA ITEM ANALYSIS

Project/Issue Name: 20-27 An Ordinance of the City Council of the City of Republic, Missouri, to Establish a Procedure for Disclosing Potential Conflicts of Interest and Substantial Interests for Certain Officials.

Submitted By: Scott Ison, City Attorney

Date: July 21, 2020

Issue Statement

To re-adopt the procedures for disclosing potential conflicts of interest and substantial interests for certain officials as required by the Missouri Ethics Commission.

Discussion and/or Analysis

In 2018, the City re-adopted the procedures for disclosing potential conflicts of interest and substantial interests for certain officials. If the city's annual budget is over one million dollars, the City is required to re-adopt a conflict of interest ordinance every two (2) years before the September 15, 2020 deadline established by the Missouri Ethics Commission. Once approved, the ordinance must be forwarded to the Missouri Ethics Commission within ten (10) days of passage in order for it to go into effect. All elected, appointed and decision-making personnel and candidates would be required to file a Financial Interest Statement for Political Subdivisions if any transactions occurred in the previous calendar year that would be considered a conflict of interest as per this ordinance and State Statute. If this ordinance is not re-adopted, all elected, appointed, and decision-making personnel, and candidates would be required to file a Personal Financial Disclosure Statement (long form).

Recommended Action

Staff recommends approval.

AN ORDINANCE OF THE CITY COUNCIL OF THE CITY OF REPUBLIC, MISSOURI, TO ESTABLISH A PROCEDURE FOR DISCLOSING POTENTIAL CONFLICTS OF INTEREST AND SUBSTANTIAL INTERESTS FOR CERTAIN OFFICIALS

WHEREAS, the City of Republic, Missouri, (herein called the “City” or “Republic”) is a municipal corporation and Charter City located in Greene County, Missouri, being duly created, organized, and existing under the laws of the State of Missouri; and

WHEREAS, if the City’s annual budget is over one million dollars, the City is required to re-adopt a conflict of interest ordinance every two (2) years prior to the Missouri Ethics Commission deadline of September 15th; and

WHEREAS, the City last adopted a conflict of interest ordinance in Bill 18-32 on June 16, 2018; and

WHEREAS, after the ordinance is approved, the ordinance must be forwarded to the Missouri Ethics Commission within ten (10) days of passage in order for it to go into effect.

NOW, THEREFORE, BE IT ORDAINED BY THE CITY COUNCIL OF THE CITY OF REPUBLIC, MISSOURI, AS FOLLOWS:

Section 1. **Declaration of Policy:** The proper operation of government requires that public officials and employees be independent, impartial and responsible to the people; that government decisions and policy be made in the proper channels of the governmental structure; that public office not be used for personal gain; and that the public have confidence in the integrity of its government. In recognition of these goals, there is hereby established a procedure for disclosure by certain officials and employees of private financial or other interests in matters affecting the City.

Section 2. **Conflicts of Interest:**

- a. All elected and appointed officials, as well as employees of a political subdivision, must comply with Section 105.454 of Missouri Revised Statutes on conflicts of interest as well as any other state law governing official conduct.
- b. Any member of the governing body of a political subdivision who has a “substantial or private interest” in any measure, bill, order or ordinance proposed or pending before such governing body must disclose that interest to the secretary or clerk of such body and such disclosure shall be recorded in the appropriate journal of the governing body. Substantial or private interest is defined as ownership by the individual, his spouse, or his dependent children, whether singularly or collectively, directly or indirectly of: (1) ten percent (10%) or more of any business entity; or (2) an interest having a value of \$10,000.00 or more; or (3) the receipt of a salary, gratuity, or other compensation or remuneration of \$5,000.00 or

more, per year from any individual, partnership, organization, or association within any calendar year.

Section 3. **Disclosure Reports:** Each elected official, candidate for elective office, the chief administrative officer, the chief purchasing officer, and the full-time general counsel shall disclose the following information by May 1, or the appropriate deadline as referenced in Section 105.487 RSMo, if any such transactions occurred during the previous calendar year.

- a. For such person, and all persons within the first degree of consanguinity of affinity of such person, the date and the identities of the parties to each transaction with total value in excess of five hundred dollars, if any, that such person had with the political subdivision, other than compensation received as an employee or payment of any tax, fee or penalty due to the political subdivision, and other than transfers for no consideration to the political subdivision.
- b. The date and the identities of the parties to each transaction known to the person with a total value in excess of five hundred dollars, if any, that any business entity in which such person had a substantial interest, had with the political subdivision, other than payment of any tax, fee or penalty due to the political subdivision or transactions involving payment for providing utility service to the political subdivision, and other than transfers for no consideration to the political subdivision.
- c. The chief administrative officer, chief purchasing officer, and candidates for either of these positions also shall disclose by May 1, or the appropriate deadline as referenced in Section 105.487, RSMo., the following information for the previous calendar year:
 - i. The name and address of each of the employers of such person from whom income of one thousand dollars or more was received during the year covered by the statement;
 - ii. The name and address of each sole proprietorship that he owned; the name, address and the general nature of the business conducted of each general partnership and joint venture in which he was a partner or participant; the name and address of each partner or co-participant for each partnership or joint venture unless such names and addresses are filed by the partnership or joint venture with the Secretary of State; the name, address and general nature of the business conducted of any closely held corporation or limited partnership in which the person owned ten percent (10%) or more of any class of outstanding stock or limited partnership units; and the name of any publicly traded corporation or limited partnership that is listed on a regulated stock exchange or automated quotation

system in which the person owned two percent (2%) or more of any class or outstanding stock, limited partnership units or other equity interests;

- iii. The name and address of each corporation for which such person served in the capacity of a director, officer, or receiver.

Section 4. **Filing of Reports:**

- a. The financial interest statements shall be filed at the following times, but no person is required to file more than one financial interest statement in any calendar year;
 - i. Every person required to file a financial interest statement shall file the statement annually not later than May 1 and the statement shall cover the calendar year ending the immediately preceding December 31; provided that any member of the City Council may supplement the financial interest statement to report additional interests acquired after December 31 of the covered year until the date of filing of the financial interest statement.
 - ii. Each person appointed to office, shall file the statement within thirty (30) days of such appointment or employment covering the calendar year ending the previous December 31;
 - iii. Every candidate required to file a personal financial disclosure statement shall file no later than fourteen days after the close of filing at which the candidate seeks nomination or election or nomination by caucus. The time period of this statement shall cover the twelve months prior to the closing date of filing for candidacy.
- b. Financial disclosure reports giving the financial information required in Section 3 shall be filed with the local political subdivision and with the Missouri Ethics Commission. The reports shall be available for public inspection and copying during normal business hours.

Section 5. **Filing of Ordinance:** A certified copy of this ordinance, adopted prior to September 15th, shall be sent within ten (10) days of its adoption to the Missouri Ethics Commission.

Section 6. **Effective Date:** This ordinance shall be in full force and effect from and after the date of its passage and approval and shall remain in effect to the next filing period as required.

PASSED AND APPROVED at a regular meeting of the City Council of the City of Republic, Missouri, this _____ day of _____ 2020.

Jeff Ussery, Mayor

Attest:

Laura Burbridge, City Clerk

Approved as to Form:  Digitally signed by Scott Ison
Date: 2020.06.25 12:47:53 -05'00', Scott Ison, City Attorney

Final Passage and Vote: _____



AGENDA ITEM ANALYSIS

Project/Issue Name: 20-28 An Ordinance of the City Council of the City of Republic, Missouri, Approving the Annexation of Approximately 5.0 Acres of Land Located at 688 South Kansas Avenue and Adjacent Right-of-Way.

Submitted By: Karen Haynes, Community Development Department

Date: July 21, 2020

Issue Statement

The City of Republic's Community Development Department received a Voluntary Annexation Application from Cleo Smith for the Annexation of approximately five (5.0) acres of land located at 688 South Kansas Avenue.

Discussion and/or Analysis

The property owner, Cleo Smith, has submitted a Voluntary Annexation Request for the subject parcel for a future residential development.

The request includes annexation of the Right-of-Way (South Kansas Avenue) adjacent to the property subject to Annexation.

City water and sanitary sewer service is available in proximity to the property; subsequent review of water, sanitary sewer, and stormwater will be considered at the time of application for Rezoning and/or development. The subject parcel is compact and contiguous with the city limits of the City of Republic, as the subject parcel is surrounded by properties located in the City to the north, south, and east.

The Future Land Use designation of the subject parcel is Low-Density Residential. The Low Density Residential Future Land Use designation includes Single-Family Residential Development at 1-6 units per acre and neighborhood compatible institutional uses. Low Density Residential Land Uses include the following Zoning Districts: High Density Single-Family Residential (R1-H), Medium Density Single Family-Residential (R1-M), and Low Density Single-Family Residential (R1-L).

The Annexation, if approved by City Council, will effectively zone the subject parcel as AG (Agricultural) in accordance with City Code Section 435.010.B, which requires all annexed properties to be classified in the zoning district corresponding to Greene County's zoning designation.

Recommended Action

Staff believes the Annexation of the subject property is consistent with the City's Future Land Use Map and Comprehensive Plan as an area of future residential growth for the City of Republic and enjoys immediate access to City of Republic municipal services.

AN ORDINANCE OF THE CITY COUNCIL OF THE CITY OF REPUBLIC, MISSOURI, APPROVING THE ANNEXATION OF APPROXIMATELY 5.0 ACRES OF LAND LOCATED AT 688 SOUTH KANSAS AVENUE AND ADJACENT RIGHT-OF-WAY

WHEREAS, the City of Republic, Missouri, (herein called the "City" or "Republic") is a municipal corporation and Charter City located in Greene County, Missouri, being duly created, organized, and existing under the laws of the State of Missouri; and

WHEREAS, a voluntary petition for the annexation of approximately 5.0 acres of land located at 688 South Kansas Avenue and adjacent right-of-way has been filed with the Community Development Department; and

WHEREAS, the realty described in such petition is adjacent and contiguous to the present corporate limits of the City of Republic, Missouri; and

WHEREAS, the City Council of the City of Republic held a Public Hearing on the said petition on July 21, 2020, such hearing being held not less than fourteen days nor more than sixty days after the receipt of the petition requesting annexation; and

WHEREAS, at said Public Hearing, all interested persons, corporations or political subdivisions were afforded the opportunity to present evidence regarding the proposed annexation; and

WHEREAS, notice of said Public Hearing was published July 1, 2020, in the *Greene County Commonwealth*, a newspaper of general circulation authorized to publish legal notices, such Public Hearing being held not less than seven days after the date of publication of such notice; and

WHEREAS, no written objections to the proposed annexation were filed with the City Council within fourteen days after the date of said Public Hearing; and

WHEREAS, the City Council has found that the proposed annexation is reasonable and necessary for the proper development of the City of Republic and the City has the ability to furnish normal municipal services to the area within a reasonable time.

NOW, THEREFORE, BE IT ORDAINED BY THE CITY COUNCIL OF THE CITY OF REPUBLIC AS FOLLOWS:

Section 1: The following described realty is hereby annexed into, and made a part of, the City of Republic, Missouri, and its boundaries are hereby extended to include the same:

Approximately 5.0 acres located at 688 South Kansas Avenue and adjacent right-of-way

All of the North 5 acres of the South 12 acres of the West 25 acres of the North One-Half (N1/2) of Government Lot Two (2) of the Northwest Quarter (NW1/4) of Section Thirty (30), Township Twenty-eight (28) North, Range Twenty-three (23) West, in Greene County, Missouri, except that part taken or used for roads.

Annexing that part of the existing East right-of-way of South Kansas Avenue adjoining, adjacent to and or part of the following described tract of land.

The North 5 acres of the South 12 acres of the West 25 acres of the North One-half (N1/2) of Government Lot Two (2) of the Northwest Quarter (NW1/4) of Section Thirty (30), Township Twenty-eight (28) North, Range Twenty-three (23) West, in Greene County, Missouri. Reference Deed Book 2940, Page 0775.

Section 2. The City Clerk is hereby directed to cause three certified copies of this Ordinance to be filed with the Greene County Recorder of Deeds.

Section 3. The City Clerk is hereby directed to forward to the director of revenue of the State of Missouri by United States registered mail or certified mail a certified copy of this Ordinance.

Section 4. The whereas clauses are hereby specifically incorporated herein by reference.

Section 5. The provisions of this Ordinance are severable, and if any provision hereof is declared invalid, unconstitutional, or unenforceable, such determination shall not affect the validity of the remainder of this Ordinance.

Section 6. This Ordinance shall take effect and be in force from and after its passage as provided by law.

PASSED AND APPROVED at a regular meeting of the City Council of the City of Republic, Missouri, this _____ day of _____ 2020.

Jeff Ussery, Mayor

Attest:

Laura Burbridge, City Clerk

Approved as to Form:  Digitally signed by Scott Ison
Date: 2020.06.25 13:03:31 -05'00', Scott Ison, City Attorney

Final Passage and Vote: _____

ANNX 20-003: 688 S Kansas Ave

Vicinity Map

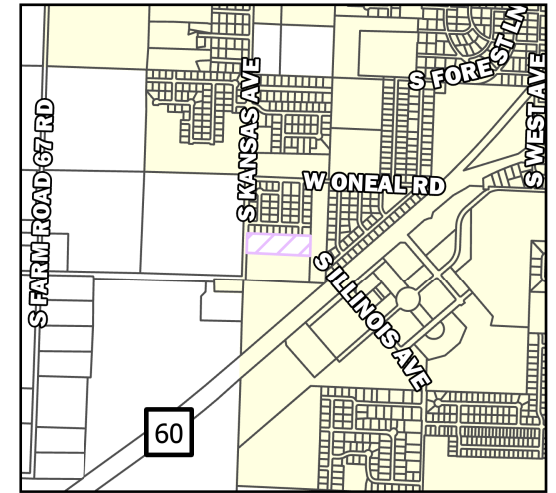

Legend

-  Parcels
-  Republic City Limits
-  ANNX 20-003

Parcel Owner: Cleo Smith
Parcel Address: 688 S Kansas Ave
Area: 5 Acres
Existing Zoning: Agricultural (Greene County)
Future Land Use Designation: Low Density Residential

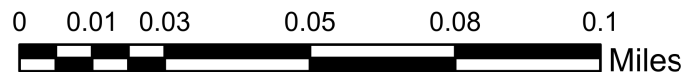

City of Springfield GIS



ANNX 20-003: 688 S Kansas Ave

Item 8.

Future Land Use Map

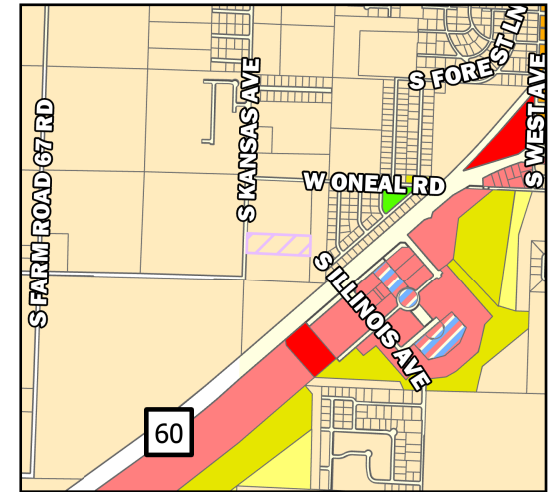
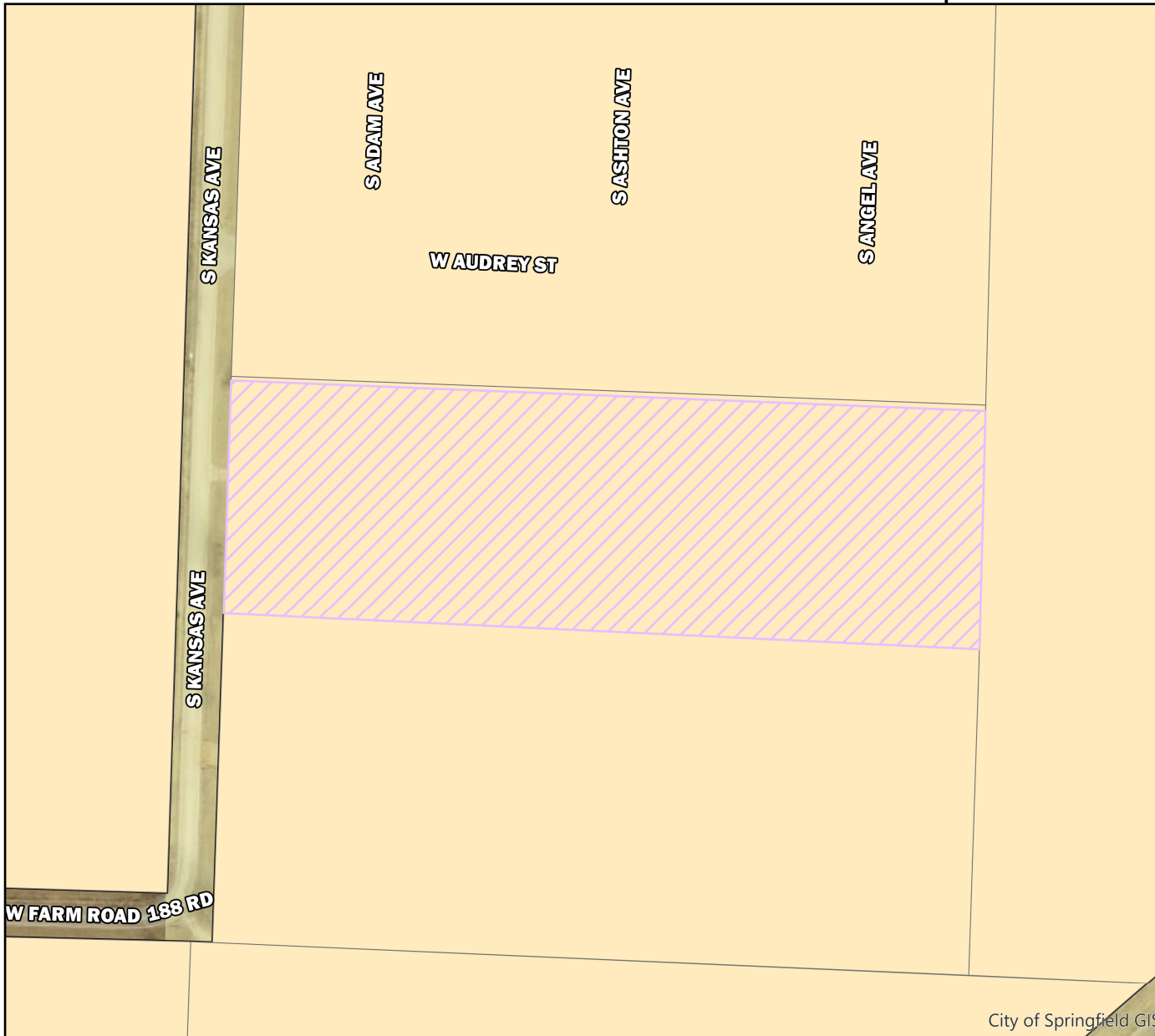

Legend

- Parcels
- ANNX 20-003
- Future Land Use
 - Low Density Residential
 - High Density Residential
 - Med Density Residential
 - Main Street District
 - C-1
 - C-2
 - M-1
 - M-2
 - Park
 - Planned Business Park
 - Public Land Use
 - School Land Use

Parcel Owner: Cleo Smith
Parcel Address: 688 S Kansas Ave
Area: 5 Acres
Existing Zoning: Agricultural (Greene County)
Future Land Use Designation: Low Density Residential

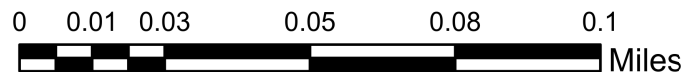

ANNX 20-003: 688 S Kansas Ave

Item 8.

Zoning Map

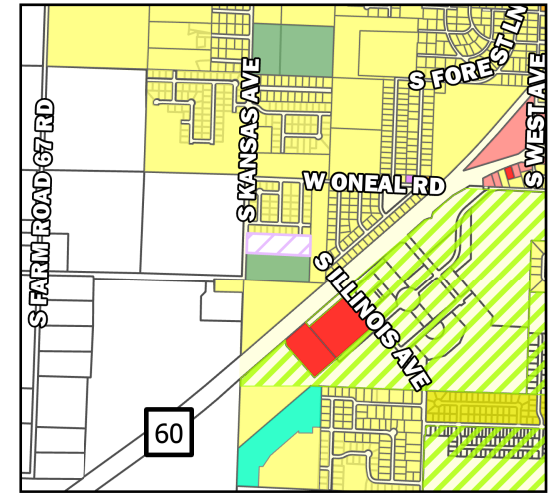

Legend

- Parcels
- ANNX 20-003
- Zoning**
- AG Agricultural
- C-1 Commercial
- C-2 General Commercial
- C-3 General Commercial
- M-1 Light Manufacturing
- M-2 Heavy Manufacturing
- PDD Planned Development
- R1-L Single Family Low Density
- R1-M Single Family Medium Density
- R1-H Single Family High Density
- R1-Z Zero Lot Line Residential
- R-2 Two-family Residential
- R-3 Multi-family Residential

Parcel Owner: Cleo Smith
 Parcel Address: 688 S Kansas Ave
 Area: 5 Acres
 Existing Zoning: Agricultural (Greene County)
 Future Land Use Designation: Low Density Residential

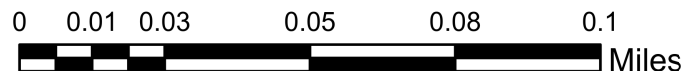

688 SOUTH KANSAS AVENUE LEGAL DESCRIPTION:

All of the North 5 acres of the South 12 acres of the West 25 acres of the North One-Half (N1/2) of Government Lot Two (2) of the Northwest Quarter (NW1/4) of Section Thirty (30), Township Twenty-eight (28) North, Range Twenty-three (23) West, in Greene County, Missouri, except that part taken or used for roads.

ADJACENT ROW LEGAL DESCRIPTION (PROVIDED BY RANDAL, 06-17-20):

Annexing that part of the existing East right-of-way of South Kansas Avenue adjoining, adjacent to and or part of the following described tract of land.

The North 5 acres of the South 12 acres of the West 25 acres of the North One-half (N1/2) of Government Lot Two (2) of the Northwest Quarter (NW1/4) of Section Thirty (30), Township Twenty-eight (28) North, Range Twenty-three (23) West, in Greene County, Missouri. Reference Deed Book 2940, Page 0775.

**VOLUNTARY PETITION FOR ANNEXATION TO
THE CITY OF REPUBLIC**

We, the undersigned, hereinafter referred to as the Petitioners, for our petition to the City Council of the City of Republic state and allege as follows:

- 1. That we are the owner of all fee interests of record in the real estate in Greene County, Missouri, described as follows, to wit:

(LEGAL DESCRIPTION ATTACHED)

- 2. That the said real estate is not now a part of any incorporated municipality.
- 3. That the said real estate is contiguous to the existing corporate limits of the City of Republic, Missouri.
- 4. That we request that the said real estate be annexed to, and included within the corporate limits of, the City of Republic, Missouri, as authorized by the provisions of Section 71.012, RSMo.
- 5. That we request the City Council of the City of Republic to cause the required notice to be published and to conduct the public hearing required by law and to thereafter adopt an ordinance extending the limits of the City of Republic to include the above described real estate.

Dated this 6/3 day of Republic, 2020

Owner's Signature: Sandra S. Smith Date: 6/3/20

State of Missouri)
) ss
County of Greene)

I, Judith M. Kipp a notary public, do hereby certify that on the 3rd day of June 2020 personally appeared before me, Sandra S. Smith), who being by me first duly sworn, (severally) declared that he is (they are) the person(s) who signed the foregoing document, and that the statements therein contained are true.

Judith M. Kipp
Notary Public
JUDITH M. KIPP

(NOTARIAL SEAL)

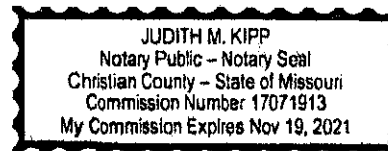



AGENDA ITEM ANALYSIS

Project/Issue Name: 20-R-24 A Resolution of the City Council of the City of Republic, Missouri, Awarding the Bid for the Parking Lot and Driveway Paving at the Republic Animal Control Facility.

Submitted By: Garrett Brickner, Assistant Community Development Director

Date: July 21, 2020

Issue Statement

To award paving of the parking lot and driveway for the Animal Control Facility to American Paving Co. Inc.

Discussion and/or Analysis

The City of Republic requested bids to pave approximately:

7869 square feet of concrete or asphalt parking and driveway for Animal control center including 6 in. curb & gutter on both sides of the driveway from 1 ft behind storm pipe to edge of right-of-way (ROW), approximately 103 linear feet. Pavement in ROW shall be 8in bituminous asphalt, 8 in concrete, or 7 in reinforced concrete. all sub grade preparation will be completed by the city prior to contractor work beginning.

An addendum was issued for an additional alternative bid for a larger portion of paved area than described in the original Invitation for Bid, approximately 13,107 SF of asphalt or concrete pavement. bidders were asked to submit a bid for both, Alternative A and Alternative B respectively.

The City received three bids for this project: American Paving Co. Inc. at A) \$26,685 and B) 28,744, Blevins Asphalt Construction Co. Inc. at A) \$29,115 and B) \$42,600, and Rio Contracting, LLC at A) \$48,250 and B) \$84,750. Rio Contracting submitted using concrete which is why their price is so much different than the other two.

Recommended Action

Staff recommends approval.

RESOLUTION NO. 20-R-24

A RESOLUTION OF THE CITY COUNCIL OF THE CITY OF REPUBLIC, MISSOURI, AWARDING THE BID FOR THE PARKING LOT AND DRIVEWAY PAVING AT THE REPUBLIC ANIMAL CONTROL FACILITY

WHEREAS, the City of Republic, Missouri, ("City" or "Republic") is a municipal corporation and Charter City located in Greene County, Missouri, being duly created, organized, and existing under the laws of the State of Missouri; and

WHEREAS, the City solicited sealed bids for the parking lot and driveway paving at the Republic Animal Control Facility (herein called the "Project"); and

WHEREAS, three vendors provided duly submitted bids for the Project and the lowest bidder was American Paving Co. Inc., all bids being on file with the City Clerk; and

WHEREAS, the City Council desires to accept the lowest, responsible bid to govern the Project.

NOW, THEREFORE, BE IT RESOLVED BY THE CITY COUNCIL OF THE CITY OF REPUBLIC, MISSOURI, AS FOLLOWS:

Section 1. The submitted bid from American Paving Co. Inc., attached hereto as "Attachment 1" and incorporated herein, is accepted for the Project at the unit prices shown thereon and not to exceed \$28,744.00.

Section 2. The City Administrator, or designee, on behalf of the City of Republic, is authorized to enter into an Agreement with American Paving Co. Inc., for the Project, said Agreement to be in substantially the same form as "Attachment 2".

Section 3. The City Administrator, or designee, on behalf of the City, is authorized to take the necessary steps to execute this Resolution.

Section 4. The whereas clauses are hereby specifically incorporated herein by reference.

Section 5. This Resolution shall take effect after passage as provided by law.

PASSED AND APPROVED at a regular meeting of the City Council of the City of Republic, Missouri, this 21st day of July 2020.

Jeff Ussery, Mayor

Attest:

Laura Burbridge, City Clerk

Approved as to Form:  Digitally signed by Scott Ison
Date: 2020.07.20 14:25:20
-05'00', Scott Ison, City Attorney

Final Passage and Vote: _____

RESOLUTION NO. 20-R-24

Pavement for Animal Control Center Parking lot
& Driveway

City of Republic
c/o city clerk, kawa Burbridge
213 N. Main
Republic, Mo. 65738

BY 
JUL 02 2020
RECEIVED

Unit Price Curb + gutter # .25.24 per linear ft.
Asphalt Paving # 1.95 per sq. ft. with Others preparing for paving
 includes haying + furnish 3" in depth after compa Except 8" in Right Away
 Item 9.

ATTACHMENT A - BID SUBMISSION FORM

BIDDERS MUST PROVIDE THE FOLLOWING INFORMATION:

Item	Description of Work	Price
Base Bid	<p>BASE Bid</p> <ul style="list-style-type: none"> Furnishing and installation of all materials and labor for Pavement for Animal Control Center Parking lot and driveway <i>City prepares sub-grade compacted - ready for PAVING</i> All bids to include: <ul style="list-style-type: none"> Travel Expenses Freight/Shipping Costs Any other administrative costs All work must be completed by August 1st, 2020 <p>Please note any of the following:</p> <ul style="list-style-type: none"> Any labor personnel requests of the City of Republic for this project. Any other requests or responsibilities of the City of Republic for this project. <p><i>City will prepare all areas for paving. Includes grading, drainage + Base Rock - compacted for paving</i></p> <p><i>Alternate Bid</i></p>	<p>BASE Bid</p> <p>#26,685</p> <p>Includes concrete curb + gutter + Asphalt ROW 20x60 8" Asphalt Remainder 3" Asphalt</p> <p>Alternate #1 Bid</p> <p>#28,744</p> <p>Includes curb/gutter + Asphalt ROW 20x60 8" Asphalt Remainder 3" Asphalt</p>

in compliance with this invitation for Bid and to all terms, conditions, and specifications imposed therein and hereby incorporated by reference, the undersigned offers and agrees to furnish the goods and/or services described herein.

City of Republic - Pavement for Animal Control Center Parking lot and driveway 312 N Main St., Republic, MO 65738	Company Legal Name:
	 <p>American Paving Co. Inc. 354 S. Wren Rogersville, MO 65742</p>
	Address:
Telephone: 417-425-4915	<i>John Killingsworth</i>
Facsimile: N/A	Signed Dated July 2, 2020
E-mail: americanpaving@att.net	
Cellular: 417-425-4915 John	Printed Title John Killingsworth
417-425-9907 Andy	Bidders Federal ID Number: 47-0859396

To be submitted with Vendor's Bid (MUST BE COMPLETED)

X We DO NOT take exception to the IFB Documents/Requirements.

 We TAKE exception to the IFB Documents/Requirements as follows (MUST SPECIFY EXCEPTIONS):

CITY OF REPUBLIC STATEMENT OF "NO BID" * ADDENDA

Bidder acknowledges receipt of the following addendum:

RETURN THIS PAGE ONLY IF YOUR COMPANY PROVIDES THE PRODUCTS/SERVICES BEING BID AND DECLINES TO DO SO.

Addendum No. 1

Addendum No.

WE, THE UNDERSIGNED, HAVE DECLINED TO BID ON YOUR IFB * FOR DESCRIPTION FOR THE FOLLOWING REASON(S):

Addendum No.

 SPECIFICATIONS ARE TOO "TIGHT," I.E. GEARED TOWARD ONE BRAND OR MANUFACTURER ONLY (PLEASE EXPLAIN BELOW).

Addendum No.

Addendum No.

 INSUFFICIENT TIME TO RESPOND TO INVITATION FOR BID.

 OUR PRODUCT SCHEDULE WOULD NOT PERMIT US TO PREFORM.

Print Email americanpaving@att.net

Print Federal Tax ID No. 47-0859396

CONTRACTOR AGREEMENT

THIS CONTRACTOR AGREEMENT (“Agreement”) is entered into this ____ day of _____, 2020, by and between the City of Republic Missouri (“City”) and American Paving Co. Inc., (“Contractor”), collectively referred to as “Parties”.

WITNESSETH:

WHEREAS, City is a municipal corporation and Charter City located in Greene County, Missouri; and

WHEREAS, Contractor is a Missouri Corporation located at 354 S. Wren, Rogersville, Missouri, 65742, with at SSN/Federal Tax ID Number of 47-0859396; and

WHEREAS, City solicited sealed bids through an Invitation for Bid, hereinafter described on **Exhibit A – Invitation for Bid**, which is attached hereto and incorporated herein; and

WHEREAS, Contractor submitted a bid that was received by the City, which bid is attached hereto and incorporated herein as **Exhibit B – Bid Submittal**; and

WHEREAS, Contractor has become the lowest responsible bidder for furnishing the supervision, labor, tools, equipment, materials and supplies and for the services described in **Exhibit C – Description of Work**, which is attached hereto and incorporated herein; and

WHEREAS, City desires to engage Contractor for the pavement of the Animal Control parking lot and driveway (“Project”), hereinafter described on **Exhibit C – Description of Work**.

NOW, THEREFORE, in consideration of the covenants and agreements hereinafter set forth, the City and Contractor agree as follows:

1. Ability to Contract: Contractor warrants that it has the legal ability to enter into this Agreement and fulfill the terms contained herein.
2. Manner and Time for Completion: The Contractor will furnish all supervision, labor, tools, equipment, materials and supplies necessary to perform, and to perform said work at Contractor's own expense in accordance with the Agreement and any applicable city ordinances and state and federal laws within the time specified in this Agreement.
3. Terms and Conditions: In addition to the requirements to comply with applicable city, state and federal law, the Contractor shall become familiar with the technical specifications and requirements for construction projects of the City and shall comply with those provisions applicable to this project.
4. Sales Tax Exemption: The Agreement price does not include and the City shall not pay any sales or use taxes on the materials used in the project. Pursuant to the provisions of RSMo. Section 144.062, the City will provide the Contractor with a Project Exemption

Certificate and a Missouri Tax Exemption letter from the City to use in purchasing materials on a tax-free basis. It will be the Contractor's responsibility to provide the documentation to any subcontractor. These documents will be used solely for purchase of materials being directly incorporated into or consumed in the construction of the work under this Agreement.

5. Payment Shall Not Exceed: The City hereby agrees to pay the Contractor for the work done pursuant to this Agreement according to the payment schedule set forth in this Agreement upon acceptance of the work by the City and in accordance with the rates and/or amounts stated in the **Exhibit B – Bid Submittal**, which by reference is made a part hereof. It is expressly understood that in no event will the total compensation and reimbursement to be paid to the Contractor under the terms of this Agreement exceed the sum of \$28,744.00, unless specifically and mutually agreed to in writing by both the City and the Contractor. No partial payment to the Contractor shall operate as approval of acceptance of work done or materials furnished hereunder.
6. Payment: One lump sum payment will be made by City to Contractor once all work is fully completed and performed as determined by the City and upon receipt of all applicable lien waivers, final release, prevailing wage documents, and other documents that may be required by City.
7. Contingency Set Aside: The Agreement amount set forth in paragraph 5 above may include amount specified in the **Notice of Award** which shall be set aside as a contingency allowance. Although the contingency allowance may be included in the total amount of the Agreement, the Contractor shall not be entitled to be paid any portion of the contingency allowance unless and until specifically authorized by written change order to the City's initial **Notice to Proceed**. The contingency allowance shall be authorized solely in the event additional work not included or specified in the base bid is required.
8. Prevailing Wage: If this project is valued at more than \$75,000.00, not less than the prevailing hourly rate of wages, as set out in the wage order attached to and made part of the specification for work under the contract, must be paid to all workers performing work under this Agreement (see Section 290.250, RSMo). The Contractor will forfeit a penalty to the contracting public body of \$100 per day (or portion of a day) for each worker that is paid less than the prevailing rate for any work done under this Agreement by the Contractor or by any sub-contractor (see Section 290.250, RSMo). For detailed information on rules and occupational titles, see 8 CSR 30-3.010 through 3.060). During periods of excessive unemployment (any month immediately following two consecutive calendar months during which the level of unemployment in the state has exceeded five percent (as measured by the United States Bureau of Labor Statistics), only Missouri laborers (persons who have resided in Missouri for at least thirty days and intend to become or remain Missouri residents) and laborers from non-restrictive states (persons who are residents of a state which has not enacted state laws restricting Missouri

laborers from working on public works projects in that state, as determined by the Labor and Industrial Relations Commission), (see Excessive Unemployment section), may be employed under this Agreement, except that other laborers may be used when Missouri laborers or laborers from non-restrictive states are not available, or are incapable of performing the particular type of work involved, if so certified by the Contractor and approved by the contracting officer. (See Sections 290.550 through 290.580, RSMO).

- ~~9. Performance Bond and Labor & Materials Payment Bond: The Contractor shall execute a Performance and Maintenance Bond and a Labor and Materials Payment Bond with surety approved by the City and on the forms approved by the City, each bond shall be in the amount of \$XX,XXX.00, conditioned upon the full and faithful performance of all major terms and conditions of this Agreement and payment of all labor and material supplies. It is further mutually agreed between the parties hereto that if at any time after the execution of this agreement and the surety bond(s) hereto attached for its faithful performance and payment of labor and material suppliers, the City shall deem the surety or sureties upon such bond(s) to be unsatisfactory, or if, for any reason, such bond(s) ceases to be adequate to cover the performance of the work, the Contractor shall, at its expense, within five days after the receipt of notice from the City to do so, furnish an additional bond or bonds, in such form and amount, and with such surety or sureties as shall be satisfactory to the City. In such event no further payment to the Contractor shall be deemed to be due under this Agreement until such new or additional security for the faithful performance of the work and the payment of labor and material suppliers shall be furnished in a manner and form satisfactory to the City. The corporate surety on any performance or payment bond must be licensed by the State of Missouri and if the required bond exceeds \$25,000 must be listed in the United States Treasury Circular 570.~~
10. Insurance Requirements: Without limiting any of the other obligations or liabilities of the Contractor, the Contractor shall secure and maintain at its own cost and expense, throughout the duration of this Agreement and until the work is completed and accepted by the City, insurance of such types and in such amounts as may be necessary to protect it and the interests of the City against all hazards or risks of loss as hereunder specified or which may arise out of the performance of this Agreement. The form and limits of such insurance, together with the underwriter thereof in each case, are subject to approval by the City. Regardless of such approval, it shall be the responsibility of the Contractor to maintain adequate insurance coverage at all times during the term of the Contract. Failure of the Contractor to maintain coverage shall not relieve it of any contractual responsibility or obligation or liability under this Agreement.

The certificates of insurance, including evidence of the required endorsements hereunder or the policies, shall be filed with the City within 10 days after the date of the receipt of **Notice of Award** to the Contractor and prior to the start of work. All insurance policies shall provide 30 days written notice to be given by the insurance company in question

prior to modification or cancellation of such insurance. Such notices shall be mailed, certified mail, return receipt requested, to:

City of Republic, Legal Department, 221 North Main, Republic, MO 65738

The minimum coverage for the insurance referred to herein shall be in accordance with the requirements established below:

- a. Workers' Compensation.....Statutory coverage per RSMo. 287.010 et seq
Employer's Liability.....\$1,000,000.00
 - b. Commercial General Liability Insurance, including coverage for Premises, Operations, Products and Completed Operations, Contractual Liability, Broad Form Property Damage, Independent Contractors, Explosion, Collapse, and Underground Property Damage and endorsed for blasting if blasting required. Such coverage shall apply to bodily injury and property damage on an "Occurrence Form Basis" with limits of \$2,905,664 for all claims arising out of a single accident or occurrence and \$435,849 for any one person in a single accident or occurrence.
 - c. Automobile Liability Insurance covering bodily injury and property damage for owned, non-owned and hired vehicles, with limits of \$2,905,664 for all claims arising out of a single accident or occurrence and \$435,849 for any one person in a single accident or occurrence.
 - d. Subcontracts. In case any or all of this work is sublet, the Contractor shall require the subcontractor to procure and maintain all insurance required in this Paragraph, Insurance Requirements, hereof and in like amounts. Contractor shall require any and all subcontractors with whom it enters into a contract to perform work on this project to protect the City through insurance against applicable hazards or risks and shall, upon request of the City, provide evidence of such insurance.
 - e. Notice: The Contractor and/or subcontractor shall furnish the City prior to beginning the work, the policy as specified in this Paragraph, Insurance Requirements, and satisfactory proof of carriage of all the insurance required by this contract, with the provision that policies shall not be canceled, modified or non-renewed without 30 days written notice to the City.
 - f. Pending Legislation: In the event the scope or extent of the City's tort liability as a governmental entity as described in Section 537.600 through 537.650 RSMo. is broadened or increased during the term of this Agreement by legislative or judicial action, the City may require Contractor, upon 10 days written notice, to execute an Agreement addendum whereby the Contractor agrees to provide, at a price not exceeding Contractor's actual increased premium cost, additional liability insurance coverage as the City may require to protect the City from increased tort liability exposure as the result of such legislative or judicial action. Any such additional insurance coverage shall be evidenced by an appropriate certificate of insurance and shall take effect within the time set forth in the addendum.
11. Contractor's responsibility for subcontractors: The Contractor shall be as fully responsible to the City for the acts and omissions of its subcontractors, and of persons either directly or indirectly employed by them, as Contractor is for the acts and omissions

of persons it directly employs. Contractor shall cause appropriate provisions to be inserted in all subcontracts relating to this work, to bind all subcontractors to Contractor by all the terms herein set forth, and insofar as applicable to the work of subcontractors and to give Contractor the same power regarding termination of any subcontract as the City may exercise over Contractor under any provisions of this contract. Nothing contained in this Agreement shall create any contractual relation between the subcontractor and the City or between any subcontractors.

12. Liquidated Damages: Time of completion of work by the Contractor is of the essence. Should Contractor, or in the case of default, the surety, fail to complete the work within the time specified in this Agreement, or within such extra time as may be allowed in accordance with the terms of this Agreement, Contractor (or surety) shall be liable to the City in the amount of \$200.00 per day for each and every calendar day that the Agreement remains uncompleted after the time allowed for completion, as liquidated damages, and not as a penalty, it being stipulated that actual damages to the City and the public arising from Contractor's failure to timely complete the work would be difficult, if not impossible, to ascertain. The amount assessed as liquidated damages may be withheld from any moneys otherwise due to Contractor from the City.
13. Termination: City reserves the right to terminate this Agreement by giving at least 5 days prior written notice to the Contractor, without prejudice to any other rights or remedies of the City should the Contractor be adjudged a bankrupt, or if Contractor should make a general assignment for the benefit of its creditors, or if a receiver should be appointed for Contractor or for any of its property, or if Contractor should persistently or repeatedly refuse or fail to supply enough properly skilled workmen or proper material, or if Contractor should refuse or fail to make prompt payment to any person supplying labor or materials for the work under the contract, or persistently disregard instructions of the City or fail to observe or perform any provisions of this Agreement.
14. City's Right to Proceed: In the event this Agreement is terminated pursuant to this Agreement, Termination, then the City may take over the work and prosecute the same to completion, by contract or otherwise, and Contractor and its sureties shall be liable to the City for any costs over the amount of this Agreement thereby occasioned by the City. In any such case, the City may take possession of, and utilize in completing the work, such materials, appliances and structures as may be on the work site and are necessary for completion of the work. The foregoing provisions are in addition to, and not in limitation of, the rights of the City under any other provisions of this Agreement, city ordinances, and state and federal laws.
15. Termination for Convenience of City: The City shall have the right at any time by written notice to Contractor to terminate and cancel this Agreement, without cause, for the convenience of the City, and Contractor shall immediately stop work. In such event City shall not be liable to Contractor except for payment for actual work performed prior to such notice in an amount proportionate to the completed Agreement price and for the actual costs of preparations made by Contractor for the performance of the cancelled portions of this Agreement, including a reasonable allowance of profit applicable to the actual work performed and such preparations. Anticipatory profits and consequential damages shall not be recoverable by Contractor.

16. Delay by City: City and Contractor agree that the schedule of services to be provided by the Contractor under this Agreement may depend upon timely fulfillment of City responsibilities. If the City is unable to provide services and/or facilities as specified in this Agreement, and/or causes delays to the project beyond Contractor's control, the Contractor shall be entitled to an extension of the time for completion of this Agreement but such time of completion shall be extended no more than 1 day for each day of delay caused by the City. Any such agreement to modify or extend the time of completion shall be made in writing by formal addendum to this Agreement. The time of application of liquidated damages shall not begin until after the amended date for contract/phase completion. The time of completion shall not be extended because of delay caused by the City unless and until the Contractor has notified the City, in writing, that the City has caused a delay; such notice shall be made not later than 7 days after the beginning of the delay caused by the City.
17. Guards, Lights, Fencing: Contractor agrees that during the performance of said work, it will maintain proper guards for the prevention of accidents and put up and maintain suitable and sufficient lights and fencing.
18. Liability and Indemnity:
- a. In no event shall City be liable to Contractor for direct, special, indirect, liquidated, or consequential damages. The maximum liability of City shall be limited to the amount of money to be paid or received by City under this Agreement.
 - b. Contractor shall defend, indemnify and save harmless City, its elected or appointed officials, agents and employees from and against any and all liability, suits, damages, costs (including attorney fees), losses, outlays and expenses from claims in any manner caused by, or allegedly caused by, or arising out of, or connected with, this Agreement, or the work or any subcontract thereunder (the Contractor hereby assuming full responsibility for relations with subcontractors), including, but not limited to, claims for personal injuries, death, property damage, or for damages from the award of this Agreement to Contractor, notwithstanding any possible negligence, whether sole or concurrent, on the part of the City, its officials, agents and employees.
 - c. Contractor shall indemnify and hold City harmless from all wages or overtime compensation due any employees in rendering services pursuant to this Agreement or any subcontract, including payment of reasonable attorneys' fees and costs in the defense of any claim made under the Fair Labor Standards Act, the Missouri Prevailing Wage Law or any other local, federal or state law.
 - d. The indemnification obligations of Contractor hereunder shall not be limited by any limitations as to the amount or type of damages, compensation or benefits payable by or for the Contractor, under any local, federal or state law, to any person asserting the claim against City, its elected or appointed officials, agents and employees, for which indemnification is sought.
 - e. The indemnification obligations herein shall not negate, abridge or reduce in any way any additional indemnification rights of City, its elected or appointed

officials, agents and employees, which are otherwise available under statute, or in law or equity.

- f. Contractor affirms that it has had the opportunity to recover the costs of the liability insurance required in this Agreement in its contract price. Contractor's obligation under this Agreement to defend, indemnify, and hold harmless any person from that person's own negligence or wrongdoing is limited to the coverage and limits of the applicable insurance required of Contractor under this Agreement.
19. Payment for Labor and Materials: The Contractor agrees and binds itself to pay for all labor done, and for all the materials used in the construction of the work to be completed pursuant to this Agreement.
20. Agreement Documents: The Agreement documents shall consist of the following:
- a. This Agreement;
 - b. Exhibit A – Invitation for Bid
 - c. Exhibit B – Bid Submittal
 - d. Exhibit C – Description of Work
 - e. Notice of Award
 - f. Notice to Proceed
 - g. E-Verify Affidavit
 - h. OSHA Safety Training Affidavit
 - i. All Duly Executed Change Orders
 - ~~j. Payment Bond~~
 - ~~k. Performance and Maintenance Bond~~

This Agreement, together with the other documents enumerated in this Paragraph, Agreement Documents, forms the Agreement between the parties. These documents are as fully a part of this Agreement as if attached hereto or repeated herein.

21. Subsurface Conditions: Contractor agrees that information contained in the published reports and public actions of the Missouri Division of Geology and Land Survey shall be conclusive and binding upon the Contractor as to what subsurface conditions at the job site are reasonably anticipated or reasonably foreseeable.
22. Transient Employers: Every transient employer, as defined in Section 285.230, RSMo., must post in a prominent and easily accessible place at the work site a clearly legible copy of the following: (1) The notice of registration for employer withholding issued to such transient employer by the Director of Revenue; (2) Proof of coverage of Worker's Compensation Insurance or self-insurance signed by the transient employer and verified by the Department of Revenue through records of the Division of Worker's Compensation; and, (3) The notice of registration for Unemployment Insurance issued to such transient employer by the Division of Employment Security. Any transient employer failing to comply with these requirements shall, under Section 285.234, RSMo. be liable for a penalty of \$500 per day until the notices required by this section are posted as required by that Statute.
23. Nonresident/Foreign Contractors: The Contractor shall procure and maintain during the life of this Agreement:

- a. If the Contractor is a foreign corporation, a certificate of authority to transact business in the State of Missouri from the Secretary of State, unless exempt pursuant to the provisions of Section 351.570 RSMo.
 - b. A certificate from the Missouri Director of Revenue evidencing compliance with the transient employer financial assurance law, unless exempt pursuant to the provisions of Section 285.230 RSMo.
24. E-Verify and Safety Training Compliance Requirements: All Proposers/Contractors for contracts/agreements exceeding \$5,000.00 shall by sworn affidavit and provision of documentation, affirm its enrollment and participation in a federal work authorization program with respect to the employees working in connection with the contracted services. Every such business entity shall also sign an affidavit affirming that it does not knowingly employ any person who is an unauthorized alien in connection with the contracted services. Such Affidavit of Compliance shall be submitted with the Proposal on the forms included in this Agreement. Subsequent to award, each sub-contractor shall complete an Affidavit of Compliance to the same. Sub-contractor affidavits shall be submitted to the City.
25. Safety Training: Contractor shall provide the following safety training: A 10-hour Occupational Safety and Health Administration (“OSHA”) construction safety program for all employees who will be on-site at this Project. The construction safety program shall include a course in construction safety and health that is approved by OSHA or a similar program approved by the Missouri Department of Labor and Industrial Relations which is at least as stringent as an approved OSHA program as required by Section 292.675, RSMo.
- a. Require its on-site employees to complete a construction safety program within 60 days after the date work on the Project commences.
 - b. Acknowledges and agrees that any of the Contractor’s employees found on the project site with documentation of the successful completion of a construction safety program shall be required to produce such documentation within 20 days, or will be subject to removal from the Project.
 - c. Require all of its sub-contractors to comply with the requirements of this Paragraph, Safety Training, and Section 292.675 RSMo.
26. Notice of Penalties for Failure to Provide Safety Training: Contractor shall be liable for penalties for failure to provide safety training as follows:
- a. Pursuant to Section 292.675 RSMo. the Contractor shall forfeit to the City as a penalty \$2,500.00, plus \$100.00 for each on-site employee employed by the Contractor or its Sub-contractor, for each calendar day, or portion thereof. Such on-site employee is employed without the construction safety training required in Paragraph 24, Safety Training.
 - b. The penalty described in this Paragraph shall not begin to accrue until the time periods described in Paragraph 24, Safety Training, have elapsed.
 - c. Violation of Paragraph 24, Safety Training, and imposition of the penalty described in this Section shall be investigated and determined by the Missouri Department of Labor and Industrial Relations.
27. Payment Withheld for Violations of Safety Training Provisions: In the event that the Missouri Department of Labor and Industrial Labor Relations has determined that a

violation of Section 292.675 RSMo has occurred and that a penalty as described in Paragraph 25, Notice of Penalties for Failure to Provide Safety Training, shall be assessed, City shall withhold and retain all sums and amounts due and owing when making payments to Contractor.

28. Federal Funding: If the subject of this Agreement is financed in whole or in part from Federal funds, this Agreement shall be subject to all applicable federal statutes, rules and regulations, including provisions of the Davis-Bacon Act, 40 U.S.C. §3141 *et seq.*, and the “Federal Labor Standards Provisions,” incorporated into this Agreement. Where the Missouri Prevailing Wage Law and the Davis-Bacon Act require payment of different wages for work performed under this Agreement, the Contractor and all Subcontractors shall pay the greater of the wages required under either law.
29. General Independent Contractor Clause: This Agreement does not create an employee/employer relationship between the Parties. It is the Parties' intention that the Contractor will be an independent contractor and not the City's employee for all purposes, including, but not limited to, the application of the Fair Labor Standards Act minimum wage and overtime payments, Federal Insurance Contribution Act, the Social Security Act, the Federal Unemployment Tax Act, the provisions of the Internal Revenue Code, Missouri Revenue and Taxation laws, Missouri Workers' Compensation and Unemployment Insurance laws. The Contractor will retain sole and absolute discretion in the judgment of the manner and means of carrying out the Contractor's activities and responsibilities hereunder. Contractor agrees that it is a separate and independent enterprise from the City, that it has a full opportunity to find other business, that it has made its own investment in its business, and that it will utilize a high level of skill necessary to perform the work. This Agreement shall not be construed as creating any joint employment relationship between the Contractor and the City, and the City will not be liable for any obligation incurred by the Contractor, including but not limited to unpaid minimum wages and/or overtime premiums.
30. Occupational License: Contractor shall obtain and maintain an occupational license with the jurisdiction this Project is located in. The cost for this occupational license shall borne by the Contactor. No Agreement shall be executed by the City until this occupational license has been obtained.
31. Nondiscrimination: Contractor agrees in the performance of this Agreement not to discriminate on the grounds or because of race, creed, color, national origin or ancestry, sex, religion, handicap, age, or political opinion or affiliation, against any employee of Contractor or applicant for employment and shall include a similar provision in all subcontracts let or awarded hereunder.
32. Ownership in Work: Contractor will have and will gain no ownership or other interest in Project in this Agreement.
33. Conflict of Interest: In accepting this Agreement, Contractor certifies that no salaried officer or employee of the City, and no member of the City Council or Mayor, has a financial interest, direct or indirect, in this Agreement. Any federal regulations and applicable provisions in Section 105.450 *et seq.*, RSMo. shall not be violated.
34. Waiver: No provision of the Agreement documents shall be construed, expressly or by implication, as a waiver by the City of any existing or future right or remedy available by law in the event of any claim of default or breach of contract.

35. Entire Agreement: This Agreement contains the entire agreement between the Parties and supersedes all prior and contemporaneous written or oral agreements. This Agreement may not be modified or amended other than in writing as agreed and signed by all the Parties.
36. Jurisdiction and Venue: This Agreement shall be taken and deemed to have been fully executed and made by the parties herein and governed by the laws of the State of Missouri for all purposes and intents. Venue under this Agreement or any disputes that come from it shall be in the Circuit Court of Greene County, Missouri.
37. Dispute: In the event that the City is the prevailing party in any litigation arising out of or relating to this Agreement, the City shall be entitled to all reasonable attorneys' fees and expenses incurred.
38. Liability: Nothing in this Agreement shall be construed to create any liability on behalf of the City for any direct, special, indirect, liquidated, or consequential damages.
39. Execution: This Agreement may be executed in any number of counterparts and each shall be deemed to be an original if signed by all Parties, but all of which together shall constitute one and the same document. The parties agree that signatures transmitted by facsimile or scanned and emailed shall have the legal effect of original signatures. At the request of either party, the parties shall promptly exchange executed original counterparts of this Agreement or any amendment.
40. Survival: This Agreement shall be binding upon and inure to the benefit of the parties hereto and their respective heirs, personal representatives, successors and assigns as provided in this Agreement.
41. Headings: The headings in this Agreement are for convenience of reference only and shall not limit or otherwise affect the meaning thereof.
42. Whereas Clauses: The "Whereas" clauses stated above are incorporated herein by reference.
43. Assignment: Contractor shall not assign any interest in this Agreement, and shall not transfer any interest in the same (whether by assignment or novation), without prior written consent of the City thereto, provided, however, that claims for money due or to become due to the Contractor from the City under this Agreement may be assigned to a bank, trust company, or other financial institution without such approval. Notice of such assignment or transfer shall be furnished in writing promptly to the City and the bond surety. Any such assignment is expressly subject to all rights and remedies of the City under this Agreement, including the right to change or delete activities from the Agreement or to terminate the same as provided herein, and no such assignment shall require the City to give any notice to any such assignee of any actions which the City may take under this Agreement.
44. Sovereign Immunity: In no event shall any language or requirement in this Agreement be construed as or constitute a waiver or limitation of City's defenses with regard to

sovereign immunity, governmental immunity, or official immunity under federal or state constitutions, statutes, and/or laws.

- 45. Severability Clause: A determination of invalidity or unconstitutionality by a court of competent jurisdiction of any clause, sentence, paragraph, section or part, of this Agreement shall not affect the validity of the remaining parts to this Agreement.
- 46. Contingent Upon Funds and Approval: This Agreement is contingent upon the City having sufficient funds available for the subject of this Agreement. Contractor shall have no right of action against City in the event City is unable to perform its obligations under this Agreement as a result of insufficient funds. Further, this Agreement is subject to and conditioned upon approval by ordinance by the City Council.
- 47. Notices: Any notice, request or demand provided for in this Agreement shall be deemed to have been given when the same shall have been personally delivered to the following offices or deposited in the United States Mail, Registered or Certified, with postage thereon prepaid as follows:

to the City: City of Republic, Missouri
 Attn: City Administrator
 213 North Main Street
 Republic, Missouri 65738

to Contractor: American Paving Co. Inc.
 354 S. Wren
 Rogersville, Missouri, 65742

[REMAINDER OF PAGE INTENTIONALLY LEFT BLANK]

IN WITNESS WHEREOF, the parties have caused this Agreement to be executed as of the day and year first above written.

CONTRACTOR

American Paving Co. Inc.

(Signature)

(Printed Name)

(Title)

CITY OF REPUBLIC

David Cameron, City Administrator

Attest: Laura Burbridge, City Clerk

Approved as to Form:

Scott Ison, City Attorney

[REMAINDER OF PAGE INTENTIONALLY LEFT BLANK]



City of Republic - Invitation for Bid

Pavement for Animal Control Center Parking lot and driveway

SEALED BIDS MUST BE PHYSICALLY RECEIVED AT REPUBLIC CITY HALL PRIOR TO **3:00 P.M. ON Thursday, July 2, 2020.**

City of Republic
C/O City Clerk, Laura Burbridge
213 N. Main
Republic MO 65738

- Bids will be opened by the buyer at REPUBLIC CITY HALL AT **3:00 P.M. ON Thursday, July 2, 2020.**
- Bids shall be submitted on the forms provided and must be manually signed by the individual authorized to legally bind the company.
- Bids shall be submitted with the **Invitation for Bid (IFB) project name or item clearly indicated on the outside of the mailing envelope.**
- Bids received after the opening date and time will be rejected.
- The attached Terms and Conditions shall become part of any purchase order resulting from this bid.
- FAXED/EMAILED BIDS WILL NOT BE ACCEPTED.
- You are invited to submit your bid to furnish the materials and/or services described herein. Please submit your prices/fees net of all discounts.

DESCRIPTION

Pavement for Animal Control Center Parking lot and driveway

Approximately 7869 square feet of concrete or asphalt parking and driveway for Animal control center including 6 in. curb & gutter on both sides of the driveway from 1 ft behind storm pipe to edge of right-of-way (ROW), approximately 103 linear feet. Pavement in ROW shall be 8 in bituminous asphalt, 8 in concrete, or 7 in reinforced concrete. all sub grade preparation will be completed by the city prior to contractor work beginning. See attached plans for details

Inquiries - All inquiries for information should be directed to:

Garrett Brickner (417) 732-3405

It is the intent of the City that this Invitation for Bid promotes competitive bidding. It shall be the Vendor's responsibility to advise the City if any language, requirements, etc. any combination thereof, inadvertently restricts or limits the requirements stated in this Invitation for Bid to a single source. Such notification must be submitted in writing and must be received by the City contact listed above not later than three (3) days prior to the bid opening date.

INSTRUCTION TO BIDDERS

1. Opening Location: The Bid will be opened at the Republic City Hall 213 N. Main at 3:00 P.M. ON Thursday, July 2, 2020.

- a. All bidders or their representatives are invited to attend the opening of the IFB.

2. IFB Delivery Requirements: Any Bids received after the above stated time and date will not be considered. It shall be the sole responsibility of the bidder to have their Bid delivered to Republic City Hall for receipt on or before the due date and time indicated.

- a. If a Bid is sent by U.S. Mail, the bidder shall be responsible for its timely delivery to Republic City Hall.
- b. Bids delayed by mail shall not be considered, shall not be opened, and shall be rejected.
- c. Arrangements may be made for their return at the bidder's request and expense.
- d. Bids may be mailed to Republic City Hall and accepted if the signed bid form and required information was mailed and received prior to the due date and time.
- e. Bids sent by email will not be accepted.

Sealed and Marked: If sent by mail, one original signed Bid shall be submitted in one sealed package, clearly marked on the outside of the package with the **IFB project name.**

clearly indicated on the outside of the mailing envelope and addressed to.

**City of Republic
C/O City Clerk, Laura Burbridge
213 N. Main
Republic MO 65738**

03. Legal Name and Signature: Bids shall clearly indicate the legal name, address, and telephone number of the bidder (company, firm, corporation, partnership, or individual).

- a. Bids shall be manually signed above the printed name and title of signer on the Affidavit of Compliance page.
- b. The signer shall have the authority to bind the company to the submitted Bid.
- c. Failure to properly sign the Bid form shall invalidate same, and it shall not be considered for award.

04. Corrections: No erasures are permitted.

- a. If a correction is necessary, draw a single line through the entered figure and enter the corrected figure above it.
- b. Corrections must be initialed by the person signing the Bid.

05. Clarification and Addenda: Each bidder shall examine all Invitation for Bid documents and shall judge all matters relating to the adequacy and accuracy of such documents.

- a. Any inquiries or suggestions, concerning interpretation, clarification, or additional information pertaining to the Invitation for Bid shall be made through the listed City contact in writing or through email.
- b. The City of Republic shall not be responsible for oral interpretations given by any City employee, representative, or others.
- c. The issuance of written addenda is the official method whereby interpretation, clarification, or additional information can be given.
- d. It shall be the responsibility of each bidder, prior to submitting their Bid, to contact listed City contact with questions or inquiries.

06. IFB Expenses: There is no expressed or implied obligation for the City of Republic to reimburse responding firms and the City will not reimburse for any expenses incurred in preparing responses to this request.

07. Irrevocable Offer: Any Bid may be withdrawn up until the due date and time set for opening of the IFB. Any Bid not so withdrawn shall, upon opening, constitute an irrevocable offer for a minimum period of 90

days to sell to the City the goods or services set forth in the IFB, until one or more of the Bids have been duly accepted by the City.

08. **Responsive and Responsible Bidder:** To be responsive, a bidder shall submit a Bid which conforms in all material respects to the requirements set forth in the Invitation for Bid. To be a responsible bidder, the bidder shall have the capability in all respects to perform fully the contract requirements, and the tenacity, perseverance, experience, integrity, reliability, capacity, facilities, equipment and credit which will ensure good faith performance. The lowest responsible bidder shall mean the bidder who makes the lowest Bid to sell goods or services of a quality which conforms closest to the quality of goods or services set forth in the specifications or otherwise required by the City and who is known to be fit and capable to perform the Bid as made.
09. **Reserved Rights:** The City reserves the right to make such investigations as it deems necessary to make the determination of the bidder's responsiveness and responsibility.
- a. Such information may include, but shall not be limited to: current financial statement, verification of availability of equipment and personnel, and past performance records.
10. **The Right to Audit:** The bidder agrees to furnish supporting detail as may be required by the City to support charges or invoices, to make available for audit purposes all records covering charges pertinent to the purchase, and to make appropriate adjustments in the event discrepancies are found.
- a. The cost of any audit will be paid by the City.
 - b. The City shall have the right to audit the bidder's records pertaining to the work/product for a period of three (3) years after final payment.
11. **Applicable Law:** All applicable laws and regulations of the State of Missouri and the City including the City Procurement Regulations and Procedures will apply to any resulting agreement, contract, or purchase order.
- a. Any involvement with the City Procurement shall be in accordance with the Procurement Regulations and Procedures.
12. **Right to Protest:** Appeals and remedies are provided for in the City Procurement Regulations.
- a. Protestors shall seek resolution of their complaints initially with the City Purchasing Agent.
 - b. Any protest shall state the basis upon which the solicitation or award is contested and shall be submitted within ten (10) calendar days after such aggrieved person knew or could have reasonably been expected to know of the facts giving rise thereto.
13. **Ethical Standards:** With respect to this IFB, if any bidder violates or is a party to a violation of the general ethical standards of the City Procurement Code or the State of Missouri Statutes, such bidder may be disqualified from furnishing the goods or services for which the Bid is submitted and shall be further disqualified from submitting any future Bids.
14. **Collusion:** By offering a submission to this Invitation for Bid, the bidder certifies the bidder has not divulged, discussed, or compared the Bid with other bidders and has not colluded with any other bidder or parties to this IFB whatsoever. Also, the bidder certifies, and in the case of a joint Bid, each party thereto certifies as to their own organization, that in connection with this IFB:
- a. Any prices and/or cost data submitted have been arrived at independently, without consultation, communication, or agreement for the purpose of restricting competition, as to any matter relating to such prices and/or cost data, with any other bidder or with any competitor.
 - b. Any prices and/or cost data for this Bid have not knowingly been disclosed by the bidder and will not knowingly be disclosed by the bidder prior to the scheduled opening directly or indirectly to any other bidder or to any competitor.
 - c. No attempt has been made or will be made by the bidder to induce any other person or firm to submit or not to submit a Bid for the purpose of restricting competition.
 - d. The only person or persons interested in this Bid, principal or principals are named therein and that no person other than therein mentioned has any interest in this Bid or in the contract to be entered into.
 - e. No person or agency has been employed or retained to solicit or secure this contract upon an agreement or understanding for a commission, percentage, brokerage, or contingent fee

exempting bona fide employees or established commercial agencies maintained by the Purchaser for the purpose of doing business.

15. **Contract Forms:** Any agreement, contract, or purchase order resulting from the acceptance of a Bid shall be on forms either supplied by or approved by the City.
16. **Liability and Indemnity:**
- a. In no event shall the City be liable to the Contractor for special, indirect, liquidated, incidental, or consequential damages, except those caused by the City's gross negligence or willful or wanton misconduct arising out of or in any way connected with a breach of this contract. The maximum liability of the City shall be limited to the amount of money to be paid or received by the City under this contract.
 - b. The Contractor shall defend, indemnify and save harmless the City, its elected or appointed officials, agents and employees from and against any and all liability, suits, damages, costs (including attorney fees), losses, outlays and expenses from claims in any manner caused by, or allegedly caused by, or arising out of, or connected with, this contract, or the work or any subcontract thereunder (the Contractor hereby assuming full responsibility for relations with subcontractors), including, but not limited to, claims for personal injuries, death, property damage, or for damages from the award of this contract to Contractor.
 - c. The Contractor shall indemnify and hold the City harmless from all wages or overtime compensation due any employees in rendering services pursuant to this agreement or any subcontract, including payment of reasonable attorneys' fees and costs in the defense of any claim made under the Fair Labor Standards Act, the Missouri Prevailing Wage Law or any other federal or state law.
17. **IFB Forms, Variances, and Alternates:** Bids must be submitted on attached City IFB forms, although additional information may be attached.
- a. Bidders must indicate any variances from the City requested specifications and/or terms and conditions, on the IFB Affidavit of Compliance.
 - b. Otherwise, bidders must fully comply with the City requested specifications and terms and conditions. Alternate Bids may or may not be considered at the sole discretion of the City Purchasing Agent.
18. **Bid Form:** All blank spaces must be completed with the appropriate response.
- a. The bidder must state the price, written in ink, for what is proposed to complete each item of the project.
 - b. Bidders shall insert the words "no bid" in the space provided for an item for which no Bid is made.
 - c. The bidder shall submit an executed Bid form, affidavit of compliance with other requested documents.
19. **Modifications or Withdrawal of Bid:** A modification for a Bid already received will be considered only if the modification is received prior to the time announced for opening of Bids.
- a. All modifications shall be made in writing, executed, and submitted on the same form and manner as the original Bid.
 - b. Modifications submitted by telephone, fax, or email will not be considered.
20. **No Bid:** If not submitting a Bid, respond by returning the "Statement of No Bid" no later than the stated Bid opening time and date, and explain the reason in the space provided.
21. **Errors in Bids:** Bidders or their authorized representatives are expected to fully inform themselves as to the conditions, requirements, and specifications before submitting Bids; failure to do so will be at the bidder's own risk. Neither law nor regulations make allowance for errors either of omission or commission on the part of bidders. In case of error of extension of prices in the Bid, the unit price shall govern.
22. **Prices:** Bid give both unit price and extended total.
- a. Price must be stated in units of quantity specified in the bidding specifications. In case of discrepancy in computing the amount of the Bid, the unit price of the Bid will govern.

- b. All prices shall be F.O.B. destination, freight prepaid (unless otherwise stated in special conditions). FOB, as used in this IFB, shall mean that Seller, at their own expense, shall transport the equipment and/or materials and bear the risk of loss from Sellers location to a specified location in the City of Republic, MO 65738. Buyer shall not take title to the materials or equipment until it is delivered and accepted by Buyer at the address specified within the City of Republic.
 - c. Each item must be bid separately and no attempt is to be made to tie any item or items in with any other item or items.
 - d. If a bidder offers a discount on payment terms, the discount time will be computed from the date of satisfactory delivery at place of acceptance and receipt of correct invoice at the office specified.
 - e. Payment terms shall be Net 30 if not otherwise specified.
 - f. Pre-payment terms are not acceptable.
23. **Discounts:** Any and all discounts except cash discounts for prompt payments must be incorporated as a reduction in the Bid price and not shown separately.
- a. The price as shown on the Bid shall be the price used in determining award(s).
24. **Descriptive Information:** All equipment, materials, and articles incorporated in the product/work covered by this IFB are to be new and of suitable grade for the purpose intended.
- a. Brand or trade names referenced in specifications are for comparison purposes only.
 - b. Bidders may submit Bids on items manufactured by other than the manufacturer specified when an "or equal" is stated.
25. **Deviations to Specifications and Requirements:** When bidding on an "or equal," Bids must be accompanied with all descriptive information necessary for an evaluation of the proposed material or equipment such as the detailed drawings and specifications, certified operation and test data, and experience records.
- a. Failure of any bidder to furnish the data necessary to determine whether the product is equivalent, may be cause for rejection of the specific item(s) to which it pertains.
 - b. All deviations from the specifications must be noted in detail by the bidder on the Affidavit of Compliance form, at the time of submittal of Bid.
 - c. The absence of listed deviations at the time of submittal of the Bid will hold the bidder strictly accountable to the specifications as written.
 - d. Any deviation from the specifications as written and accepted by the City may be grounds for rejection of the material and/or equipment when delivered.
26. **Samples (if required):** (NOT APPLICABLE)
27. **Quality Guaranty:** If any product delivered does not meet applicable specifications or if the product will not produce the effect that the bidder represents to the City, the bidder shall pick up the product from the City at no expense. Also, the bidder shall refund to the City any money which has been paid for same.
- a. The bidder will be responsible for attorney fees in the event the bidder defaults and court action is required.
28. **Quality Terms:** The City reserves the right to reject any or all materials if, in its judgment, the item reflects unsatisfactory workmanship, manufacturing, or shipping damages.
29. **Tax-Exempt:** The City is exempt from sales taxes and Federal Excise Taxes: Missouri Tax ID Number 12492990.
30. **Awards:**
- a. Unless otherwise stated in the Invitation for Bid, cash discounts for prompt payment of invoices will not be considered in the evaluation of prices. However, such discounts are encouraged to motivate prompt payment.
 - b. As the best interest of the City may require, the right is reserved to make awards by item, group of items, all or none or a combination thereof; to reject any and all Bids or waive any minor irregularity or technicality in Bids received.

- c. Awards will be made to the Bidder whose Bid (1) meets the specifications and all other requirements of the Invitation for Bid and (2) is the lowest and best Bid, considering price, delivery, responsibility of the bidder, and all other relevant factors.
31. **Authorized Product Representation:** The successful bidder(s) by virtue of submitting the name and specifications of a manufacturer's product will be required to furnish the named manufacturer's product.
- a. By virtue of submission of the stated documents, it will be presumed by the City that the bidder(s) is legally authorized to submit and the successful bidder(s) will be legally bound to perform according to the documents.
32. **Regulations:** It shall be the responsibility of each bidder to assure compliance with OSHA, EPA, Federal, State of Missouri, and City rules, regulations, or other requirements, as each may apply.
- a. **E-VERIFY COMPLIANCE REQUIREMENTS:** All Contractors/Contractors for contracts exceeding five thousand dollars shall by sworn affidavit and provision of documentation, affirm its enrollment and participation in a federal work authorization program with respect to the employees working in connection with the contracted services. Every such business entity shall also sign an affidavit affirming that it does not knowingly employ any person who is an unauthorized alien in connection with the contracted services.
- b. Proposers are informed the Project is subject to the requirements of Section 292.675, RSMo., which requires all contractors or subcontractors doing work on the Project to provide and require its on-site employees to complete a ten (10) hour course in construction safety and health approved by the Occupational Safety and Health Administration ("OSHA") or a similar program approved by the Missouri Department of Labor and Industrial Relations which is at least as stringent as an approved OSHA program. The training must be completed within sixty (60) days of the date work on the Project commences. On-site employees found on the worksite without documentation of the required training shall have twenty (20) days to produce such documentation.
- c. Pursuant to Section 292.675 RSMo. The Contractor shall forfeit to the City as a penalty two thousand five hundred dollars (\$2,500.00), plus one hundred dollars (\$100.00) for each on-site employee employed by the Contractor or its Subcontractor, for each calendar day, or portion thereof, Such on-site employee is employed without the construction safety training required in the above paragraph.
- d. Section 208.009 RSMo. shall apply to any contracts awarded under this bid.
33. **Termination of Award:** Any failure of the bidder to satisfy the requirements of the City shall be reason for termination of the award.
- a. Any Bid may be rejected in whole or in part for any reason by the City.
34. **Royalties and Patents:** The successful bidder(s) shall pay all royalties and license fees for equipment or processes in conjunction with the equipment being furnished.
- a. Bidder shall defend all suits or claims for infringement of any patent right and shall hold the City harmless from loss on account or cost and attorney's fees incurred.
35. **Equal Employment Opportunity Clause:** The City of Republic, in accordance with the provision of Title VI of the Civil Rights Act of 1964 (78 Stat. 252) and the Regulations of the Department of Commerce (15 CFR, Part 8) issued pursuant to such Act, hereby notifies all bidders that affirmatively ensure that in any contract entered into pursuant to this advertisement that minority businesses will be afforded full opportunity to submit Bids in response to this advertisement and will not be discriminated against on the grounds of race, color, or national origin in consideration for award.
36. **Prevailing Wages:** If the public works construction project is valued at more than \$75,000, the successful bidder shall comply with applicable State provisions concerning the payment of prevailing wages on public works projects. Accordingly, all workers performing work under the City Contractor Agreement shall be paid not less than the prevailing hourly rate of wages as determined by the Department of Labor and Industrial Relations of the State of Missouri (or "MoDOLIR").
37. **Insurance Requirements:** Without limiting any of the other obligations or liabilities of the Contractor, the Contractor shall secure and maintain at its own cost and expense, throughout the duration of this Contract and until the work is completed and accepted by the City, insurance of such types and in such amounts as may be necessary to protect it and the interests of the City against all hazards or risks of loss as hereunder

specified or which may arise out of the performance of the Contract Documents. The form and limits of such insurance, together with the underwriter thereof in each case, are subject to approval by the City. At a minimum, proof of Workers Compensation, Liability, and Automobile Liability insurance shall be presented. Regardless of such approval, it shall be the responsibility of the contractor to maintain adequate insurance coverage at all times during the term of the Contract. Failure of the Contractor to maintain coverage shall not relieve it of any contractual responsibility or obligation or liability under the Contract Documents. The limits of liability insurance shall be as established annually and published by the Secretary of State in the Missouri Registry. For this project, the required insurance amounts shall be: Workers' Compensation - Statutory coverage per RSMo. 287.010 et seq; Employer's Liability - \$1,000,000.00; Commercial General Liability Insurance - \$2,804,046 for all claims arising out of a single accident or occurrence and \$420,606 for any one person in a single accident or occurrence; Automobile Liability Insurance - covering bodily injury and property damage for owned, non-owned and hired vehicles, with limits of \$2,804,046 for all claims arising out of a single accident or occurrence and \$420,606 for any one person in a single accident or occurrence.

38. **Performance Bond and Labor & Materials Payment Bond:** Pursuant to RSMo. 107.170, if the project is estimated to exceed \$50,000.00, the Contractor shall execute a Performance and Maintenance Bond and a Labor and Materials Payment Bond with surety approved by the City and on the forms approved by the City, each bond shall be in the amount of the total project cost, conditioned upon the full and faithful performance of all major terms and conditions of the Agreement and payment of all labor and material supplies.
39. **Nonresident/Foreign Contractors:** The Contractor shall procure and maintain during the life of this contract:
 - a. If the Contractor is a foreign corporation, a certificate of authority to transact business in the State of Missouri from the Secretary of State, unless exempt pursuant to the provisions of Section 351.570 RSMo.
 - b. A certificate from the Missouri Director of Revenue evidencing compliance with the transient employer financial assurance law, unless exempt pursuant to the provisions of Section 285.230 RSMo.
40. **Bid Tabulation:** Bidders may request a copy of the bid tabulation of the Invitation for Bid.
41. **Budgetary Constraints:** The City reserves the right to reduce or increase the quantity, retract any item from the Bid, or upon notification, terminate entire agreement without any obligations or penalty based upon availability of funds.
42. **Additional Purchases by Other Public Agencies:** The bidder by submitting a Bid authorizes other public agencies to "Piggy-Back" or purchase equipment and services being proposed in this Invitation for Bid unless otherwise noted on the Affidavit of Compliance Form.
43. **Order of Precedence:** Any and all Special/General Conditions and Specifications attached hereto, which varies from the instruction to bidders, shall take precedence.
44. **Affidavit for Service Contracts:** The Bidder represents, in accordance with RSMO 285.530.2 that they have not employed, or subcontracted with, unauthorized aliens in connection with the scope of work to be done under the IFB and agrees to provide an affidavit to the City of Republic affirming that they have not, and will not in connection with the IFB, knowingly employ, or subcontract with, any person who is an unauthorized alien.
45. **Business License** – It will be the requirement of the contractor to acquire a City of Republic business license before they may begin work on the project.
46. **Inspection and Acceptance:** No item(s) received by the City pursuant to this contract shall be deemed accepted until the City has had reasonable opportunity to inspect the item(s).
 - a. Any item(s) which are discovered to be defective or which do not conform to any warranty of the Seller upon inspection may be returned at the seller's expense for full credit or replacement.
 - b. If at a later time, the defects were not ascertainable upon the initial inspection may also be returned at the Seller's expense for full credit or replacement.
 - c. The City's return of defective items shall not exclude any other legal, equitable or contractual remedies the City may have.
47. **Davis-Bacon Act:** If the Instructions to Bidders have indicated that the Project is financed in whole or in part from Federal funds, then this contract shall be subject to all applicable federal statutes, rules and

regulations, including provisions of the Davis-Bacon Act, 40 U.S.C. §3141 et seq., and the “Federal Labor Standards Provisions,” incorporated into this Contract. Where the Missouri Prevailing Wage Law and the Davis-Bacon Act require payment of different wages for work performed under this Contract, the Contractor and all Subcontractors shall pay the greater of the wages required under either law.

48. **Jurisdiction and Venue:** This IFB and any Agreement required under it, shall be taken and deemed to have been fully executed and made by the parties herein and governed by the laws of the State of Missouri for all purposes and intents. Venue under this Agreement or any disputes that come from it shall be in the Circuit Court of Greene County, Missouri. THE PARTIES HEREBY WAIVE THEIR RIGHT TO A JURY TRIAL UNDER ANY APPLICABLE STATUTE, COMMON LAW OR FEDERAL OR STATE CONSTITUTION.
49. **Conflict of Interest:** In participating in this IFB and accepting an Agreement, Contractor certifies that no salaried officer or employee of the City, and no member of the City Council or Mayor, has a financial interest, direct or indirect, in this Agreement. Any federal regulations and applicable provisions in Section 105.450 et seq., RSMo. shall not be violated.
50. **Sovereign Immunity:** In no event shall any language or requirement in this IFB or any Agreement that comes from this IFB be construed as or constitute a waiver or limitation of City’s defenses with regard to sovereign immunity, governmental immunity, or official immunity under federal or state constitutions, states, and/or laws.
51. **Terms:** The City of Republic reserves the right to reject any and all proposals received from this bid. It further has the right to negotiate with any qualified source, or to cancel in part or in its entirety this bid. The City also reserves the right to modify, suspend, or terminate at its sole discretion any and all aspects of this bud process, to obtain further information from any and all respondents, and to waive any defects as to form or content of the bid or any submissions by any firm. This bud does not commit the City to award a contract, to defray any costs incurred in the preparation of a response to this request, or to procure or contract for services. All submissions become the property of the City as public record. All submissions may be subject to public review upon reques

W STATE HIGHWAY 174

GENERAL NOTES:

1. CONSTRUCTION METHODS AND MATERIALS SHALL CONFORM TO THE LATEST REVISIONS OF THE STANDARD GENERAL CONDITIONS AND TECHNICAL SPECIFICATIONS FOR CONSTRUCTION FOR THE CITY OF REPUBLIC, GREENE COUNTY, MISSOURI, DATED JANUARY 8, 2015.
2. THE CONTRACTOR SHALL FIELD VERIFY ALL HORIZONTAL AND VERTICAL LINES AND GRADES OF EXISTING UTILITIES PRIOR TO THE CONSTRUCTION OF IMPROVEMENTS. THE CONTRACTOR SHALL NOTIFY THE ENGINEER IMMEDIATELY UPON DISCOVERY OF A DISCREPANCY BETWEEN THE CONSTRUCTION PLANS AND ACTUAL FIELD CONDITIONS.
3. NOTIFY THE CITY OF REPUBLIC INSPECTION AT 732-3354 AT LEAST 48 HOURS PRIOR TO CONSTRUCTION. FAILURE TO DO SO MAY CAUSE ANY OR ALL CONSTRUCTION TO BE REJECTED.
4. APPLICABLE PERMITS MUST BE OBTAINED FROM THE CITY, STATE, AND COUNTY PRIOR TO EXCAVATION WITHIN ANY RIGHT-OF-WAY, AND PRIOR TO ANY CONSTRUCTION.
5. IT SHALL BE THE CONTRACTOR'S RESPONSIBILITY TO DETERMINE THE LOCATION OF ANY UNDERGROUND UTILITIES OR OTHER OBSTRUCTIONS AND TO BE LIABLE FOR DAMAGE AND CONSEQUENT REPAIR TO SUCH IN THE COURSE OF HIS OPERATIONS.
6. ALL DISTURBED AREAS ARE TO BE RESEDED IN ACCORDANCE WITH THE CONSTRUCTION SPECIFICATIONS FOR THE CITY OF REPUBLIC, GREENE COUNTY, MISSOURI.
7. SIDEWALKS, HANDICAP RAMPS, UTILITIES, STORM WATER, AND SANITARY SEWER SHALL BE CONSTRUCTED IN ACCORDANCE TO THE "CONSTRUCTION SPECIFICATIONS FOR PUBLIC IMPROVEMENTS" FOR THE CITY OF REPUBLIC AND CURRENT ADA SPECIFICATIONS
8. THE SITE DOES NOT LIE IN 100-YEAR FLOOD PLAIN AS PER COMMUNITY PANEL NO. 29077C 0426E, DATED DECEMBER 17TH, 2010.
9. THE CONTRACTOR WILL BE RESPONSIBLE TO NOTIFY THE ENGINEER WHEN DIFFERENCES IN FIELD CONDITION AND PLANS OCCUR. ADJUSTMENT MADE IN THE FIELD WITHOUT PRIOR APPROVAL OF THE ENGINEER MAY RESULT IN UNPAID CONSTRUCTION ACTIVITY.

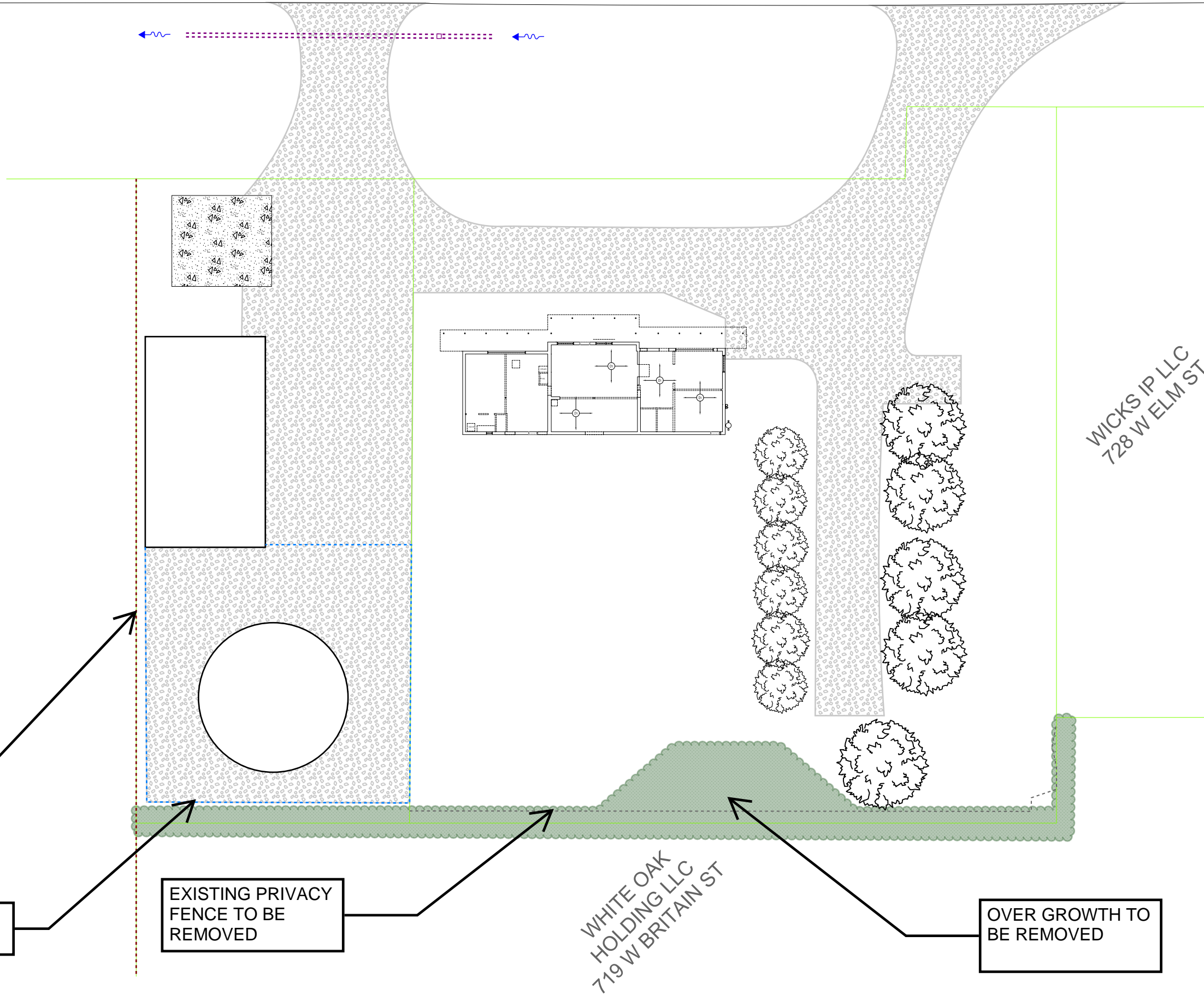

Item 9.

DATE		5/15/2020
SHEET NO.	SHEETS	
ROUTE	-	
JOB NO.	-	
CONTRACT ID	-	
PROJECT NO.	-	
REV 2		
DRAWN BY:		

DATE	DESCRIPTION
-	-
-	-
-	-
-	-

REPUBLIC ANIMAL CONTROL SITE PLAN

REPUBLIC
MISSOURI
GROWING TOGETHER

DATE	5/15/2020
SHEET NO.	SHEETS
ROUTE	-
JOB NO.	-
CONTRACT ID	-
PROJECT NO.	-
REV	2
DRAWN BY:	-

DATE	DESCRIPTION
-	-
-	-
-	-
-	-

REPUBLIC ANIMAL CONTROL SITE PLAN

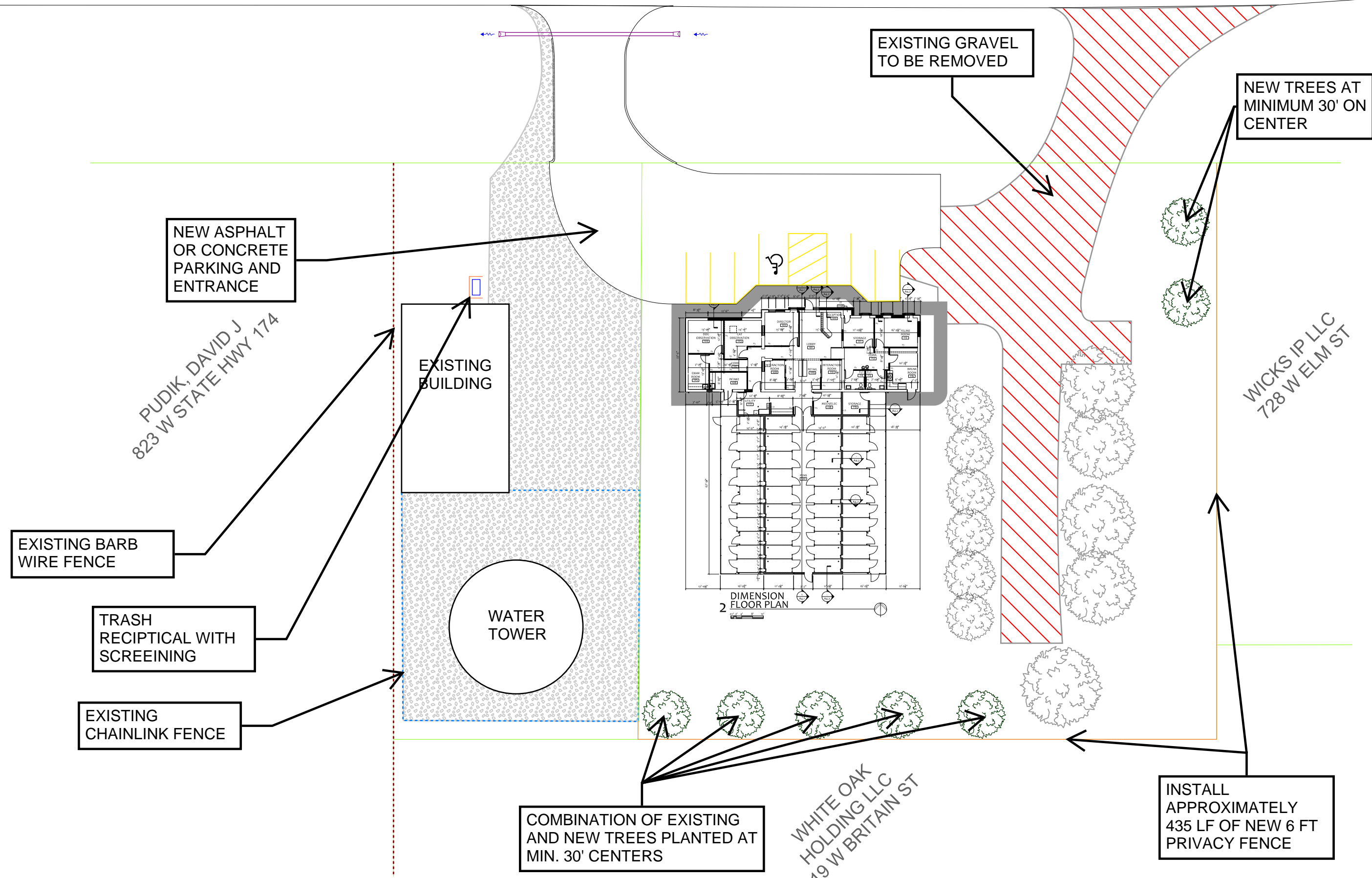

NEW ASPHALT OR CONCRETE PARKING AND ENTRANCE

PUDIK, DAVID J
823 W STATE HWY 174

EXISTING BUILDING

EXISTING GRAVEL TO BE REMOVED

NEW TREES AT MINIMUM 30' ON CENTER

WICKS IP LLC
728 W ELM ST

EXISTING BARB WIRE FENCE

TRASH RECIPTICAL WITH SCREENING

EXISTING CHAINLINK FENCE

WATER TOWER

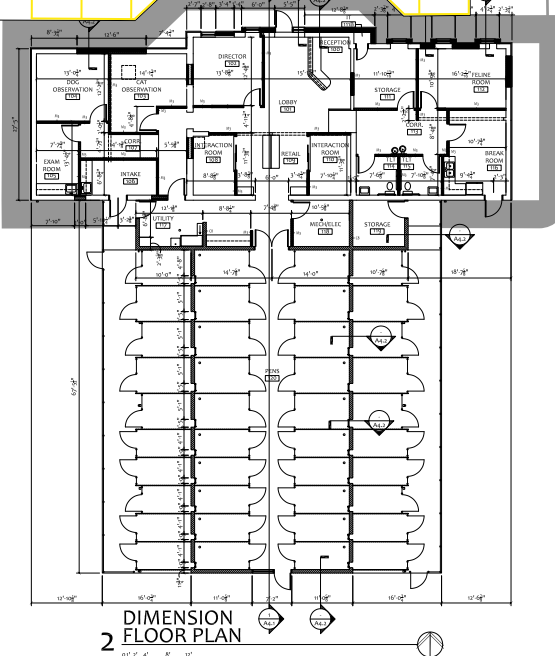

COMBINATION OF EXISTING AND NEW TREES PLANTED AT MIN. 30' CENTERS

WHITE OAK HOLDING LLC
719 W BRITAIN ST

INSTALL APPROXIMATELY 435 LF OF NEW 6 FT PRIVACY FENCE

DATE	5/15/2020
SHEET NO.	SHEETS
ROUTE	-
JOB NO.	-
CONTRACT ID	-
PROJECT NO.	-
REV	2
DRAWN BY:	-

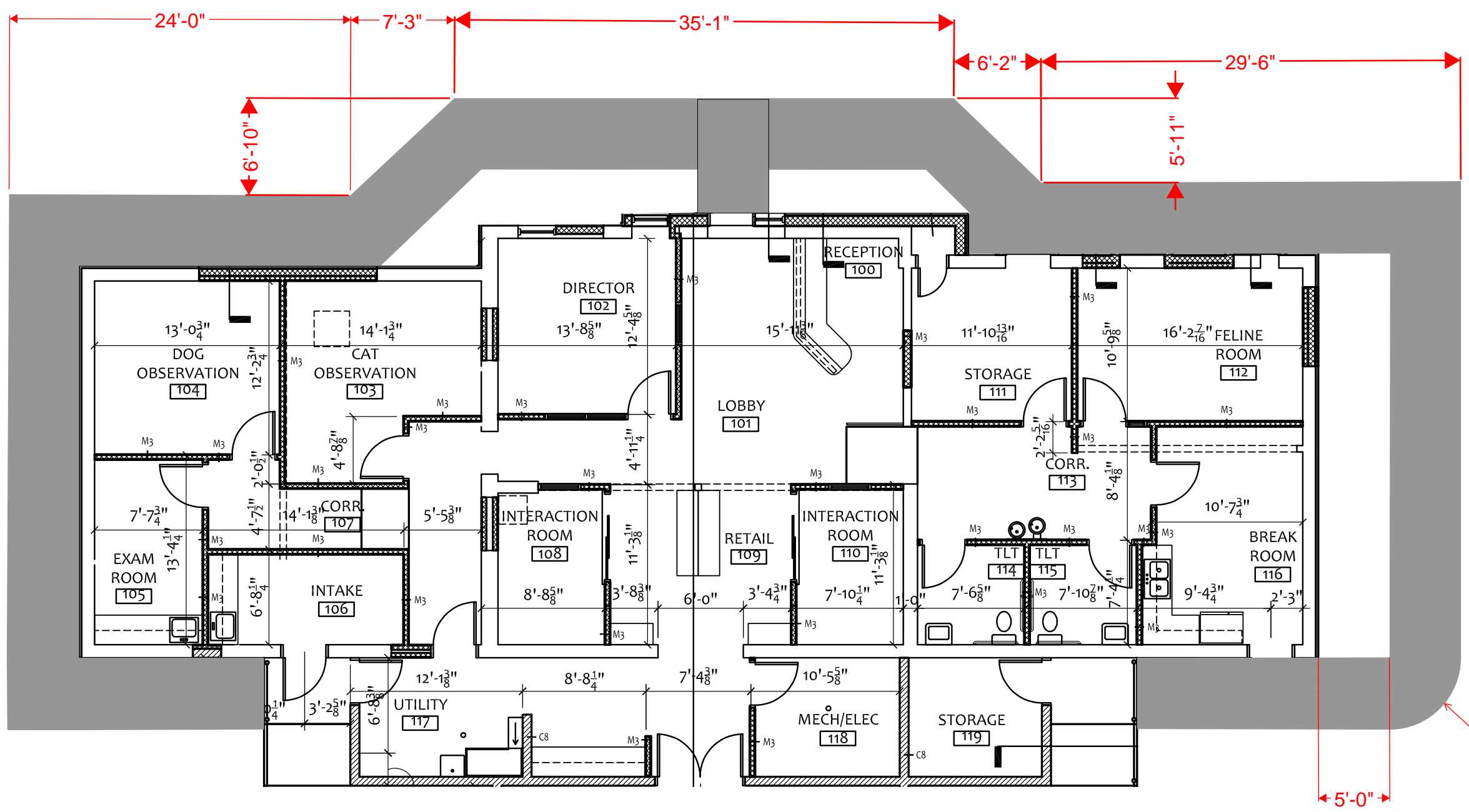

DATE	DESCRIPTION
-	-
-	-
-	-
-	-

REPUBLIC ANIMAL CONTROL SITE PLAN

1. APPROXIMATELY 1005 SF OF 4 IN SIDEWALK
2. SIDEWALK WIDTH IS 5FT UNLESS OTHERWISE INDICATED
3. MAINTAIN MIN. 5 FT WIDTH ON ALL SIDEWALK
4. SEE CITY OF REPUBLIC SPECIFICATIONS FOR CURB RAMP DETAIL

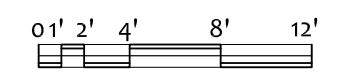

RADIUS OPTION FOR CONCRETE CORNERS

W STATE HIGHWAY 174

Item 9.

DATE	5/15/2020
SHEET NO.	SHEETS
ROUTE	-
JOB NO.	-
CONTRACT ID	-
PROJECT NO.	-
REV	2
DRAWN BY:	-

1. APPROXIMATELY 7869 SF PARKING & DRIVEWAY
2. CITY TO REPLACE EXISTING CULVERT UNDER DRIVEWAY WITH EQUAL OR GREATER DIAMETER CMP OR RCP.
3. GRADE DITCH TO DRAIN TO THE EAST MIN. 2% SLOPE
4. (6) PARKING SPACES REQUIRED - TYPICALLY 9X19 WITH (1) HANDICAP SPACE 11X19
5. APPROXIMATELY 103 LF OF CURB & GUTTER
6. SEE MODOT CURB DETAIL ON PG. 5

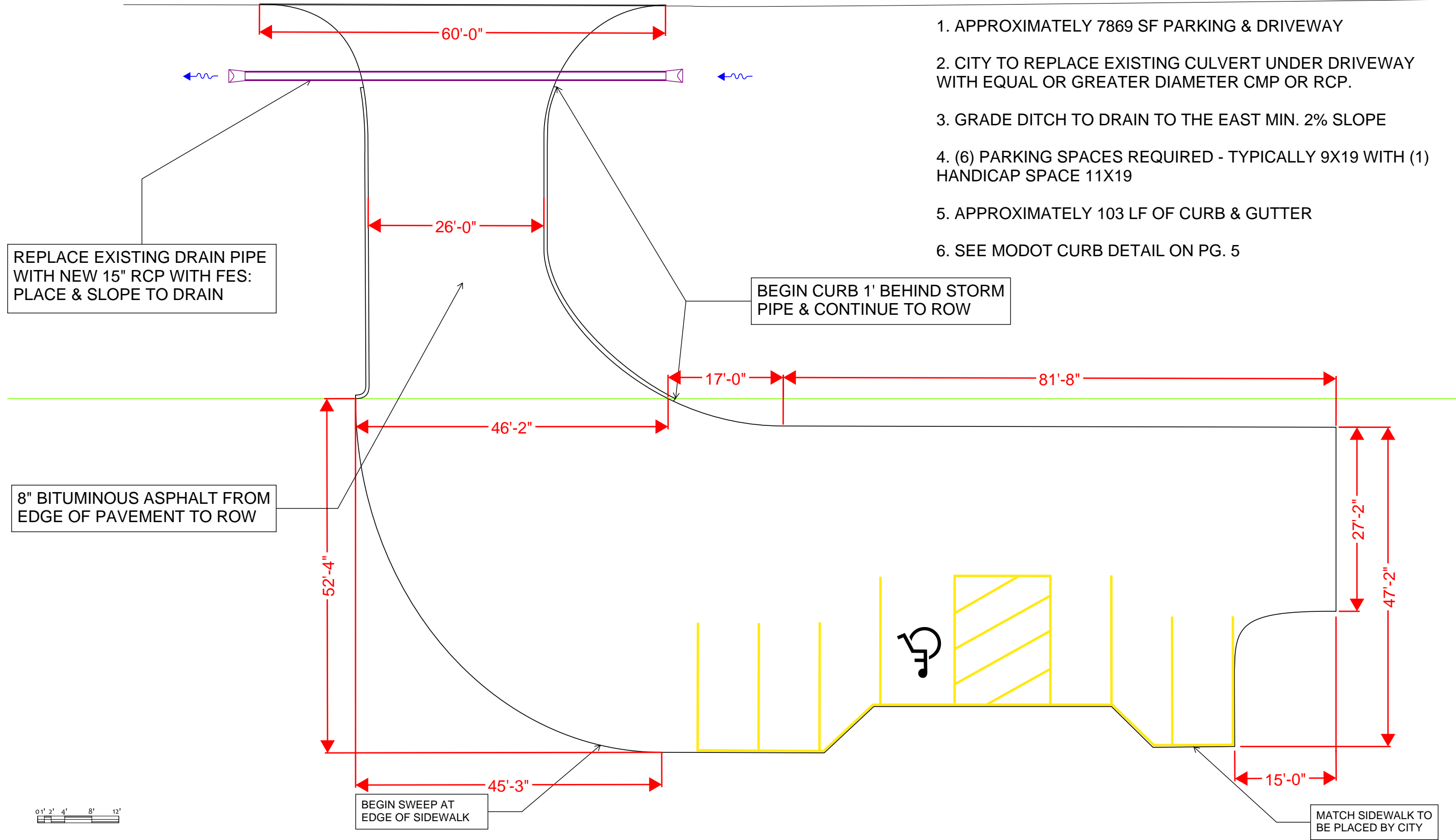

DATE	DESCRIPTION
-	-
-	-
-	-
-	-

REPUBLIC ANIMAL CONTROL SITE PLAN

REPUBLIC
MISSOURI
GROWING TOGETHER

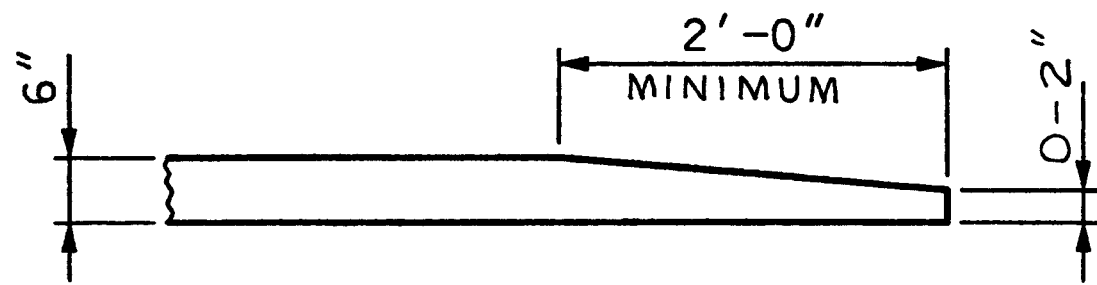

CURB TERMINUS DETAIL

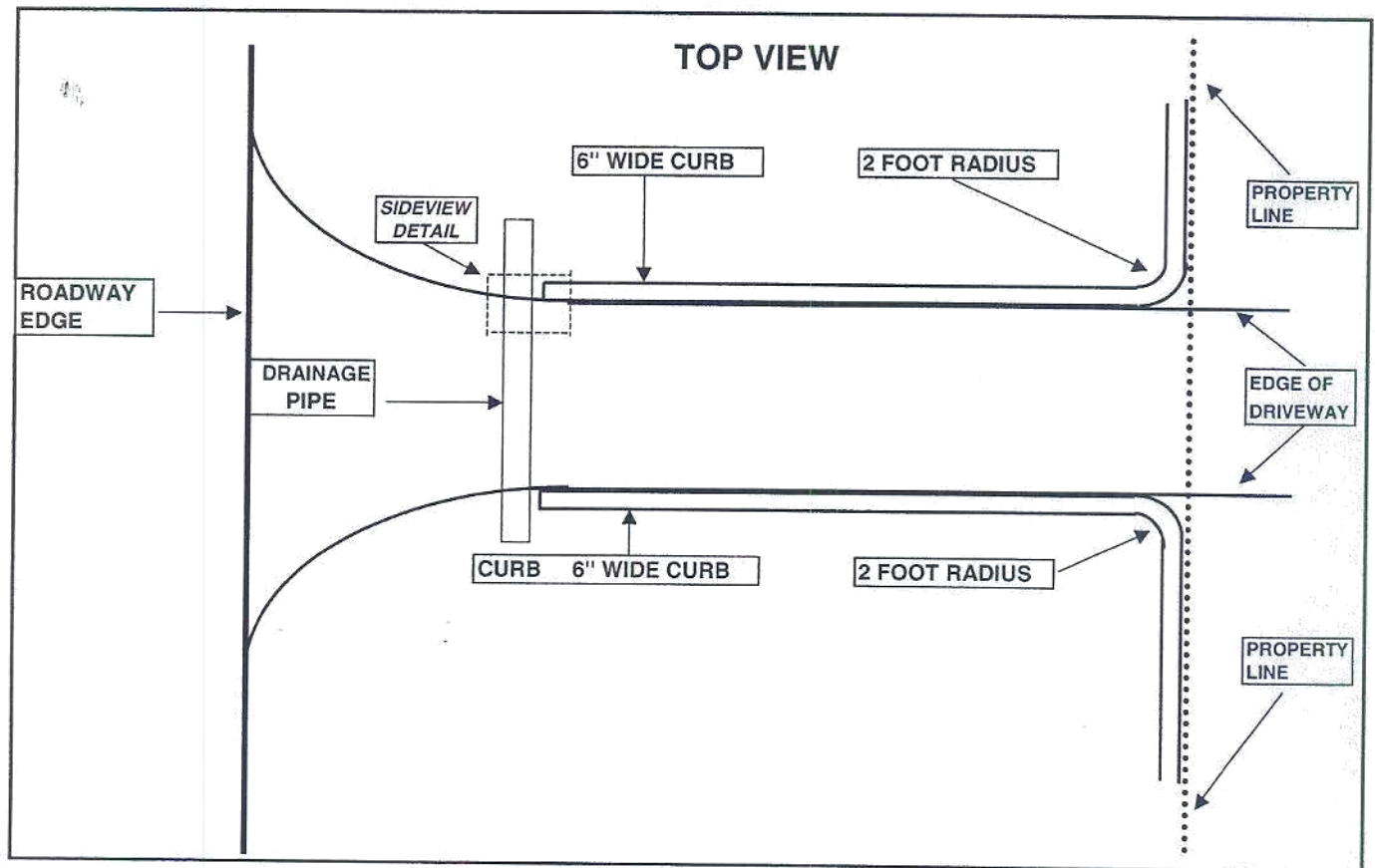
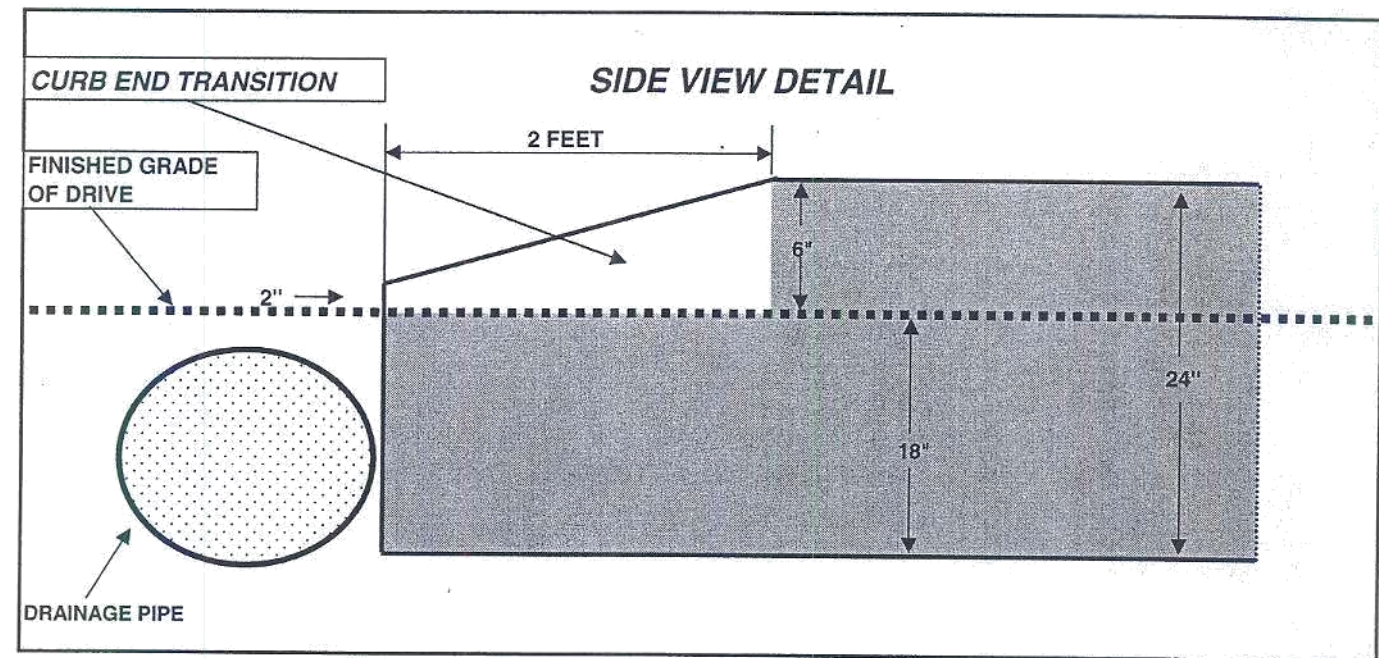

DATE	
SHEET NO.	SHEETS
ROUTE	
JOB NO.	
CONTRACT ID	
PROJECT NO.	
REV 2	
DRAWN BY:	

DATE	DESCRIPTION
-	-
-	-
-	-
-	-

REPUBLIC ANIMAL CONTROL SITE PLAN

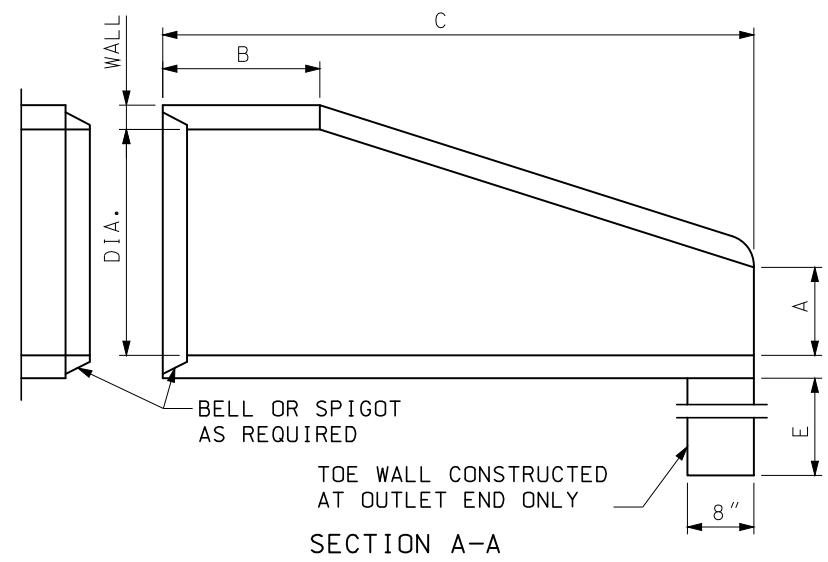

SECTION A-A

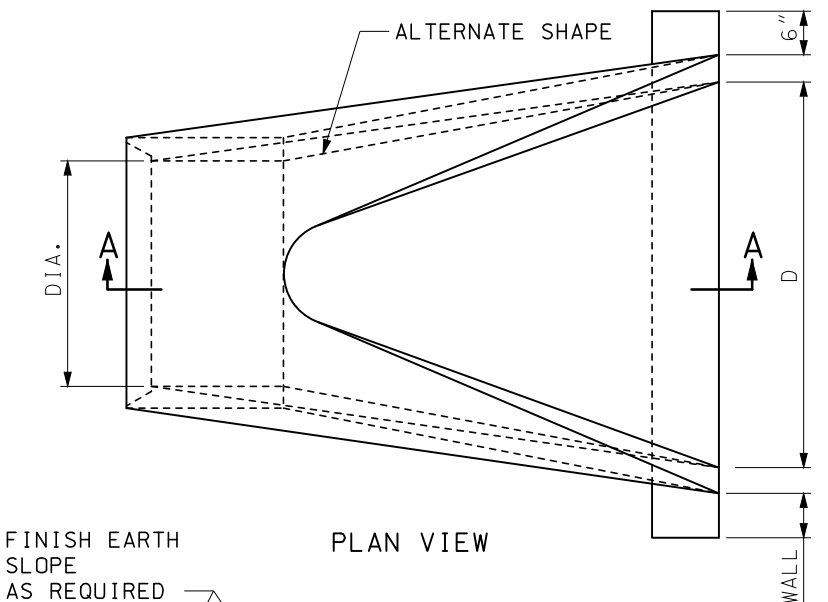

PLAN VIEW

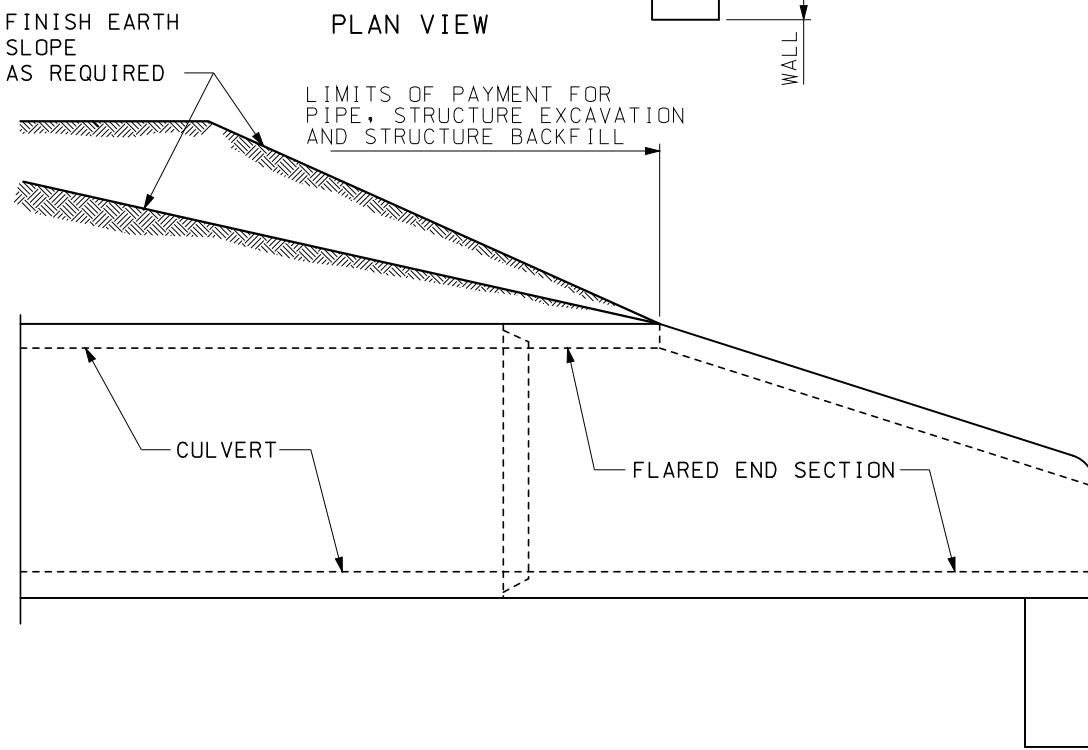

INSTALLATION DETAILS

DIMENSIONS						
DIA.	WALL	A	B MIN.	C MIN.	D	E
12"	2"	4"	4'-0"	6'	2'-0"	18"
15"	2 1/4"	6"	3'-10"	6'	2'-6"	18"
18"	2 1/2"	9"	3'-10"	6'	3'-0"	18"
21"	2 3/4"	9"	3'-2"	6'	3'-6"	18"
24"	3"	9 1/2"	2'-6"	6'	4'-0"	24"
27"	3 1/4"	10 1/2"	2'-1"	6'	4'-6"	24"
30"	3 1/2"	1'-0"	1'-7"	6'	5'-0"	24"
33"	3 3/4"	1'-2"	1'-7"	6'	5'-6"	24"
36"	4"	1'-3"	2'-10"	8'	6'-0"	24"
42"	4 1/2"	1'-9"	2'-11"	8'	6'-6"	24"
48"	5"	2'-0"	2'-2"	8'	7'-0"	24"
54"	5 1/2"	2'-3"	2'-11"	8'	7'-6"	36"
60"	6"	2'-6"	3'-3"	8'	8'-0"	36"
66"	6 1/2"	2'-0"	1'-9"	8'	8'-6"	36"
72"	7"	2'-0"	2'-9"	10'	9'-0"	36"
78"	7 1/2"	2'-3"	2'-3"	10'	9'-6"	36"
84"	8"	2'-6"	2'-0"	10'	10'-0"	36"

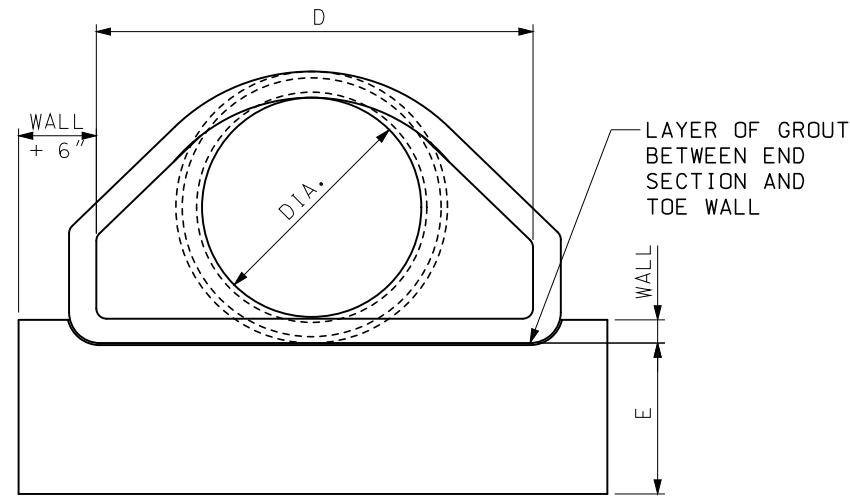

END VIEW

ADJOINING PIPE DIA.	REINFORCEMENT				
	BARREL SECTION REINFORCEMENT			FLARE SECTION REINFORCEMENT (ONE LAYER ONLY IN CENTER OF WALL)	
	CIRCULAR		ELLIPTICAL		
	INNER CAGE SQ. IN./LIN. FT.	OUTER CAGE SQ. IN./LIN. FT.	SQ. IN./LIN. FT.	AREA OF LONGITUDINAL SQ. IN./LIN. FT.	AREA OF TRANSVERSE SQ. IN./LIN. FT.
12"	0.07			0.048	0.048
15"	0.07			0.054	0.054
18"	0.07		0.07	0.060	0.060
21"	0.07		0.07	0.066	0.066
24"	0.07		0.07	0.072	0.072
27"	0.13		0.11	0.078	0.078
30"	0.14		0.12	0.084	0.084
33"	0.15		0.13	0.090	0.090
36"	0.12	0.09	0.13	0.096	0.096
42"	0.15	0.12	0.17	0.108	0.108
48"	0.18	0.14	0.20	0.120	0.120
54"	0.22	0.16	0.24	0.132	0.132
60"	0.25	0.19	0.28	0.144	0.144
66"	0.31	0.23	0.34	0.156	0.156
72"	0.35	0.21	0.39	0.170	0.170
78"	0.40	0.24	0.44	0.185	0.185
84"	0.46	0.28	0.51	0.205	0.205

GENERAL NOTES:

SLIGHT VARIATIONS IN BOTH SHAPE AND DIMENSIONS FROM THOSE SHOWN MAY BE ACCEPTED IF APPROVED BY THE ENGINEER.

NOT MORE THAN THREE LIFT HOLES MAY BE DRILLED OR CAST IN THE END SECTION FOR HANDLING AND LAYING.

LIFT LUGS OR BARS WILL BE PERMITTED IN PRECAST TOE WALLS.

TOE WALLS MAY BE CAST-IN-PLACE OR PRECAST.

STEEL FIBERS MAY BE USED IN LIEU OF REBAR OR COLD DRAWN STEEL WIRE AS PER SECTION 1032.3.4.

MISSOURI HIGHWAYS AND TRANSPORTATION COMMISSION

105 WEST CAPITOL
JEFFERSON CITY, MO 65102
1-888-ASK-MODOT (1-888-275-6636)

FLARED END SECTION

PRECAST CONCRETE

STATE OF MISSOURI
ERIC E. SCHROETER
NUMBER PE-28411
PROFESSIONAL ENGINEER

THIS SHEET HAS BEEN SIGNED, SEALED AND DATED ELECTRONICALLY.

DATE EFFECTIVE: 04/01/2016

DATE PREPARED: 2/11/2016

732.00S

SHEET NO.
1 OF 3

IF A SEAL IS PRESENT ON THIS SHEET IT HAS BEEN ELECTRONICALLY SEALED AND

ATTACHMENT A - BID SUBMISSION FORM

BIDDERS MUST PROVIDE THE FOLLOWING INFORMATION:

Item	Description of Work	Price
Base Bid	<ul style="list-style-type: none"> • Furnishing and installation of all materials and labor for Pavement for Animal Control Center Parking lot and driveway • All bids to include: <ul style="list-style-type: none"> ○ Travel Expenses ○ Freight/Shipping Costs ○ Any other administrative costs • All work must be completed by August 1st, 2020 <p>Please note any of the following:</p> <ul style="list-style-type: none"> • Any labor personnel requests of the City of Republic for this project. • Any other requests or responsibilities of the City of Republic for this project. 	<p>\$ _____</p>

In compliance with this Invitation for Bid and to all terms, conditions, and specifications imposed therein and hereby incorporated by reference, the undersigned offers and agrees to furnish the goods and/or services described herein.

<p>City of Republic – Perimeter Fencing and Kennel Barriers for the Animal Control Center</p> <p>312 N Main St., Republic, MO 65738</p>	
	<p>Company Legal Name:</p>
<p>Telephone:</p>	
<p>Facsimile:</p>	<p>Address:</p>
<p>E-mail:</p>	<p>Signed Dated</p>
<p>Cellular:</p>	<p>Printed Title</p>
	<p>Bidders Federal ID Number:</p>

To be submitted with Vendor's Bid

_____ We DO NOT take exception to the IFB Documents/Requirements.

_____ We TAKE exception to the IFB Documents/Requirements as follows:

CITY OF REPUBLIC STATEMENT OF "NO BID" * ADDENDA

Bidder acknowledges receipt of the following addendum:

RETURN THIS PAGE ONLY IF YOUR COMPANY PROVIDES THE PRODUCTS/SERVICES BEING BID AND DECLINES TO DO SO.

Addendum No. _____

Addendum No. _____

WE, THE UNDERSIGNED, HAVE DECLINED TO BID ON YOUR IFB * FOR DESCRIPTION FOR THE FOLLOWING REASON(S):

Addendum No. _____

_____ SPECIFICATIONS ARE TOO "TIGHT," I.E. GEARED TOWARD ONE BRAND OR MANUFACTURER ONLY (PLEASE EXPLAIN BELOW).

Addendum No. _____

Addendum No. _____

_____ INSUFFICIENT TIME TO RESPOND TO INVITATION FOR BID.

_____ OUR PRODUCT SCHEDULE WOULD NOT PERMIT US TO PREFORM.

Print Email _____

Print Federal Tax ID No. _____

CITY OF REPUBLIC STATEMENT OF "NO BID"

RETURN THIS PAGE ONLY IF YOUR COMPANY PROVIDES THE PRODUCTS/SERVICES BEING BID AND DECLINES TO DO SO.

WE, THE UNDERSIGNED, HAVE DECLINED TO BID ON YOUR IFB FOR THE FOLLOWING REASON(S):

_____ SPECIFICATIONS ARE TOO "TIGHT," I.E. GEARED TOWARD ONE BRAND OR MANUFACTURER ONLY (PLEASE EXPLAIN BELOW).

_____ INSUFFICIENT TIME TO RESPOND TO INVITATION FOR BID.

_____ OUR PRODUCT SCHEDULE WOULD NOT PERMIT US TO PERFORM.

_____ UNABLE TO MEET SPECIFICATIONS.

_____ UNABLE TO MEET INSURANCE REQUIREMENTS.

_____ SPECIFICATIONS UNCLEAR (PLEASE EXPLAIN BELOW).

_____ OTHER (PLEASE SPECIFY BELOW).

REMARKS:

COMPANY NAME: _____

ADDRESS: _____

SIGNATURE AND TITLE: _____

TELEPHONE NUMBER: _____

DATE: _____

State of Missouri

EXEMPTION FROM MISSOURI SALES AND USE TAX ON PURCHASES

Issued to:

CITY OF REPUBLIC
213 N MAIN
REPUBLIC MO 65738

Missouri Tax ID
Number: 12492990

Effective Date:
07/11/2002

Your application for sales/use tax exempt status has been approved pursuant to section 144.030.1, RSMo. This letter is issued as documentation of your exempt status.

Purchases by your Agency are not subject to sales or use tax if within the conduct of your Agency's exempt functions and activities. When purchasing with this exemption, furnish all sellers or vendors a copy of this letter. This exemption may not be used by individuals making personal purchases.

A contractor may purchase and pay for construction materials exempt from sales tax when fulfilling a contract with your Agency only if your Agency issues a project exemption certificate and the contractor makes purchases in compliance with the provisions of section 144.062, RSMo.

Sales by your Agency are subject to all applicable state and local sales taxes. If you engage in the business of selling tangible personal property or taxable services at retail, you must obtain a Missouri Retail Sales Tax License and collect and remit sales tax.

This is a continuing exemption subject to legislative changes and review by the Director of Revenue. If your Agency ceases to qualify as an exempt entity, this exemption will cease to be valid. This exemption is not assignable or transferable. It is an exemption from sales and use taxes only and is not an exemption from real or personal property tax.

Any alteration to this exemption letter renders it invalid.

If you have any questions regarding the use of this letter, please contact the Division of Taxation and Collection, P.O. Box 3300, Jefferson City, MO 65105-3300, phone 573-751-2836.

0769501

MISSOURI PROJECT EXEMPTION CERTIFICATE

Authorization for Purchasing Construction Materials for Tax Exempt Project
(The Form and Content of this Exemption Certificate have been approved by the Missouri Department of Revenue)

EXEMPT ENTITY ISSUING CERTIFICATE

Name: City of Republic, Missouri
Address: 213 N. Main Avenue
City/State/Zip: Republic, Missouri 65738

MO Tax Exempt I.D. #: 12492990

Letter Effective Date:

Contract Date:

Certificate Expiration Date:

Contract #: _____

Revised Expiration Date: _____

Project Description: Republic Aquatic Center – Flowrider Refurbishment

Project Location: 711 E. Miller Rd. Republic, Missouri

Estimated Project Completion Date: April 30, 2019

Auth. Signature: _____, Mayor Jeff Ussery Date: _____

The Missouri exempt entity named above hereby authorizes the purchase, without sales tax, of tangible personal property to be incorporated or consumed in the construction of the project identified herein and no other, pursuant to Section 144.62 RSMo.

PURCHASING CONTRACTOR OR SUBCONTRACTOR

Name:
Address:
City/State/Zip:

INSTRUCTIONS

EXEMPT ENTITY - A signed copy of this certificate, along with your MO Tax Exemption Letter, must be furnished to each contractor and/or subcontractor who will be purchasing tangible personal property for use in the project. It is the exempt entity’s responsibility to ensure the validity of the certificate. You must issue a certificate with a Revised Expiration Date if purchases will be required to complete the project beyond the original Project Exemption Date.

CONTRACTOR OR SUBCONTRACTOR - The contractor shall furnish a completed copy of this exemption certificate, along with a copy of the exempt entity’s MO Tax Exemption Letter, to all subcontractors, and any contractor or subcontractor purchasing materials shall present copies of such documents to all material suppliers as authorization to purchase, on behalf of the exempt entity, all tangible personal property and materials to be incorporated or consumed in the construction of that project and no other on a tax-exempt basis. A copy of each certificate must be retained by the purchaser for a period of five years.

MATERIAL SUPPLIER - A completed copy of this exemption certificate, along with the MO Tax Exemption Letter of the exempt entity contracting for the project, must be obtained from the contractor or subcontractor making purchases of tangible personal property for use in the project, and retained for audit purposes. Invoices issued for such purchases must reflect the name of the exempt entity and the project number assigned by the exempt entity shown above.

**NOTICE AND INSTRUCTIONS TO CONTRACTORS/SUBCONTRACTORS
REGARDING SECTIONS 285.525 THROUGH 285.550 RSMO, EFFECTIVE JANUARY 1, 2009**

Effective January 1, 2009, and pursuant to the State of Missouri's RSMO 285.530(1), No business entity or employer shall knowingly employ, hire for employment, or continue to employ an unauthorized alien to perform work within the State of Missouri.

As a condition for the award of any contract or grant in excess of five thousand dollars by the state or by any political subdivision of the state (e.g., City of Republic, MO) to a business entity, the business entity (Company) shall, by sworn affidavit and provision of documentation, affirm its enrollment and participation in a federal work authorization program with respect to the employees working in connection with the contracted services. Every such business entity shall sign an affidavit affirming that it does not knowingly employ any person who is an unauthorized alien in connection with the contracted services. [RSMO 285-530(2)]

The City of Republic, Missouri, in order to comply with sections 285.525 through 285.550 RSMO, requires the following Bid and contract documents:

Required Affidavit for Contracts Over \$5,000.00 (US) – Effective 1-1-2009, Company shall comply with the provisions of Section 285.525 through 285.550 R.S.Mo. Contract award is contingent on Company providing an acceptable notarized affidavit stating:

1. that Company is enrolled in and participates in a federal work authorization program with respect to the employees working in connection with the contracted services; and
2. that Company does not knowingly employ any person who is an unauthorized alien in connection with the contracted services.

Copies of affidavit can be found and downloaded on the City of Republic Missouri Public Works website;

The City of Republic encourages companies that are not enrolled and participating in a federal work authorization program to do so. E-Verify is an example of this type of program. Information regarding E-Verify is available at http://www.dhs.gov/xprevprot/programs/gc_1185221678150.shtm or by calling **888-464-4218**.

**AFFIDAVIT OF COMPLIANCE WITH SECTION 285.500 R.S.MO., ET SEQ.
FOR ALL AGREEMENTS IN EXCESS OF \$5,000.00**

EFFECTIVE 1/1/2009

STATE OF _____)
) ss.
COUNTY OF _____)

Before me, the undersigned Notary Public, in and for the County of _____,
State of _____, personally appeared _____ (Name)
who is _____ (Title) of _____
(Name of company), (corporation), (partnership), (sole proprietorship), (limited liability company), and after being duly
sworn did depose and say:

- (1) that said company is enrolled in and participates in a federal work authorization program with respect to the employees working in connection with the contracted services; and
- (2) that said company does not knowingly employ any person who is an unauthorized alien in connection with the contracted services.

The terms used in this affidavit shall have the meaning set forth in Section 285.500 R.S. Mo., et seq.

Documentation of participation in a federal work authorization program is attached to this affidavit.

Signature

Printed Name

Subscribed and sworn to before me this _____ day of _____, _____.

Notary Public

My commission expires: _____

Company ID Number: XXXXXX

The foregoing constitutes the full agreement on this subject between the SSA, DHS (Department of Homeland Security), and the Employer.

The individuals whose signatures appear below represent that they are authorized to enter into this MOU on behalf of the Employer and DHS respectively.

To be accepted as a participant in E-Verify, you should only sign the Employer's Section of the signature page. If you have any questions, contact E-Verify Operations at 888-464-4218.

Employer, Your Company Name

John Doe
Name (Please type or print)

Title

Electronically Signed
Signature

Date

Verification

Department of Homeland Security Division

USCIS Verification Division
Name (Please type or print)

Title

Electronically Signed
Signature

Date

Sample
E-Verify
Memo of
Understanding - MOU
Electronic Signature
Page



ADDENDUM #01

RE: **Pavement for Animal Control Center Parking lot and Driveway**

To Whom It May Concern:

The purpose of this addendum is to inform you that the City of Republic is requesting an additional alternative bid for a larger portion of paved area than described in the original Invitation for Bid, approximately 13,107 SF of asphalt or concrete pavement. bidders are asked to submit a bid for both:

A) Approximately 7869 square feet of concrete or asphalt parking and driveway for Animal control center including 6 in. curb & gutter on both sides of the driveway from 1 ft behind storm pipe to edge of right-of-way (ROW), approximately 103 linear feet. Pavement in ROW shall be 8in bituminous asphalt, 8 in concrete, or 7 in reinforced concrete. all sub grade preparation will be completed by the city prior to contractor work beginning. See attached plans for details

And,

B) Approximately 13,107 square feet of concrete or asphalt parking and driveway for Animal control center including 6 in. curb & gutter on both sides of the driveway from 1 ft behind storm pipe to edge of right-of-way (ROW), approximately 103 linear feet. Pavement in ROW shall be 8in bituminous asphalt, 8 in concrete, or 7 in reinforced concrete. all sub grade preparation will be completed by the city prior to contractor work beginning. See attached plans for details

If a bidder submits for only one of these alternatives they may or may not be selected if they do not submit for the alternative the City of Republic chooses to move forward with. Bid opening will remain **Thursday, July 2, 2020 3:00pm** as stated on the advertisement. All other conditions of the bid shall remain the same.

Garrett Brickner

Assistant Community Development & Public Works Director

City of Republic

204 N. Main St. Republic, MO 65738

Phone: (417) 732-3405

Mission: "We will be aggressively progressive through *Processes, Relationships, and Trust*"

Unit Price Curb + gutter # .25.24 per linear ft.
Asphalt Paving # 1.95 per sq. ft. with Others preparing for paving
 includes haying + furnish 3" in depth After compa Except 8" in Right Away
 Item 9.

ATTACHMENT A - BID SUBMISSION FORM

Exhibit B

BIDDERS MUST PROVIDE THE FOLLOWING INFORMATION:

Item	Description of Work	Price
Base Bid	<p>BASE Bid</p> <ul style="list-style-type: none"> Furnishing and installation of all materials and labor for Pavement for Animal Control Center Parking lot and driveway <i>City prepares sub-grade compacted - ready for PAVING</i> All bids to include: <ul style="list-style-type: none"> Travel Expenses Freight/Shipping Costs Any other administrative costs All work must be completed by August 1st, 2020 <p>Please note any of the following:</p> <ul style="list-style-type: none"> Any labor personnel requests of the City of Republic for this project. Any other requests or responsibilities of the City of Republic for this project. <p><i>City will prepare all areas for paving. Includes grading, drainage + Base Rock - compacted for paving</i></p> <p><i>Alternate Bid</i></p>	<p>BASE Bid</p> <p>#26,685</p> <p>Includes concrete curb + gutter + Asphalt ROW 20x60 8" Asphalt Remainder 3" Asphalt</p> <p>Alternate #1 Bid</p> <p>#28,744</p> <p>Includes curb/gutter + Asphalt ROW 20x60 8" Asphalt Remainder 3" Asphalt</p>

In compliance with this invitation for Bid and to all terms, conditions, and specifications imposed therein and hereby incorporated by reference, the undersigned offers and agrees to furnish the goods and/or services described herein.

City of Republic - Pavement for Animal Control Center Parking lot and driveway 312 N Main St., Republic, MO 65738	Company Legal Name:
	 American Paving Co. Inc. 354 S. Wren Rogersville, MO 65742
	Address:
Telephone: 417-425-4915	<i>John Killingsworth</i>
Facsimile: N/A	Signed Dated July 2, 2020
E-mail: americanpaving@att.net	Printed Title John Killingsworth
Cellular: 417-425-4915 John	Bidders Federal ID Number: 47-0859396
417-425-9907 Andy	

To be submitted with Vendor's Bid (MUST BE COMPLETED)

X We DO NOT take exception to the IFB Documents/Requirements.

 We TAKE exception to the IFB Documents/Requirements as follows (MUST SPECIFY EXCEPTIONS):

CITY OF REPUBLIC STATEMENT OF "NO BID" * ADDENDA

Bidder acknowledges receipt of the following addendum:

RETURN THIS PAGE ONLY IF YOUR COMPANY PROVIDES THE PRODUCTS/SERVICES BEING BID AND DECLINES TO DO SO.

Addendum No. 1

Addendum No.

WE, THE UNDERSIGNED, HAVE DECLINED TO BID ON YOUR IFB * FOR DESCRIPTION FOR THE FOLLOWING REASON(S):

Addendum No.

 SPECIFICATIONS ARE TOO "TIGHT," I.E. GEARED TOWARD ONE BRAND OR MANUFACTURER ONLY (PLEASE EXPLAIN BELOW).

Addendum No.

Addendum No.

 INSUFFICIENT TIME TO RESPOND TO INVITATION FOR BID.

 OUR PRODUCT SCHEDULE WOULD NOT PERMIT US TO PREFORM.

Print Email americanpaving@att.net

Print Federal Tax ID No. 47-0859396

GENERAL NOTES:

1. CONSTRUCTION METHODS AND MATERIALS SHALL CONFORM TO THE LATEST REVISIONS OF THE STANDARD GENERAL CONDITIONS AND TECHNICAL SPECIFICATIONS FOR CONSTRUCTION FOR THE CITY OF REPUBLIC, GREENE COUNTY, MISSOURI, DATED JANUARY 8, 2015.
2. THE CONTRACTOR SHALL FIELD VERIFY ALL HORIZONTAL AND VERTICAL LINES AND GRADES OF EXISTING UTILITIES PRIOR TO THE CONSTRUCTION OF IMPROVEMENTS. THE CONTRACTOR SHALL NOTIFY THE ENGINEER IMMEDIATELY UPON DISCOVERY OF A DISCREPANCY BETWEEN THE CONSTRUCTION PLANS AND ACTUAL FIELD CONDITIONS.
3. NOTIFY THE CITY OF REPUBLIC INSPECTION AT 732-3354 AT LEAST 48 HOURS PRIOR TO CONSTRUCTION. FAILURE TO DO SO MAY CAUSE ANY OR ALL CONSTRUCTION TO BE REJECTED.
4. APPLICABLE PERMITS MUST BE OBTAINED FROM THE CITY, STATE, AND COUNTY PRIOR TO EXCAVATION WITHIN ANY RIGHT-OF-WAY, AND PRIOR TO ANY CONSTRUCTION.
5. IT SHALL BE THE CONTRACTOR'S RESPONSIBILITY TO DETERMINE THE LOCATION OF ANY UNDERGROUND UTILITIES OR OTHER OBSTRUCTIONS AND TO BE LIABLE FOR DAMAGE AND CONSEQUENT REPAIR TO SUCH IN THE COURSE OF HIS OPERATIONS.
6. ALL DISTURBED AREAS ARE TO BE RESEDED IN ACCORDANCE WITH THE CONSTRUCTION SPECIFICATIONS FOR THE CITY OF REPUBLIC, GREENE COUNTY, MISSOURI.
7. SIDEWALKS, HANDICAP RAMPS, UTILITIES, STORM WATER, AND SANITARY SEWER SHALL BE CONSTRUCTED IN ACCORDANCE TO THE "CONSTRUCTION SPECIFICATIONS FOR PUBLIC IMPROVEMENTS" FOR THE CITY OF REPUBLIC AND CURRENT ADA SPECIFICATIONS
8. THE SITE DOES NOT LIE IN 100-YEAR FLOOD PLAIN AS PER COMMUNITY PANEL NO. 29077C 0426E, DATED DECEMBER 17TH, 2010.
9. THE CONTRACTOR WILL BE RESPONSIBLE TO NOTIFY THE ENGINEER WHEN DIFFERENCES IN FIELD CONDITION AND PLANS OCCUR. ADJUSTMENT MADE IN THE FIELD WITHOUT PRIOR APPROVAL OF THE ENGINEER MAY RESULT IN UNPAID CONSTRUCTION ACTIVITY.

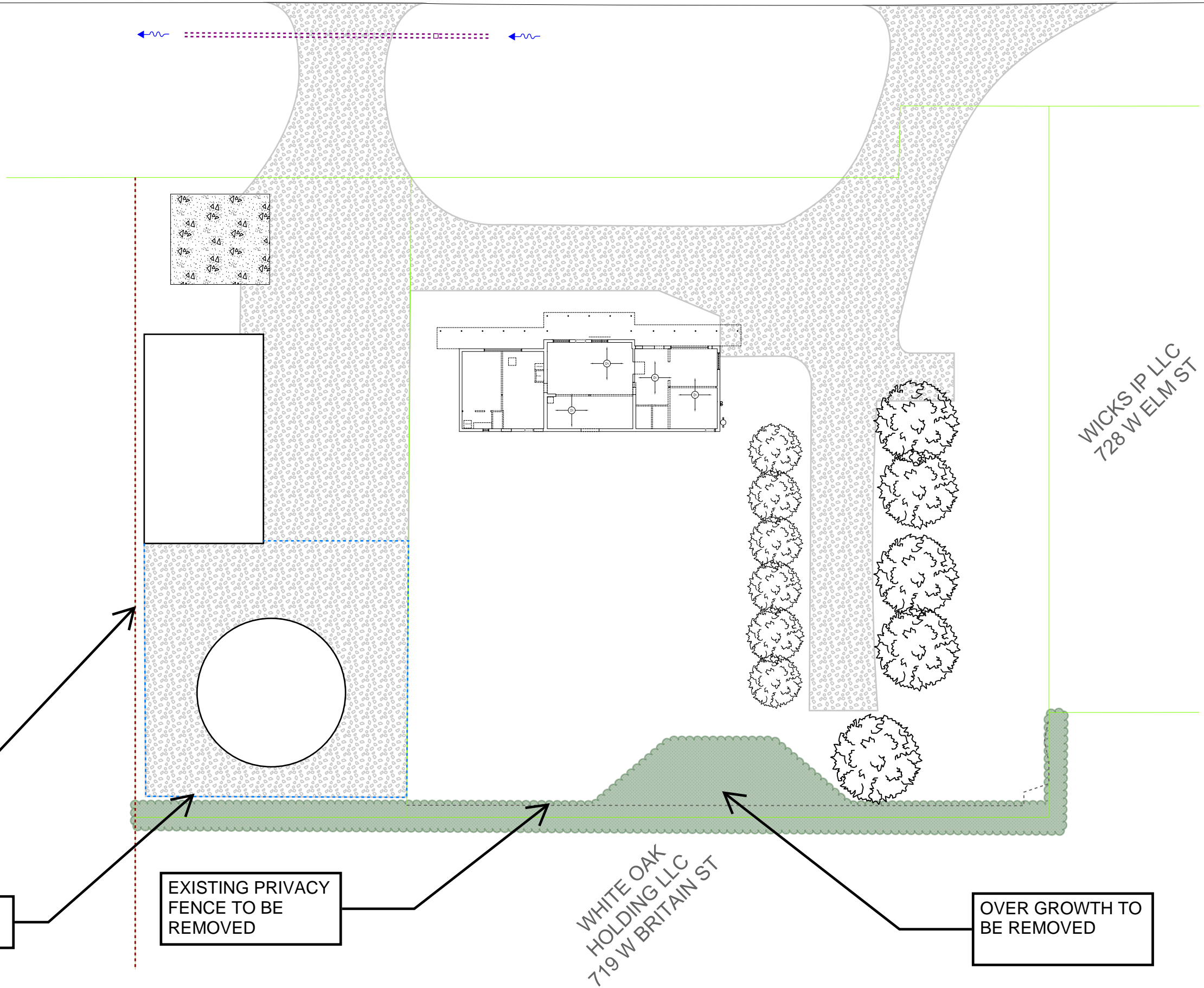

DATE 5/15/2020	
SHEET NO.	SHEETS
ROUTE	
JOB NO.	
CONTRACT ID	
PROJECT NO.	
REV 2	
DRAWN BY:	

DATE	DESCRIPTION
-	-
-	-
-	-
-	-

REPUBLIC ANIMAL
CONTROL SITE PLAN

DESCRIPTION

DATE

REPUBLIC ANIMAL CONTROL SITE PLAN

REPUBLIC
MISSOURI
GROWING TOGETHER

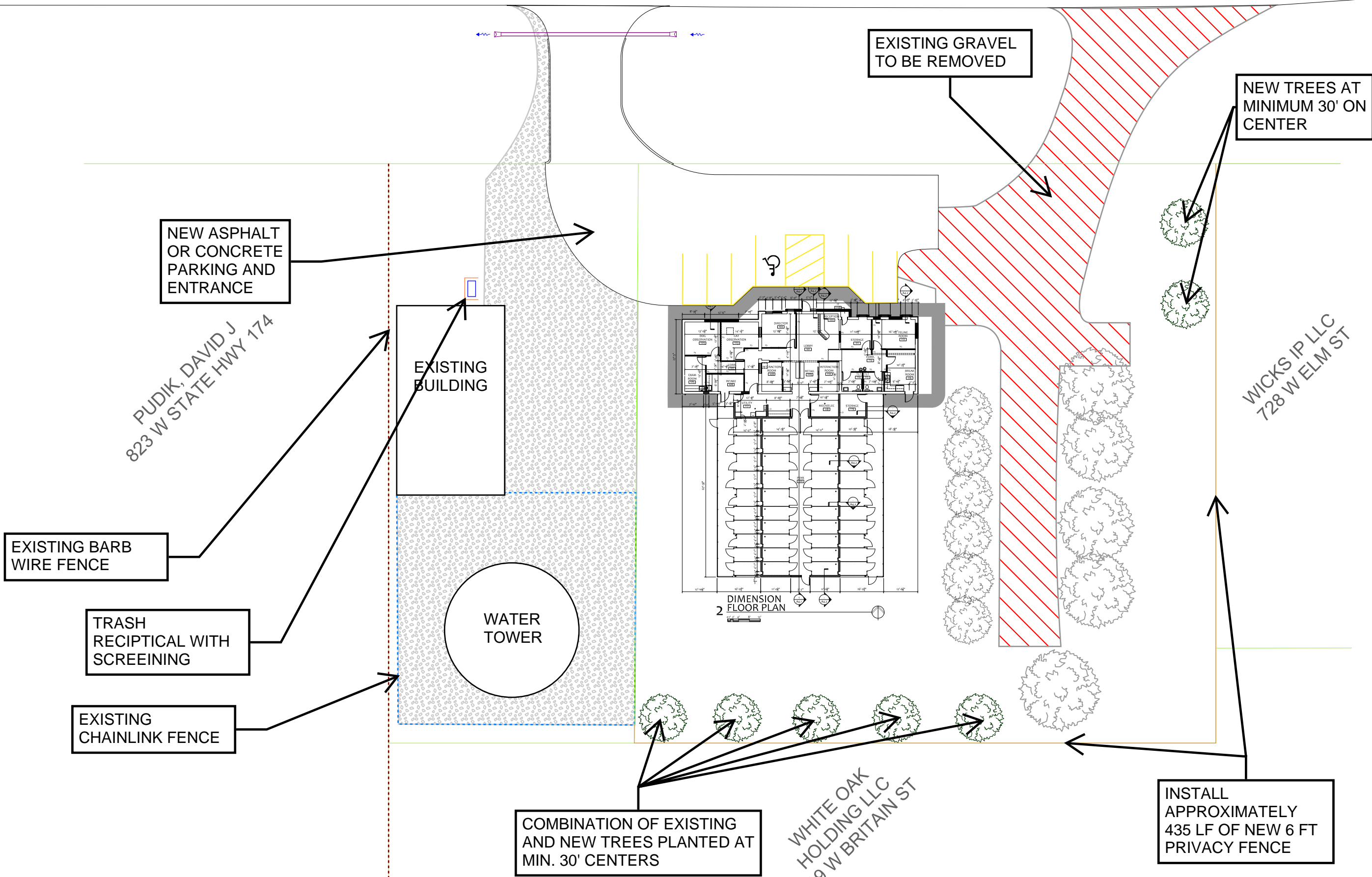

NEW ASPHALT OR CONCRETE PARKING AND ENTRANCE

PUDIJK, DAVID J
823 W STATE HWY 174

EXISTING BUILDING

EXISTING GRAVEL TO BE REMOVED

NEW TREES AT MINIMUM 30' ON CENTER

EXISTING BARB WIRE FENCE

TRASH RECIPTICAL WITH SCREENING

EXISTING CHAINLINK FENCE

WATER TOWER

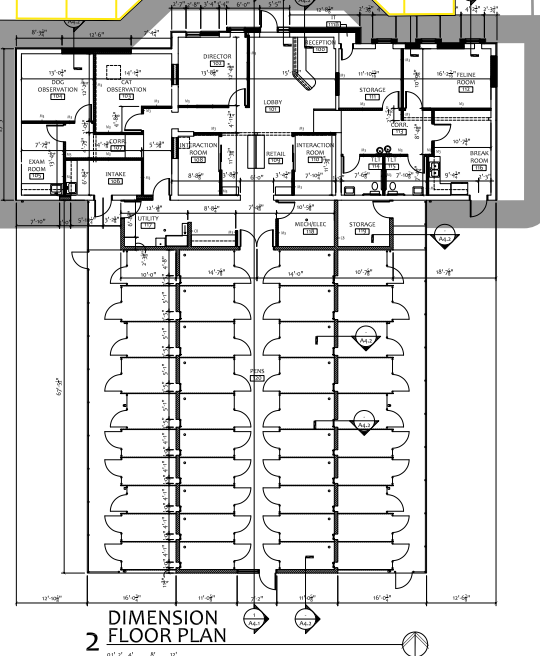

COMBINATION OF EXISTING AND NEW TREES PLANTED AT MIN. 30' CENTERS

WHITE OAK HOLDING LLC
719 W BRITAIN ST

INSTALL APPROXIMATELY 435 LF OF NEW 6 FT PRIVACY FENCE

WICKS IP LLC
728 W ELM ST

DATE	5/15/2020
SHEET NO.	SHEETS
ROUTE	-
JOB NO.	-
CONTRACT ID	-
PROJECT NO.	-
REV	2
DRAWN BY:	-

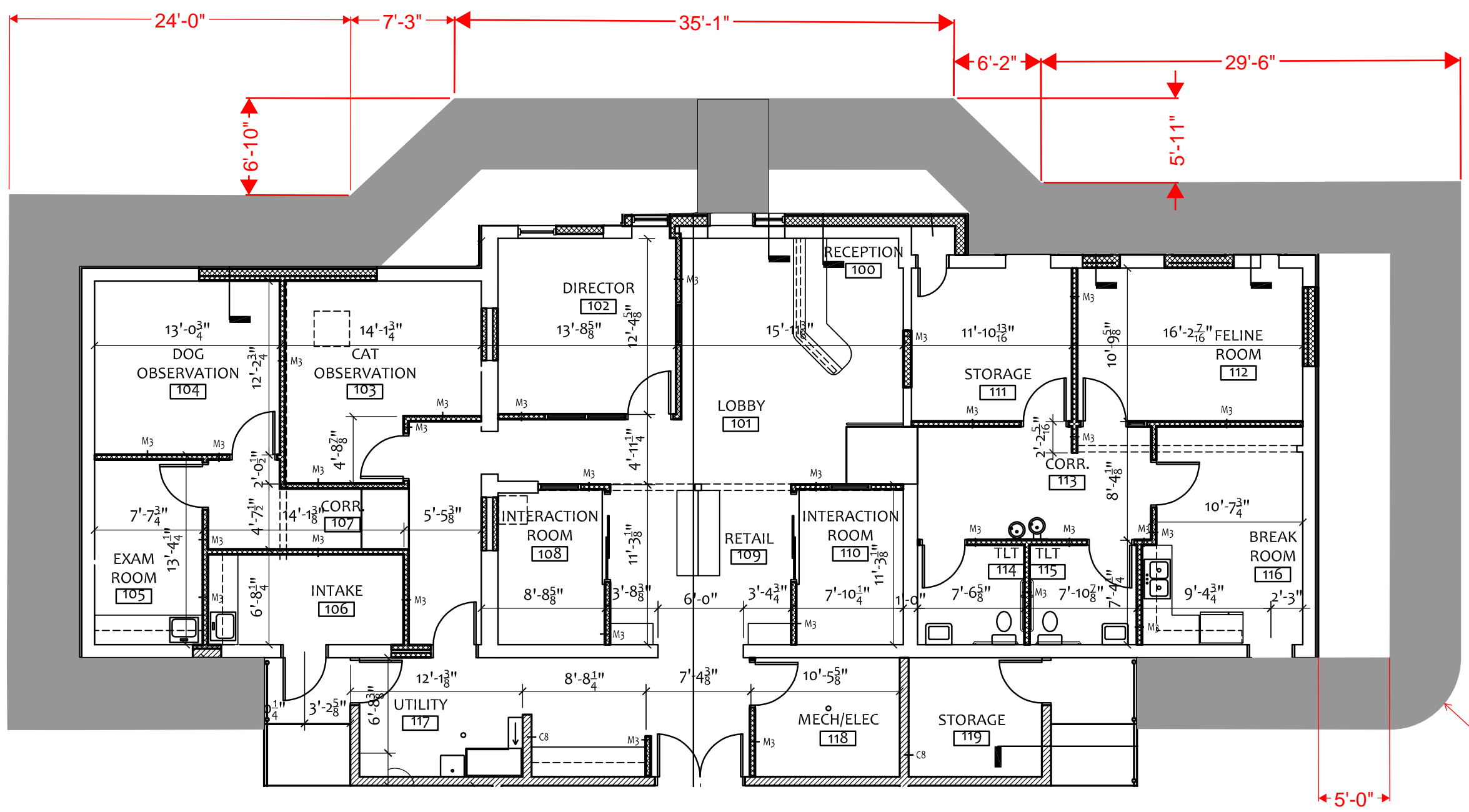

DATE	DESCRIPTION
-	-
-	-
-	-
-	-

REPUBLIC ANIMAL CONTROL SITE PLAN

1. APPROXIMATELY 1005 SF OF 4 IN SIDEWALK
2. SIDEWALK WIDTH IS 5FT UNLESS OTHERWISE INDICATED
3. MAINTAIN MIN. 5 FT WIDTH ON ALL SIDEWALK
4. SEE CITY OF REPUBLIC SPECIFICATIONS FOR CURB RAMP DETAIL

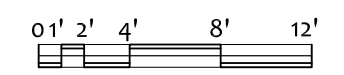

RADIUS OPTION FOR CONCRETE CORNERS

W STATE HIGHWAY 174

Item 9.

DATE	5/15/2020
SHEET NO.	SHEETS
ROUTE	-
JOB NO.	-
CONTRACT ID	-
PROJECT NO.	-
REV	2
DRAWN BY:	-

1. APPROXIMATELY 7869 SF PARKING & DRIVEWAY
2. CITY TO REPLACE EXISTING CULVERT UNDER DRIVEWAY WITH EQUAL OR GREATER DIAMETER CMP OR RCP.
3. GRADE DITCH TO DRAIN TO THE EAST MIN. 2% SLOPE
4. (6) PARKING SPACES REQUIRED - TYPICALLY 9X19 WITH (1) HANDICAP SPACE 11X19
5. APPROXIMATELY 103 LF OF CURB & GUTTER
6. SEE MODOT CURB DETAIL ON PG. 5

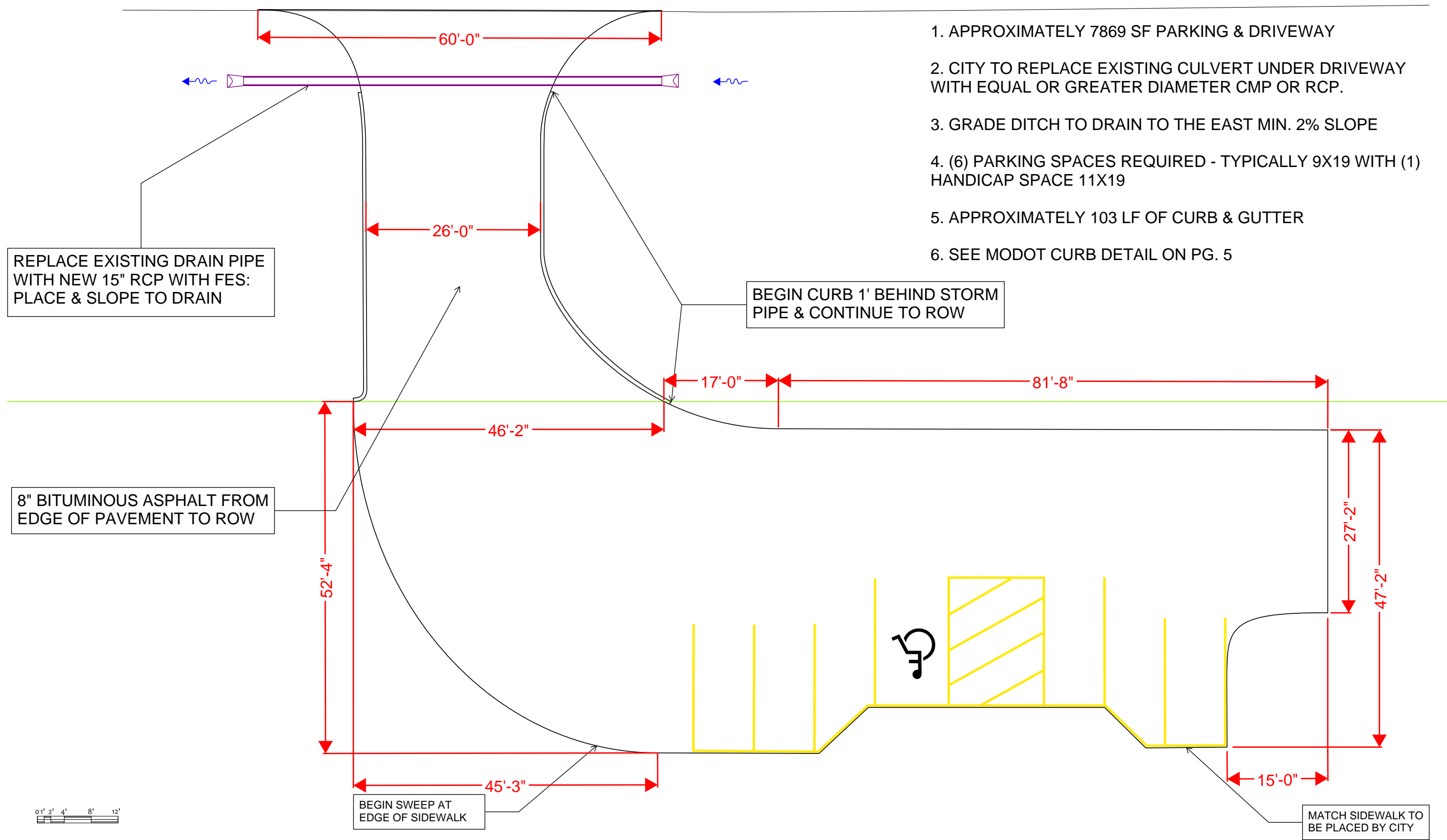

DATE	DESCRIPTION
-	-
-	-
-	-
-	-

REPUBLIC ANIMAL CONTROL SITE PLAN



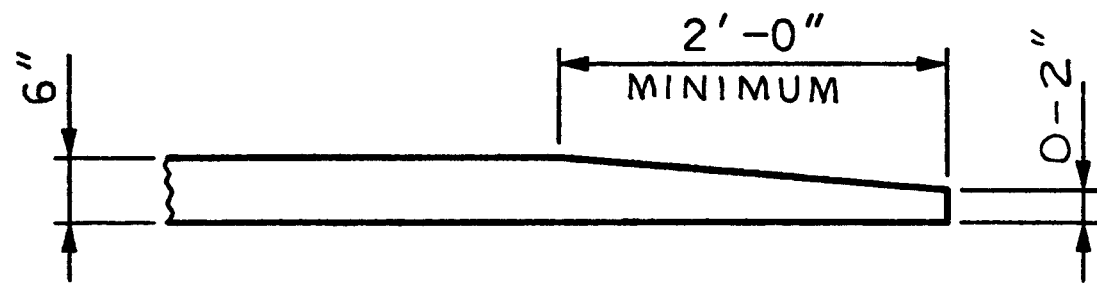

CURB TERMINUS DETAIL

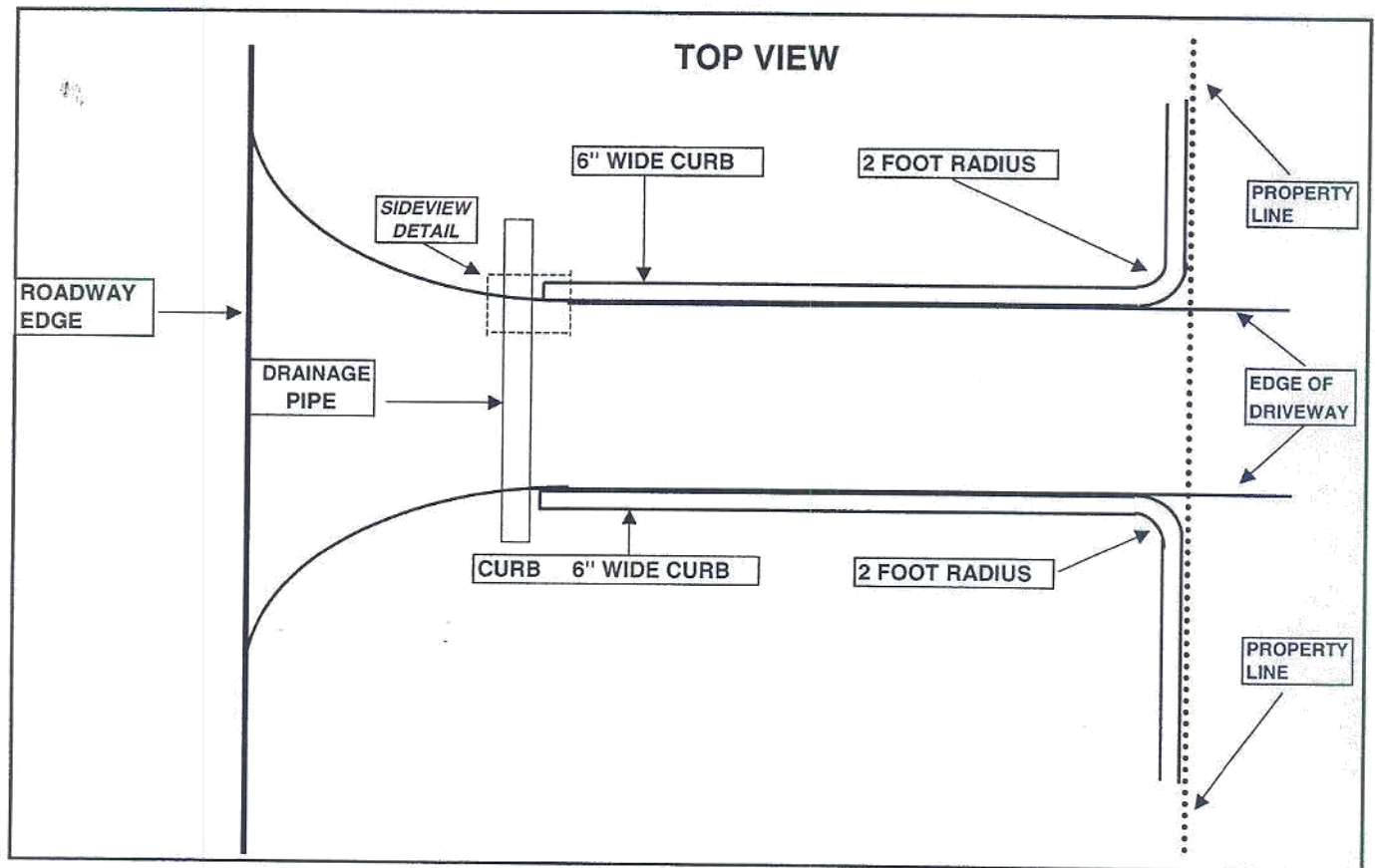
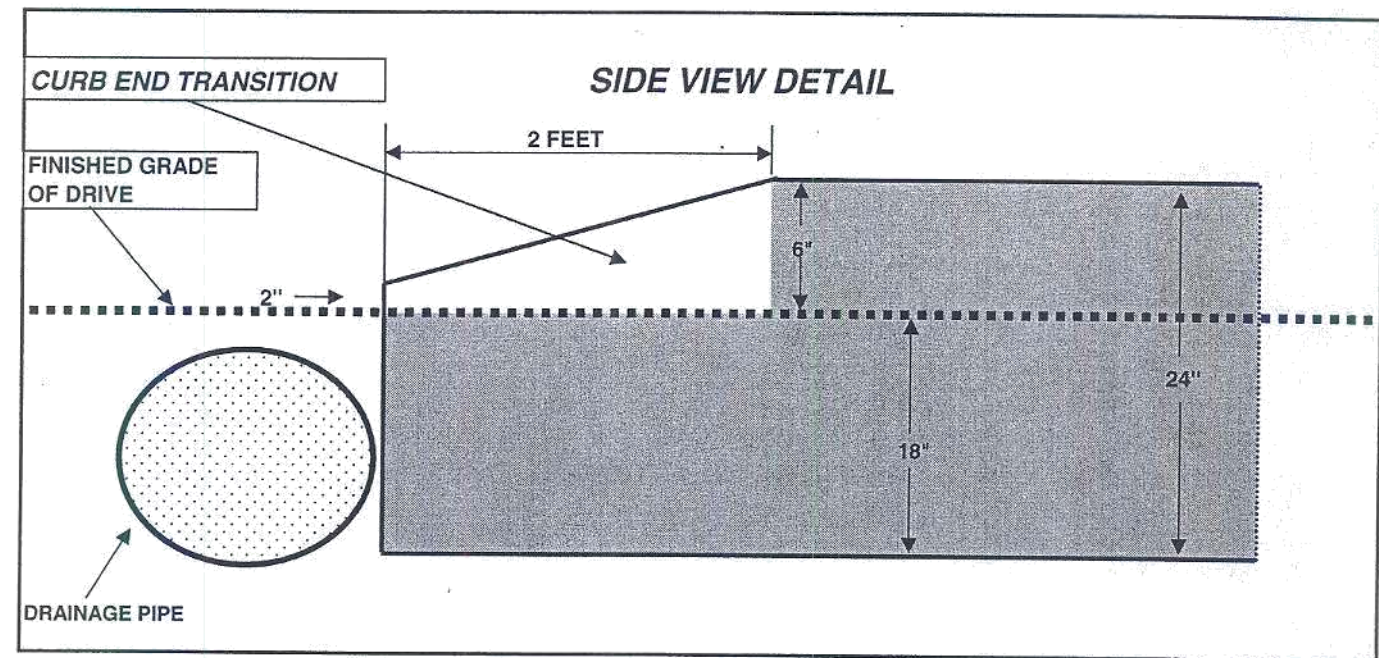

DATE	
SHEET NO.	SHEETS
ROUTE	
JOB NO.	
CONTRACT ID	
PROJECT NO.	
REV 2	
DRAWN BY:	

DATE	DESCRIPTION
-	-
-	-
-	-
-	-

REPUBLIC ANIMAL CONTROL SITE PLAN

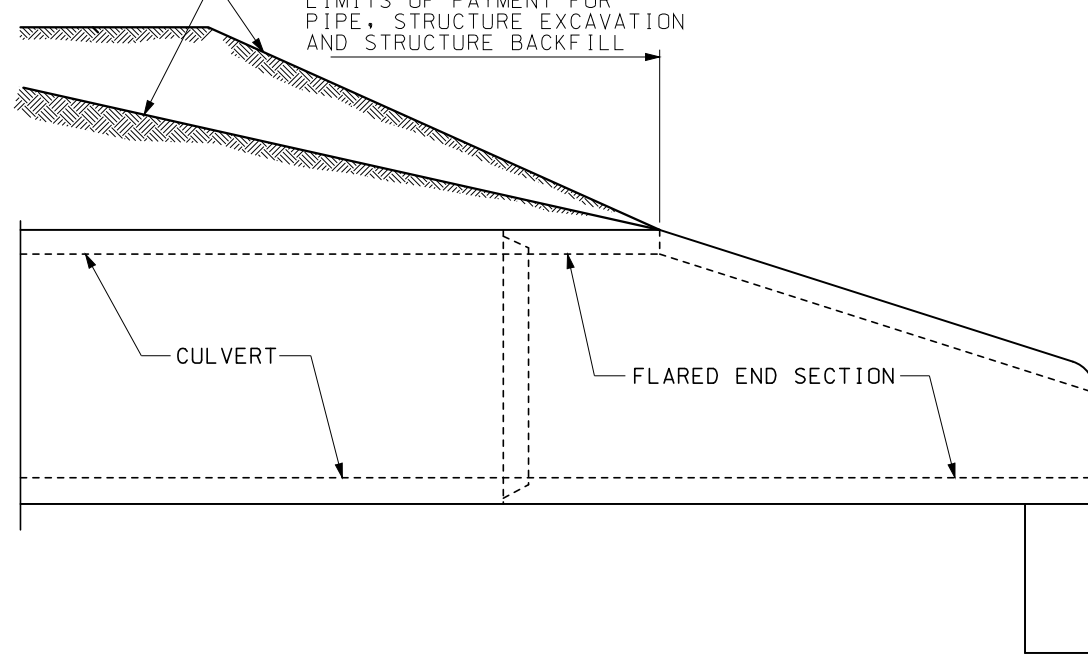
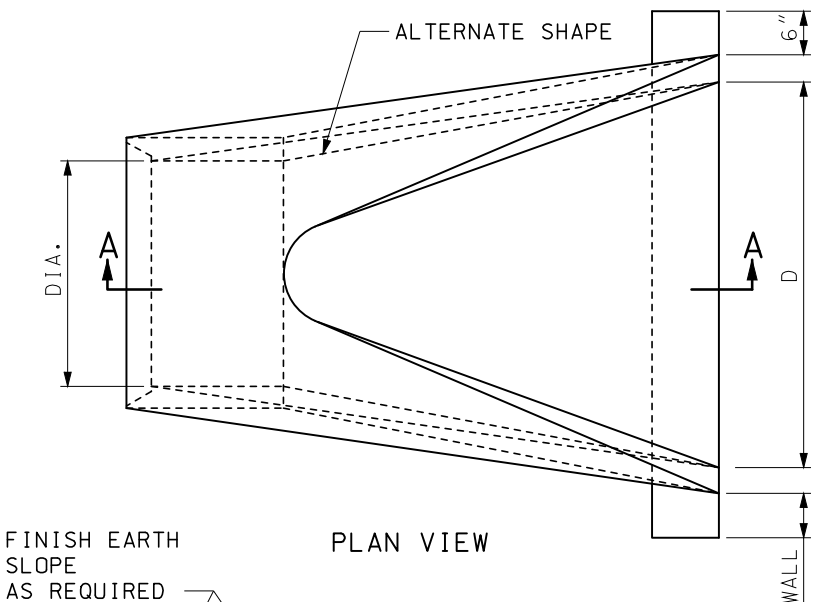
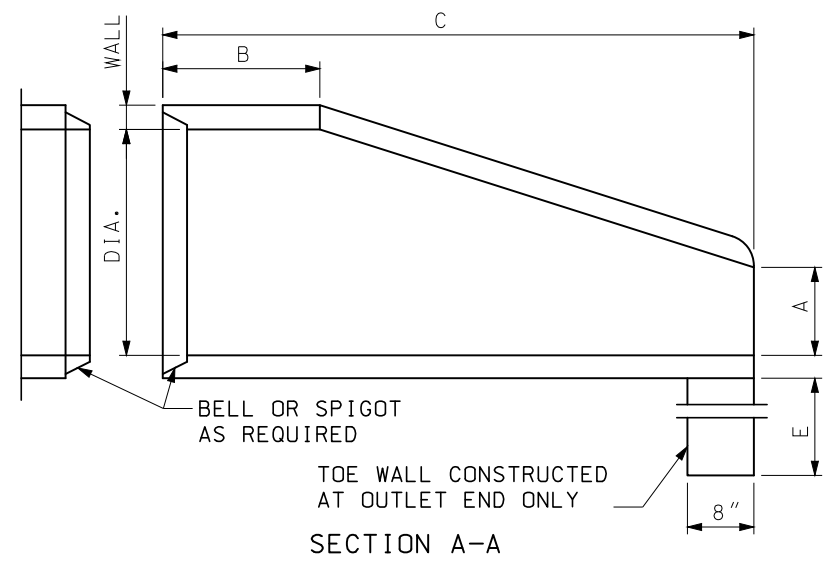

INSTALLATION DETAILS

DIMENSIONS						
DIA.	WALL	A	B MIN.	C MIN.	D	E
12"	2"	4"	4'-0"	6'	2'-0"	18"
15"	2 1/4"	6"	3'-10"	6'	2'-6"	18"
18"	2 1/2"	9"	3'-10"	6'	3'-0"	18"
21"	2 3/4"	9"	3'-2"	6'	3'-6"	18"
24"	3"	9 1/2"	2'-6"	6'	4'-0"	24"
27"	3 1/4"	10 1/2"	2'-1"	6'	4'-6"	24"
30"	3 1/2"	1'-0"	1'-7"	6'	5'-0"	24"
33"	3 3/4"	1'-2"	1'-7"	6'	5'-6"	24"
36"	4"	1'-3"	2'-10"	8'	6'-0"	24"
42"	4 1/2"	1'-9"	2'-11"	8'	6'-6"	24"
48"	5"	2'-0"	2'-2"	8'	7'-0"	24"
54"	5 1/2"	2'-3"	2'-11"	8'	7'-6"	36"
60"	6"	2'-6"	3'-3"	8'	8'-0"	36"
66"	6 1/2"	2'-0"	1'-9"	8'	8'-6"	36"
72"	7"	2'-0"	2'-9"	10'	9'-0"	36"
78"	7 1/2"	2'-3"	2'-3"	10'	9'-6"	36"
84"	8"	2'-6"	2'-0"	10'	10'-0"	36"

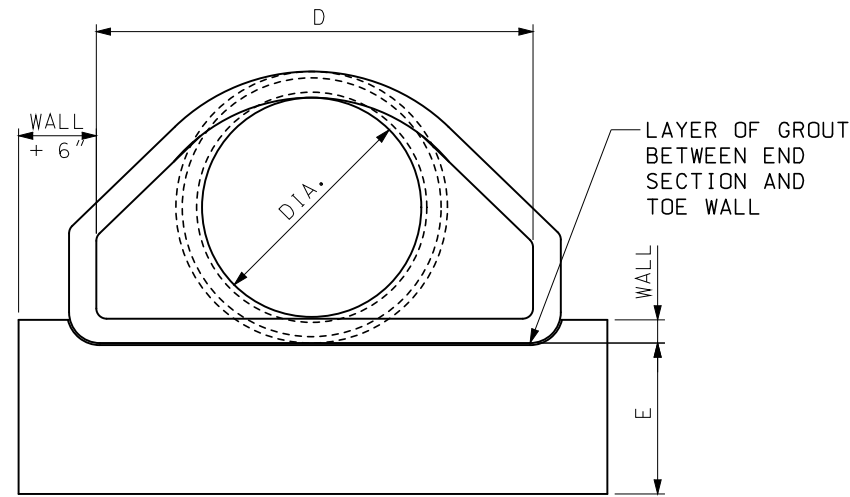

END VIEW

ADJOINING PIPE DIA.	REINFORCEMENT				
	BARREL SECTION REINFORCEMENT			FLARE SECTION REINFORCEMENT (ONE LAYER ONLY IN CENTER OF WALL)	
	CIRCULAR		ELLIPTICAL		
	INNER CAGE SQ. IN./LIN. FT.	OUTER CAGE SQ. IN./LIN. FT.	SQ. IN./LIN. FT.	AREA OF LONGITUDINAL SQ. IN./LIN. FT.	AREA OF TRANSVERSE SQ. IN./LIN. FT.
12"	0.07			0.048	0.048
15"	0.07			0.054	0.054
18"	0.07		0.07	0.060	0.060
21"	0.07		0.07	0.066	0.066
24"	0.07		0.07	0.072	0.072
27"	0.13		0.11	0.078	0.078
30"	0.14		0.12	0.084	0.084
33"	0.15		0.13	0.090	0.090
36"	0.12	0.09	0.13	0.096	0.096
42"	0.15	0.12	0.17	0.108	0.108
48"	0.18	0.14	0.20	0.120	0.120
54"	0.22	0.16	0.24	0.132	0.132
60"	0.25	0.19	0.28	0.144	0.144
66"	0.31	0.23	0.34	0.156	0.156
72"	0.35	0.21	0.39	0.170	0.170
78"	0.40	0.24	0.44	0.185	0.185
84"	0.46	0.28	0.51	0.205	0.205

GENERAL NOTES:

SLIGHT VARIATIONS IN BOTH SHAPE AND DIMENSIONS FROM THOSE SHOWN MAY BE ACCEPTED IF APPROVED BY THE ENGINEER.

NOT MORE THAN THREE LIFT HOLES MAY BE DRILLED OR CAST IN THE END SECTION FOR HANDLING AND LAYING.

LIFT LUGS OR BARS WILL BE PERMITTED IN PRECAST TOE WALLS.

TOE WALLS MAY BE CAST-IN-PLACE OR PRECAST.

STEEL FIBERS MAY BE USED IN LIEU OF REBAR OR COLD DRAWN STEEL WIRE AS PER SECTION 1032.3.4.

MISSOURI HIGHWAYS AND TRANSPORTATION COMMISSION

105 WEST CAPITOL
JEFFERSON CITY, MO 65102
1-888-ASK-MODOT (1-888-275-6636)

FLARED END SECTION

PRECAST CONCRETE

STATE OF MISSOURI
ERIC E. SCHROETER
NUMBER PE-28411
PROFESSIONAL ENGINEER

THIS SHEET HAS BEEN SIGNED, SEALED AND DATED ELECTRONICALLY.

DATE EFFECTIVE: 04/01/2016
DATE PREPARED: 2/11/2016

732.00S

SHEET NO.
1 OF 3

IF A SEAL IS PRESENT ON THIS SHEET IT HAS BEEN ELECTRONICALLY SEALED AND

ATTACHMENT A - BID SUBMISSION FORM

BIDDERS MUST PROVIDE THE FOLLOWING INFORMATION:

Item	Description of Work	Price
<p>Base Bid</p>	<ul style="list-style-type: none"> • Furnishing and installation of all materials and labor for Pavement for Animal Control Center Parking lot and driveway • All bids to include: <ul style="list-style-type: none"> ○ Travel Expenses ○ Freight/Shipping Costs ○ Any other administrative costs • All work must be completed by August 1st, 2020 <p>Please note any of the following:</p> <ul style="list-style-type: none"> • Any labor personnel requests of the City of Republic for this project. • Any other requests or responsibilities of the City of Republic for this project. 	<p>\$ _____</p>

In compliance with this Invitation for Bid and to all terms, conditions, and specifications imposed therein and hereby incorporated by reference, the undersigned offers and agrees to furnish the goods and/or services described herein.

<p>City of Republic – Perimeter Fencing and Kennel Barriers for the Animal Control Center</p> <p>312 N Main St., Republic, MO 65738</p>	
	<p>Company Legal Name:</p>
<p>Telephone:</p>	
<p>Facsimile:</p>	<p>Address:</p>
<p>E-mail:</p>	<p>Signed Dated</p>
<p>Cellular:</p>	<p>Printed Title</p>
	<p>Bidders Federal ID Number:</p>



ADDENDUM #01

RE: Pavement for Animal Control Center Parking lot and Driveway

To Whom It May Concern:

The purpose of this addendum is to inform you that the City of Republic is requesting an additional alternative bid for a larger portion of paved area than described in the original Invitation for Bid, approximately 13,107 SF of asphalt or concrete pavement. bidders are asked to submit a bid for both:

A) Approximately 7869 square feet of concrete or asphalt parking and driveway for Animal control center including 6 in. curb & gutter on both sides of the driveway from 1 ft behind storm pipe to edge of right-of-way (ROW), approximately 103 linear feet. Pavement in ROW shall be 8in bituminous asphalt, 8 in concrete, or 7 in reinforced concrete. all sub grade preparation will be completed by the city prior to contractor work beginning. See attached plans for details

And,

B) Approximately 13,107 square feet of concrete or asphalt parking and driveway for Animal control center including 6 in. curb & gutter on both sides of the driveway from 1 ft behind storm pipe to edge of right-of-way (ROW), approximately 103 linear feet. Pavement in ROW shall be 8in bituminous asphalt, 8 in concrete, or 7 in reinforced concrete. all sub grade preparation will be completed by the city prior to contractor work beginning. See attached plans for details

If a bidder submits for only one of these alternatives they may or may not be selected if they do not submit for the alternative the City of Republic chooses to move forward with. Bid opening will remain **Thursday, July 2, 2020 3:00pm** as stated on the advertisement. All other conditions of the bid shall remain the same.

Garrett Brickner

Assistant Community Development & Public Works Director

City of Republic

204 N. Main St. Republic, MO 65738

Phone: (417) 732-3405

Mission: "We will be aggressively progressive through *Processes, Relationships, and Trust*"

NOTICE OF AWARD

DATED: _____

TO: American Paving Co. Inc.
354 S. Wren
Rogersville, Missouri, 65742

PROJECT: Republic Animal Shelter – Pavement of parking lot and driveway

DESCRIPTION OF WORK: As described in the Agreement.

You are notified that your Bid dated July 2, 2020, for the above Agreement has been considered. You are the successful bidder and have been awarded an Agreement for the work in the Agreement.

The Agreement price, based on the submitted unit pricing of your bid is \$28,744.00, with any contingency allowance set aside as specified in the Agreement.

Two copies of each of the proposed Agreement Documents accompany this Notice of Award. You must comply with the following conditions within ten business days of the date of this Notice of Award, that is by _____.

1. You must deliver to the City two fully executed counterparts of the Agreement including all the Agreement Documents. Each of the Agreement Documents must bear your signature on the cover sheet. The date on the Agreement must be left blank and will be filled in by the City.
2. You must deliver with the executed certificates of Insurance as specified in the Agreement.

Within 10 days after you comply with these conditions, the City will return to you two fully signed counterparts of the Agreement with the Agreement Documents attached.

You are required to return an acknowledged copy of this Notice of Award to the City.

_____, _____ Director

ACCEPTANCE OF NOTICE

Receipt of the foregoing Notice of Award is hereby acknowledged and the following Performance Schedule is submitted pursuant to the terms of the Bid and Contractor Agreement, this _____ day of _____, 20____.

By _____

Title _____

NOTICE TO PROCEED

DATED: _____

TO:

American Paving Co. Inc.
354 S. Wren
Rogersville, Missouri, 65742

PROJECT/DESCRIPTION OF WORK: Republic Animal Shelter – Pavement of parking lot and driveway

CONTRACT PRICE: \$28,744.00

You are hereby notified to commence work on the referenced contract on or before _____, and shall fully complete all of the work of said contract within _____ consecutive calendar days thereafter. Your final completion date is therefore _____.

CITY OF REPUBLIC, MISSOURI

By: _____
_____, _____ Director

ACCEPTANCE OF NOTICE

Receipt of the foregoing Notice to Proceed is hereby acknowledged by by the undersigned this

_____ day of _____, 20____.

By: _____

Title



City of Republic Missouri
 213 North Main
 Republic, Missouri 65738-1472
 Phone: (417) 732-3100 Fax: (417) 732-3149

NOTICE AND INSTRUCTIONS TO BIDDERS/VENDORS REGARDING SECTIONS 285.525 THROUGH 285.550 RSMO

Pursuant to the State of Missouri's RSMO 285.530(1), No business entity or employer shall knowingly employ, hire for employment, or continue to employ an unauthorized alien to perform work within the State of Missouri.

As a condition for the award of any contract or grant in excess of five thousand dollars by the state or by any political subdivision of the state (e.g., City of Republic, MO) to a business entity, the business entity (Company) shall, by sworn affidavit and provision of documentation, affirm its enrollment and participation in a federal work authorization program with respect to the employees working in connection with the contracted services. Every such business entity shall sign an affidavit affirming that it does not knowingly employ any person who is an unauthorized alien in connection with the contracted services. [RSMO 285-530(2)]

The City of Republic, Missouri, in order to comply with sections 285.525 through 285.550 RSMO, requires the following bid and contract documents:

Required Affidavit for Contracts Over \$5,000.00 (US) –Company shall comply with the provisions of Section 285.525 through 285.550 RSMo. Contract award is contingent on Company providing an acceptable notarized affidavit stating:

1. that Company is enrolled in and participates in a federal work authorization program with respect to the employees working in connection with the contracted services; and
2. that Company does not knowingly employ any person who is an unauthorized alien in connection with the contracted services.

Copies of affidavit can be found and downloaded on the City of Republic Missouri Public Works website; <http://www.republicmo.com/publicworksdepartment> See *attached sample*

Additionally, Company must provide documentation evidencing current enrollment in a federal work authorization program (e.g., electronic signature page from E-Verify program's Memo of Understanding (MOU)). See *attached sample*

The City of Republic encourages companies that are not enrolled and participating in a federal work authorization program to do so. E-Verify is an example of this type of program. Information regarding E-Verify is available at http://www.dhs.gov/xprevprot/programs/gc_1185221678150.shtm or by calling **888-464-4218**.



CITY OF REPUBLIC, MISSOURI

AFFIDAVIT OF COMPLIANCE WITH SECTION 285.500 RSMO., ET SEQ. FOR ALL AGREEMENTS IN EXCESS OF \$5,000.00

STATE OF _____)
COUNTY OF _____) ss.

Before me, the undersigned Notary Public, in and for the County of _____, State of _____, personally appeared _____ (Name) who is _____ (Title) of _____ (Name of company), (corporation), (partnership), (sole proprietorship), (limited liability company), and is authorized to make this affidavit, and after being duly sworn did depose and say:

- (1) that said company is enrolled in and participates in a federal work authorization program with respect to the employees working in connection with the contracted services; and
(2) that said company does not knowingly employ any person who is an unauthorized alien in connection with the contracted services.

The terms used in this affidavit shall have the meaning set forth in Section 285.500 R.S. Mo., et seq.

Documentation of participation in a federal work authorization program is attached to this affidavit.

Signature

Printed Name

Subscribed and sworn to before me this _____ day of _____, _____.

Notary Public

My commission expires: _____

Company ID Number: XXXXXX

The foregoing constitutes the full agreement on this subject between the SSA, DHS (Department of Homeland Security), and the Employer.

The individuals whose signatures appear below represent that they are authorized to enter into this MOU on behalf of the Employer and DHS respectively.

To be accepted as a participant in E-Verify, you should only sign the Employer's Section of the signature page. If you have any questions, contact E-Verify Operations at 888-464-4218.

Employer, Your Company Name

John Doe

Name (Please type or print)

Title

Electronically Signed

Signature

Date

Verification

Department of Homeland Security Division

USCIS Verification Division

Name (Please type or print)

Title

Electronically Signed

Signature

Date



CITY OF REPUBLIC, MISSOURI

AFFIDAVIT OF COMPLIANCE WITH SECTION 292.675 RSMO. FOR ALL PUBLIC WORKS PROJECT CONTRACTS

STATE OF _____)
COUNTY OF _____) ss.

Before me, the undersigned Notary Public, in and for the County of _____, State of _____, personally appeared _____ (Name) who is _____ (Title) of _____ (Name of company), (corporation), (partnership), (sole proprietorship), (limited liability company), and is authorized to make this affidavit, and after being duly sworn did depose and say:

- (1) that said company, pursuant to 292.675 RSMo., has provided at minimum a ten-hour Occupational Safety and Health Administration (OSHA) construction safety program for their on-site employees which includes a course in construction safety and health approved by OSHA or a similar program approved by the department which is at least as stringent as an approved OSHA program, unless such employees have previously completed the required program.

The terms used in this affidavit shall have the meaning set forth in Section 292.675 RSMo.

Signature
Printed Name

Subscribed and sworn to before me this _____ day of _____, _____.

Notary Public

My commission expires: _____



ADDENDUM #01

RE: **Pavement for Animal Control Center Parking lot and Driveway**

To Whom It May Concern:

The purpose of this addendum is to inform you that the City of Republic is requesting an additional alternative bid for a larger portion of paved area than described in the original Invitation for Bid, approximately 13,107 SF of asphalt or concrete pavement. bidders are asked to submit a bid for both:

A) Approximately 7869 square feet of concrete or asphalt parking and driveway for Animal control center including 6 in. curb & gutter on both sides of the driveway from 1 ft behind storm pipe to edge of right-of-way (ROW), approximately 103 linear feet. Pavement in ROW shall be 8in bituminous asphalt, 8 in concrete, or 7 in reinforced concrete. all sub grade preparation will be completed by the city prior to contractor work beginning. See attached plans for details

And,

B) Approximately 13,107 square feet of concrete or asphalt parking and driveway for Animal control center including 6 in. curb & gutter on both sides of the driveway from 1 ft behind storm pipe to edge of right-of-way (ROW), approximately 103 linear feet. Pavement in ROW shall be 8in bituminous asphalt, 8 in concrete, or 7 in reinforced concrete. all sub grade preparation will be completed by the city prior to contractor work beginning. See attached plans for details

If a bidder submits for only one of these alternatives they may or may not be selected if they do not submit for the alternative the City of Republic chooses to move forward with. Bid opening will remain **Thursday, July 2, 2020 3:00pm** as stated on the advertisement. All other conditions of the bid shall remain the same.

Garrett Brickner

Assistant Community Development & Public Works Director

City of Republic

204 N. Main St. Republic, MO 65738

Phone: (417) 732-3405

Mission: "We will be aggressively progressive through *Processes, Relationships, and Trust*"



AGENDA ITEM ANALYSIS

Project/Issue Name: 20-R-25 A Resolution of the City Council of the City of Republic, Missouri, Authorizing the City Administrator to Enter Into an Agreement with Missouri State University for Services Related to the Comprehensive Plan.

Submitted By: Karen Haynes, Community Development Department

Date: July 21, 2020

Issue Statement

Consideration to approve a contract with Southwest Missouri Council of Governments (SMCOG) for the completion of the City's Comprehensive and Land Use Plans.

Discussion and/or Analysis

The City has identified the update of the City's Comprehensive Plan, last updated and adopted in May 1988, and the update of the City's Land Use Plan, last updated and adopted in September 2005, as high priority projects moving forward.

The Community Development Department's Planning Staff identified components of both projects to complete internally, including: Growth Management Project, Demographic Study, Commercial Land Use and Market Study, Preliminary Future Land Use Study, and the development of a Neighborhood Program.

SMCOG will take the lead, working closely with the Community Development Department's Planning Staff, to complete the remainder of the Comprehensive Plan and Land Use Plan Project, with a projected completion date in April 2021. SMCOG will organize and facilitate Public Hearings required for consideration of adoption; facilitate Land Use Planning Meetings to identify land use goals, objectives, and final development of a Future Land Use Map; conduct an Industrial Market Study; compose the Comprehensive Plan and Land Use Plan documents; organize and execute a Public Open House for Plan review; and assist in the presentation of the Plans for consideration of adoption to the Planning & Zoning Commission.

A proposed Budget Amendment in early Fall 2020 will appropriate the funds, totaling \$29,350, from the General Fund for the cost associated with the completion of the City's Comprehensive and Land Use Plan.

Recommended Action

Staff recommends the approval of the contract with Southwest Missouri Council of Governments (SMCOG) for the completion of the City's Comprehensive and Land Use Plans.

RESOLUTION NO. 20-R-25

A RESOLUTION OF THE CITY COUNCIL OF THE CITY OF REPUBLIC, MISSOURI, AUTHORIZING THE CITY ADMINISTRATOR TO ENTER INTO AN AGREEMENT WITH MISSOURI STATE UNIVERSITY FOR SERVICES RELATED TO THE COMPREHENSIVE PLAN

WHEREAS, the City of Republic, Missouri, ("City" or "Republic") is a municipal corporation and Charter City located in Greene County, Missouri, being duly created, organized and existing under the laws of the State of Missouri; and

WHEREAS, the City desires a qualified firm to provide additional resources for the Comprehensive Plan related to Land Use; and

WHEREAS, the City Council desires to engage the Southwest Missouri Council of Governments (SMCOG) through Missouri State University for services for the Comprehensive Plan.

NOW, THEREFORE, BE IT RESOLVED BY THE CITY COUNCIL OF THE CITY OF REPUBLIC, MISSOURI, AS FOLLOWS:

- Section 1. The Agreement submitted by the Southwest Missouri Council of Governments (SMCOG) for services related to the City’s Comprehensive Plan, attached hereto as Attachment 1 and incorporated herein, is accepted at the unit prices shown thereon and not to exceed \$29,350.00 subject to certain adjustments as outlined in the Agreement.
- Section 2. The City Administrator, or designee, on behalf of the City, is authorized to take the necessary steps to implement this Resolution.
- Section 3. The whereas clauses are hereby specifically incorporated herein by reference.
- Section 4. This Resolution shall take effect and be in force from and after its passage as provided by law.

PASSED AND APPROVED at a regular meeting of the City Council of the City of Republic, Missouri, this 21st day of July 2020.

Jeff Ussery, Mayor

Attest:

Laura Burbridge, City Clerk

Approved as to Form:  Digitally signed by Scott Ison
Date: 2020.07.20 11:45:37 -05'00', Scott Ison, City Attorney

Final Passage and Vote: _____

Missouri State UNIVERSITY

901 S. National Avenue
Springfield, MO 65897

PROFESSIONAL SERVICES CONTRACT

CLIENT NAME: City of Republic, MO	CONTACT: Andrew Nelson
ADDRESS: 204 N Main Ave Republic, MO 65738	TELEPHONE NUMBER: 417-725-5850
	EMAIL: anelson@republicmo.com

GENERAL CONTRACT INFORMATION

MISSOURI STATE UNIVERSITY (Contractor) CONTACT PERSONNEL:

Technical: Brandon Jenson (SMCOG)
Phone: 417-836-6973
Email: brandonjenson@missouristate.edu

Administrative: Janene Proctor (MSU)
Phone: 417-836-8419
Email: janeneproctor@missouristate.edu

CONTRACT TITLE: City of Republic Comprehensive Plan

CONTRACT PERIOD: July 21, 2020 – March 31, 2021

CONTRACT AMOUNT: \$29,350

DEBARMENT CERTIFICATION: The Client certifies that it and its principals are not presently debarred, suspended, proposed for debarment, declared ineligible, or voluntarily excluded from covered transactions by any Federal Department or Agency.

DESCRIPTION OF SERVICES: See attached Attachment A

CANCELLATION POLICY: Should there be a need by the University or Client to cancel this contract, it will be mutually understood that no fees will be paid; reasonable and necessary expenses incurred prior to the cancellation will be addressed on a case-by-case basis.

PAYMENT PROCESS: Fixed Price – \$8,700 payment due upfront, \$4,500 payment due after outside services rendered, and final \$16,150 payment due after all services rendered.

APPROVED AND ACCEPTED:

MISSOURI STATE UNIVERSITY
ON BEHALF OF SMCOG

CLIENT: CITY OF REPUBLIC

Signature

Signature

VP for Research & Economic Development
Title

Title

Date

Date

Attachment A

Sponsored Program

1. **Title Program:** City of Republic Comprehensive Plan Update
2. **Program Director:** Brandon Jenson
3. **Program Description:**

The Southwest Missouri Council of Governments (SMCOG) is a regional planning commission based in Springfield, Missouri and serves a ten-county area. SMCOG is administered by the Center for Resource Planning and Management at Missouri State University. All staff are employees of the University but serving on behalf of SMCOG.

We have been a leader in planning efforts in Missouri, including transportation planning and economic development services, since our re-organization in 1989. We have made every effort to provide your community with an effective yet highly efficient project that we feel will more than meet your needs.

PROCESS & TENTATIVE TIMELINE

Months 1 -3 (July – September):

Organization and Information Gathering. Staff will work with city staff and other local organizations to gather information pertinent to the planning effort. Staff and student workers will review work previously completed by the City, including plans, demographic analyses, and market studies. A Comprehensive Planning Committee (CPC) composed of community volunteers will be established during this phase.

Orientation Meeting & Survey. This public meeting will inform the CPC and community members of the general purpose and process of planning. Staff will present relevant data collected to-date and finalize an online community survey, specifically related to land use, to be distributed to residents of the community. The survey will be set to go live in late September. Staff will create new and incorporate existing base maps to use throughout the planning process.

Months 3-4 (September - October):

Survey Results & SWOT. The CPC will meet to review results from the community survey. SMCOG staff will facilitate a SWOT analysis to identify what the community's strengths and weaknesses are in order to begin identifying community goals.

Land Use Planning Meetings. Staff will facilitate two meetings to identify land use goals and objectives, and to discuss possible future land use scenarios and build consensus among the CPC to develop a future land use map. The map will reflect land use goals discussed previously.

Months 5-7 (November - January):

Writing the Plan. The SMCOG staff will write the land use plan, summarize existing plans and studies completed by the City, and compile into a single document. A draft will be provided to staff for initial review prior to the public open house.

Month 8 (February):

Public Open House - Draft Plan Review. Comments will be received at the meeting and revisions made to the document based on public input.

Month 9 (March):

Final Plan Presentation. The Plan will be presented to the Planning & Zoning Commission for their comments and adoption.

Next Council Meeting:

Adoption of Plan.

Online Engagement:

MSU/SMCOG staff will maintain the City's existing comprehensive plan website via Wix and perform social media management.

Industrial Market Study:

SMCOG will utilize a subcontractor to provide an industrial market study to inform the City's comprehensive plan update. A notice to proceed will be issued to the outside service provider upon this contract's execution. Final deliverables due from the outside service provider will include all collected data, presentation materials to convey the findings of the study, as well as a written report, and will be made available to the Client upon completion of outside services.

4. Program Schedule:

July 21, 2020 – March 31, 2021

5. Deliverables

- Meeting facilitation and community survey
- Maintenance of City's Comprehensive Plan website and social media for the duration of the contract period
- The City of Republic Comprehensive Plan Update Document (in digital form only)
- Wall maps and/or poster boards
- Final deliverables from industrial market study

6. Budget:

Scope of Services to be performed for a fixed fee of \$21,150 plus outside service costs of \$8,200.



Serving Barry, Christian, Dade, Dallas, Greene, Lawrence, Polk, Stone, Taney, & Webster Counties

Request for Proposals Industrial Market Study for the City of Republic, MO

The Southwest Missouri Council of Governments (SMCOG) is soliciting proposals from firms and/or individuals interested in offering sub-contractual services to produce an industrial market study for the City of Republic, MO, according to the Attachment 1 – Scope of Work. The study will be used to inform the SMCOG’s potential project to update the City’s comprehensive plan.

Respondents should include a timeline of all project objectives identified in Attachment 1 – Scope of Work; all work must be completed by October 16, 2020. Please also indicate the length of time for which the proposal is valid.

Interested firms/individuals that meet the requirements and desire to provide services shall email a proposal packet, to include all requested information as identified below, by Monday, June 29, 2020 at 5 pm to BrandonJenson@MissouriState.edu. It is entirely the respondent's responsibility to examine this RFP, and to submit a proposal in a complete and timely manner.

The firm or individual is expected to possess adequate organization, facilities, and personnel to ensure that services are provided to SMCOG in a prompt and efficient manner. The firm or individual must be available to SMCOG staff as needed, including email communication, conference calls, and special presentations conducted in-person or by conference calls as directed by SMCOG.

All proposals should provide the following information:

- Firm/individual name, office location, mailing address, telephone number, fax number and e-mail address;
- Firm’s Federal Employer ID Number or individual’s Social Security Number;
- Description and the history of the firm/individual;
- Description of individual personnel qualifications relevant to this project;
- Recent experience from the last ten (10) years demonstrating current capacity, familiarity, and expertise in best practices concerning work of a related nature. Experience that is similar in type to the Attachment 1 will be most useful;
- Three (3) references for which the firm/individual has performed services within the past two (2) years that are similar in nature to the Attachment 1;
- Timeline of work completion by project objective as listed in Attachment 1, with all work completed no later than October 16, 2020; and
- Proposed Fee Schedule as a lump sum cost.



Serving Barry, Christian, Dade, Dallas, Greene, Lawrence, Polk, Stone, Taney, & Webster Counties

The respondent shall pay for all materials, labor, tools and equipment, transportation, insurance, and all other services and facilities necessary to execute, complete, and deliver work; proposal estimates must be lump sum, and inclusive of all costs incurred by respondents.

SMCOG is an Equal Opportunity Employer and reserves the right to reject any and all proposals received. This project is dependent upon successful negotiation of a contract with the City; contract documents will include a contingency clause as such. If you have any questions, please contact Brandon Jenson, (417) 836-6973.

Sincerely,

A handwritten signature in black ink that reads "Brandon Jenson".

Brandon Jenson, AICP Candidate
Planner, Southwest Missouri Council of Governments



Serving Barry, Christian, Dade, Dallas, Greene, Lawrence, Polk, Stone, Taney, & Webster Counties

Attachment 1 Scope of Work

The purpose of this study is to examine the City of Republic's existing industrial market. The results of a Housing Needs Analysis and access to Residential and Commercial Land Use Inventory Surveys will be made available to inform this study. Focus will be on the projected service and employment area of the City of Republic, as well as the surrounding areas. Project objectives include the following:

- Identify existing commercial and industrial operators by segment;
- Identify current and future market demands for industrial and manufacturing growth by segment, with the latter based on a utilization of new home absorption;
- Identify what advantages and vulnerabilities the City of Republic faces; and
- Develop a comprehensive market-based strategy from the conclusions drawn in the Industry Market Study that includes a plan for implementation.

Final deliverables include all collected data, presentation materials to convey the findings of the study, as well as a written report that addresses all project objectives as identified above.

Serving Barry, Christian, Dade, Dallas, Greene, Lawrence, Polk, Stone, Taney, & Webster Counties

Andrew Nelson
City of Republic
213 N Main St
Republic, MO 65738

Re: Republic Comprehensive Plan Update

On behalf of the Southwest Missouri Council of Governments (SMCOG), it is my pleasure to present the following proposal for the City of Republic's Comprehensive Plan update.

PROCESS & TENTATIVE TIMELINE

August 1, 2020 – March 31, 2021

Months 1 -2 (August – September):

Organization and Information Gathering. Staff will work with city staff and other local organizations to gather information pertinent to the planning effort. Staff and student workers will review work previously completed by the City, including plans, demographic analyses, and market studies. A Comprehensive Planning Committee (CPC) composed of community volunteers will be established during this phase.

Orientation Meeting & Survey. This public meeting will inform the CPC and community members of the general purpose and process of planning. Staff will present relevant data collected to-date and finalize an online community survey, specifically related to land use, to be distributed to residents of the community. The survey will be set to go live in late September. Staff will create new and incorporate existing base maps to use throughout the planning process.

Months 2-3 (October - November):

Survey Results & SWOT. The CPC will meet to review results from the community survey. SMCOG staff will facilitate a SWOT analysis to identify what the community's strengths and weaknesses are in order to begin identifying community goals.

Land Use Planning Meetings. Staff will facilitate two meetings to identify land use goals and objectives, and to discuss possible future land use scenarios and build consensus among the CPC to develop a future land use map. The map will reflect land use goals discussed previously.



Serving Barry, Christian, Dade, Dallas, Greene, Lawrence, Polk, Stone, Taney, & Webster Counties

Months 3-5 (November - January):

Writing the Plan. The SMCOG staff will write the land use plan, summarize existing plans and studies completed by the City, and compile into a single document. A draft will be provided to staff for initial review prior to the public open house.

Month 6 (February):

Public Open House - Draft Plan Review. Comments will be received at the meeting and revisions made to the document based on public input.

Month 7 (March):

Final Plan Presentation. The Plan will be presented to the Planning & Zoning Commission for their comments and adoption.

Next Council Meeting:

Adoption of Plan.

Optional:

Online Engagement. MSU/SMCOG staff will maintain the City's existing comprehensive plan website via Wix and perform social media management. (Estimated work hours: 100)

Industrial Market Study Subcontract. MSU/SMCOG staff will solicit professional services for an industrial market study. City staff would be involved in contract awarding decision, but SMCOG staff will be responsible for subcontract management and performance. A time and effort contract with a not-to-exceed clause would be utilized, with subcontractor costs invoiced to the City. (Estimated work hours: 25)

SUBCONTRACTING

If the City chooses to utilize subcontracting services for the Industrial Market Study, SMCOG will procure services prior to contract execution. SMCOG will work with the City to develop the Request for Qualifications that SMCOG will utilize to bring the subcontractor on board. SMCOG will be responsible for managing contracts, final deliverables, and timeframes with the subcontractor. A copy of all final deliverables will be provided to the City.



Serving Barry, Christian, Dade, Dallas, Greene, Lawrence, Polk, Stone, Taney, & Webster Counties

BUDGET

The total hours for the base project without options included are 580, charged at the SMCOG member rate of \$30 per hour. The fixed fee for the base project would be \$17,400. Fee is inclusive of all project expenses (salaries, travel, etc.) except for subcontractual costs, which is estimated not to exceed \$10,000. This proposal does not include printing costs, as physical copies of the final document(s) will not be a project deliverable. A breakout of full costs is identified in the chart below.

Base Project Cost	Options	Options Cost	Total Cost to City
\$17,400	#1 – Online Engagement	\$3,000	\$20,400
	#2 – Industrial Market Study	Subcontract cost + \$750	\$18,150 + subcontract cost
	Both Options	Subcontract cost + \$3,750	\$21,150 + subcontract cost

Please contact me with any feedback on this proposal or with any questions you may have. Thank you for the opportunity to work with your organization.

Sincerely,

Jason Ray, AICP
 Executive Director, Southwest Missouri Council of Governments



AGENDA ITEM ANALYSIS

Project/Issue Name: 20-R-26 A Resolution of the City Council of the City of Republic, Missouri, Authorizing Task Order No. 9 with Burns & McDonnell to Develop and Evaluate the Current Rate Structure, Revenues, and Expenses of the Wastewater Fund to Provide Recommendations for Future Rates, Capital Improvements and Financial Sustainability.

Submitted By: Andrew Nelson, Community Development Director

Date: July 21, 2020

Issue Statement

Authorizing Task Order No. 9 with Burns and McDonnell to evaluate the impact of the capital improvement plan on the wastewater utility financial plan and rates.

Discussion and/or Analysis

The City of Republic is requesting Burns & McDonnell evaluate the financial impact of implementing the capital improvement plan adopted by the city and analyze our current rates and rate structure to determine feasibility of implementation. This financial impact assessment would also assist in the application for a State Revolving Fund Loan that the city will bring before council in the future to bring the Wastewater Treatment System into DNR compliance.

Recommended Action

Staff recommends approval of Resolution 20-R-26.

RESOLUTION NO. 20-R-26

A RESOLUTION OF THE CITY COUNCIL OF THE CITY OF REPUBLIC, MISSOURI, AUTHORIZING TASK ORDER NO. 9 WITH BURNS & MCDONNELL TO DEVELOP AND EVALUATE THE CURRENT RATE STRUCTURE, REVENUES, AND EXPENSES OF THE WASTEWATER FUND TO PROVIDE RECOMMENDATIONS FOR FUTURE RATES, CAPITAL IMPROVEMENTS, AND FINANCIAL SUSTAINABILITY

WHEREAS, the City of Republic, Missouri (herein called the "City" or "Republic") is a municipal corporation and Charter City located in Greene County, Missouri, being duly created, organized, and existing under the laws of the State of Missouri; and

WHEREAS, the City, in Resolution 18-R-11, selected Burns & McDonnell Engineering Company, Inc. as the company to complete the water, wastewater and stormwater portions of the comprehensive plan; and

WHEREAS, during the comprehensive plan review, it was determined the need exists to evaluate the impact of the capital improvement plan on the wastewater utility financial plan and rates; and

WHEREAS, the Council finds the addition of this task to the comprehensive plan is needed and necessary for the future of the City.

NOW, THEREFORE, BE IT RESOLVED BY THE CITY COUNCIL OF THE CITY OF REPUBLIC, MISSOURI, AS FOLLOWS:

Section 1. The City Administrator, on behalf of the City of Republic, is authorized to enter into a Task Order Engineer-Owner Agreement, Task Order No. 9, with Burns & McDonnell Engineering Company, Inc, in the amount not to exceed \$27,000, for engineering services related to the evaluation of the impact of the capital improvement plan on the wastewater utility financial plan and rates, said Agreement to be in substantially the same form as "Attachment 1."

Section 2. The City Administrator, or designee, on behalf of the City, is authorized to take the necessary steps to execute this Resolution.

Section 3. The whereas clauses are hereby specifically incorporated herein by reference.

Section 4. This Resolution shall take effect after passage as provided by law.

PASSED AND APPROVED at a regular meeting of the City Council of the City of Republic, Missouri, this 21st day of July 2020.

Jeff Ussery, Mayor

Attest:

Laura Burbridge, City Clerk

Approved as to Form:  Digitally signed by Scott Ison Date: 2020.07.20 11:38:43 -05'00', Scott Ison, City Attorney

RESOLUTION NO. 20-R-26

Final Passage and Vote: _____

**TASK ORDER FOR
ENGINEER-OWNER AGREEMENT**

Task Order No. 9

This Task Order is entered into and authorized by Owner this day of July 2020, by and between City of Republic, Missouri (hereinafter called OWNER) and Burns & McDonnell Engineering Company, Inc. (hereinafter called ENGINEER).

The parties agree that the ENGINEER shall perform the following Services in accordance with the terms of the Engineer-Owner Agreement dated February 6th, 2018:

Scope of Services:

- A. Professional consulting services to evaluate the impact of the capital improvement plan on the wastewater utility financial plan and rates. Task Order 9, Exhibit B (attached) provides a defined scope of services for this Task Order.

Compensation:

- A. Amount of Payment:

- 1. For Services performed, OWNER shall pay ENGINEER as follows:

- a. For time spent by personnel, payment at the hourly rates indicated in the attached Exhibit C, "Schedule of Hourly Professional Service Billing Rates" Form BMR920. Such rates include overhead and profit. The rate schedule is effective to December 31, 2020, and will be increased annually thereafter.
- b. For photocopy, telephone, fax, normal computer usage and computer-aided drafting (CAD), and mail, a technology charge per labor hour as specified on the rate schedule in effect at the time the Service is provided.
- c. For expenses incurred by ENGINEER, such as authorized travel and subsistence, including airfare, food, lodging, automobile rental, commercial services, and incidental expenses, the cost to ENGINEER plus ten percent (10%).
- d. For reproduction, company vehicle usage, and testing apparatus, amounts will be charged according to the ENGINEER's standard rates in effect at the time the Service is provided.
- e. For Services rendered by other firms or individuals as subcontractors to ENGINEER, including but not limited to surveying, real property descriptions, soil borings, subsurface investigations, laboratory testing, field quality control tests, environmental data base search, photos, or other activities required or requested by OWNER, the same will be billed at the cost to ENGINEER plus ten percent (10%). Expenses incurred by such outside ENGINEERs in service to OWNER shall be reimbursable in accordance with 1.c. above.

- 2. Total payment for the Scope of Service described herein is not to exceed Twenty Seven Thousand Dollars (\$27,000.00) which amount shall not be exceeded without prior written consent of OWNER.
- 3. For additional, reduced, or changed Scope of Services, the amount of payment shall be adjusted on a mutually agreeable lump sum basis.

B. Statements:

- 1. Monthly statements will be submitted by ENGINEER to OWNER. Statements will be based on ENGINEER's estimated percent of Services completed at the end of the preceding month.
- 2. Statements will set forth: hours worked by each person, total hours worked and total labor billing, and a summary of expenses and charges. Upon request, documentation of reimbursable expenses included in the statement will be provided.

Time of Service:

- A. ENGINEER will proceed with providing the services set forth herein within approximately 10 days of the execution of this Task Order. It is anticipated that these services will be completed within approximately 120 days of the execution of this task order.
- B. Completing the services within the above time frame is contingent upon timely receipt of required information, approval and/or reviews.

Other Terms:

- A. The terms of this Task Order supersede any contrary terms of the Engineer-Owner Agreement.

IN WITNESS WHEREOF, the parties have made and executed this TASK ORDER as of the day and year first above written.

OWNER: City of Republic, Missouri

**ENGINEER: Burns & McDonnell
Engineering Company, Inc.**

By: _____

By:  _____

Name: _____

Name: Breck R. Washam, P.E. _____

Title: _____

Title: Vice President _____



Exhibit B – Task Order No. 9

Scope of Services - Wastewater Rate Analysis

9.1 Project Management and Coordination

- 9.1.1 ENGINEER will provide Administrative Assistance in the form of Project Management and Coordination as described in paragraph 3.1.4 as follows:
 - 9.1.1.1 Task Kick-Off Meeting – ENGINEER shall prepare agenda, minutes and host kick-off meeting for scope of services within Task Order No. 9. Kick off meeting to coordinate project goals, preferred communications, and schedule with the project team.
 - 9.1.1.2 Work Task Coordination – ENGINEER to provide general project management activities, including oversight and coordination of the contract and budget, schedule, quality control, and monthly invoice preparation for a maximum period of time not to exceed of 120 calendar days.
 - 9.1.1.3 ENGINEER shall develop a formal Request for Information (RFI) Log that communicates data request to and from OWNER and ENGINEER.
- 9.1.2 OWNER has designated the following person(s) to act as OWNER’S representative with respect to the services to be performed under this Task Order as described in paragraph 4.7:
 - 9.1.2.1 City Administrator: David Cameron
 - 9.1.2.2 Public Works Director: Andrew Nelson
 - 9.1.2.3 City Engineer: Garrett Brickner
 - 9.1.2.4 Wastewater Superintendent: Craig Lusby
 - 9.1.2.5 City Finance Director: Debbie Parks

9.2 Wastewater Financial Planning and Rate Analysis

- 9.2.1 ENGINEER will provide Economic Analysis as described in paragraph(s) 2.2.3 and 3.1.2 for SRF Loan Application of the Professional Services Agreement dated February 6th, 2018 with the following modifications.
 - 9.2.1.1 ENGINEER will assess the financial impact of the wastewater treatment plant expansion to assist the OWNER in determining its preferred funding strategy and inform the OWNER regarding the impact to wastewater rates.
 - 9.2.1.2 ENGINEER will meet with the OWNER to discuss the wastewater utility’s current financial position, develop an understanding of existing cost obligations, review any existing financial policies impacting the utility, and review potential funding strategy options. An initial data request will be prepared and submitted to the OWNER. Data required will include history on revenues, customers, and billed wastewater volumes; annual financial reports; budgets for operation and maintenance expenses; debt service schedules on existing debt; capital improvement plans, current rates, and beginning balances. Financial policies governing wastewater utility financial management will also be requested, such as targeted reserve balances and debt service coverage, as applicable.
 - 9.2.1.3 A five- to ten-year cash flow model will be developed to examine the sufficiency of wastewater revenues under existing rates to fund future operation and maintenance expenses, debt obligations, and capital projects. The cash flow model will be equipped with scenario capabilities to assess different capital

funding scenarios (i.e. debt issuance assumptions; cash vs. debt funding strategies, etc.) and terms. Proposed revenue increases will be forecasted based on the projected revenue requirements associated with capital improvement plans and funding strategies. Beyond improvements associated with the proposed wastewater treatment plant improvements, it is important to including funding requirements associated with other projects such as renewal and replacement to provide a financial plan that meets the needs of the utility for the foreseeable future.

- 9.2.1.4 Utilizing an across the board increase in rates, future rates and typical bills will be estimated to provide OWNER an understanding of the rate payer impact associated with the capital improvement plans. A comparison of bills under existing and potential future rates will be made for different customer types. Additionally, typical residential bills will be developed to compare the OWNER's existing and future wastewater bills with those of other communities in the region.
- 9.2.1.5 ENGINEER will prepare a draft report that summarizes the financial planning scenarios and estimated rate impacts, the methodology used, and assumptions included in the study. Feedback from the OWNER's review of the report will be incorporated as appropriate, and a final report will be provided. ENGINEER will present the findings to the OWNER.
- 9.2.1.6 Participate in preparation and attendance of up to two public meetings in support of SRF requirements.
- 9.2.1.7 Results of financial analysis will be used to aide in completion of the Fiscal Sustainability Certification Form (MO 780-2661).

Responsibilities of the OWNER:

1. Refer to Section 4 of the Professional Services Agreement dated February 6th, 2018.